

## DIN W48×H48mm Solid state ON Delay timer

### ■ Features

- DIN W48×H48mm
- Easy and simple time setting
- Cost-effective
- Easy time setting
- Wide range of time
- Power supply
- ATE : 110/220VAC 50/60Hz
- ATE1, ATE2 : 110VAC, 220VAC 50/60Hz, 12VDC, 24VDC(option)



**⚠ Please read "Caution for your safety" in operation manual before using.**

### ■ Ordering information

ATE	□	-	10	S
Item	Output	Time range	Time unit	
				S sec.(1, 3, 6, 10, 30, 60)
				M min.(3, 6, 10, 30, 60)
				H hour(3, 6, 12, 24)
			Number	Max. time range
			No mark	Time-limit SPDT(1c), Instantaneous SPST(1a)
			1	Time-limit DPDT(2c)
			2	Time-limit SPDT(1c), Instantaneous SPDT(1c)
			ATE	ON Delay timer

### ■ Specifications

Model	ATE -	<input type="checkbox"/> S <input type="checkbox"/> M <input type="checkbox"/> H	ATE1 -	<input type="checkbox"/> S <input type="checkbox"/> M <input type="checkbox"/> H	ATE2 -	<input type="checkbox"/> S <input type="checkbox"/> M <input type="checkbox"/> H
Function	<b>Power ON Delay</b>					
Control time setting range	sec.(1, 3, 6, 10, 30, 60), min.(3, 6, 10, 30, 60), hour(3, 6, 12, 24)					
Power supply	110/220VAC 50/60Hz		110VAC, 220VAC 50/60Hz, 12VDC, 24VDC(option)			
Allowable voltage range	90 to 110% of rated voltage					
Power consumption	Approx. 10VA(240VAC 60Hz), Approx. 2W(24VDC, 12VDC)					
Reset time	Max. 200ms					
Timing operation	Power ON start type					
Control output	Contact type	Time limit SPDT(1c), Instantaneous SPST(1a)		Time limit DPDT(2c)		Time limit SPDT(1c), Instantaneous SPDT(1c)
	Contact capacity	250VAC 3A resistive load				
Relay life cycle	Mechanical	Min.10,000,000 operations				
	Electrical	Min. 100,000 operations(250VAC 3A resistive load)				
Repeat error	Max. ±0.3%					
SET error	Max. ±5% ±0.05sec.					
Voltage error	Max. ±0.5%					
Temperature error	Max. ±2%					
Insulation resistance	100MΩ(at 500VDC megger)					
Dielectric strength	2000VAC 50/60Hz for 1 minute					
Noise strength	±2kV the square wave noise(pulse width : 1μs) by the noise simulator					
Vibration	Mechanical	0.75mm amplitude at frequency of 10 to 55Hz(for 1 min.) in each of X, Y, Z directions for 1 hours				
	Malfunction	0.5mm amplitude at frequency of 10 to 55Hz(for 1 min.) in each of X, Y, Z directions for 10 minutes				
Shock	Mechanical	300m/s <sup>2</sup> (approx. 30G) in each of X, Y, Z directions for 3 times				
	Malfunction	100m/s <sup>2</sup> (approx. 10G) in each of X, Y, Z directions for 3 times				
Environ-ment	Ambient temperature	-10 to 55°C, storage: -25 to 65°C				
	Ambient humidity	35 to 80%RH				
Unit weight	Approx. 75g					

※Environment resistance is rated at no freezing or condensation.

# Single Time Range Timer

## Parts description

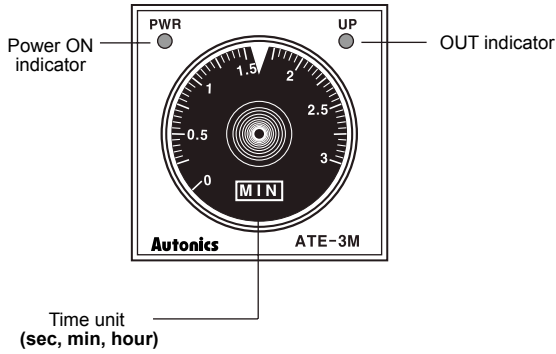

## Time setting range

Max. setting time	Setting range
1sec	0 to 1sec
3sec	0 to 3sec
6sec	0 to 6sec
10sec	0 to 10sec
30sec	0 to 30sec
60sec	0 to 60sec
3min	0 to 3min
6min	0 to 6min
10min	0 to 10min
30min	0 to 30min
60min	0 to 60min
3hour	0 to 3hour
6hour	0 to 6hour
12hour	0 to 12hour
24hour	0 to 24hour

## Output operation mode

t : Setting time, Rt : Reset time

Model	Time chart
ATE	
ATE1	
ATE2	

(A) Photo electric sensor

(B) Fiber optic sensor

(C) Door/Area sensor

(D) Proximity sensor

(E) Pressure sensor

(F) Rotary encoder

(G) Connector/Socket

(H) Temp. controller

(I) SSR/Power controller

(J) Counter

(K) Timer

(L) Panel meter

(M) Tacho/Speed/Pulse meter

(N) Display unit

(O) Sensor controller

(P) Switching mode power supply

(Q) Stepper motor& Driver&Controller

(R) Graphic/Logic panel

(S) Field network device

(T) Software

(U) Other

# ATE Series

## ■ Connections

### ● ATE Series

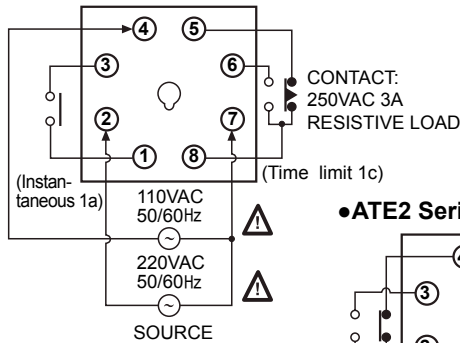

### ● ATE1 Series

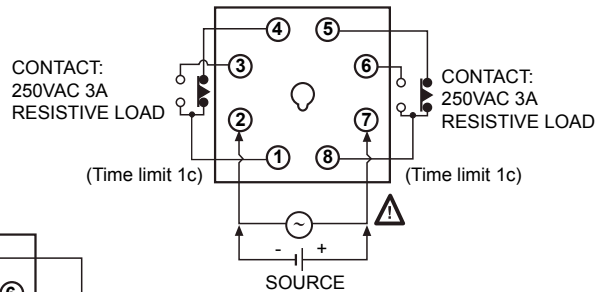

### ● ATE2 Series

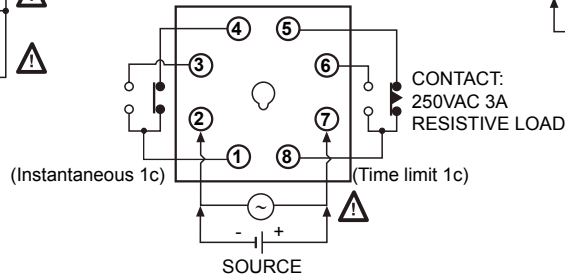

## ■ Dimensions

### ● Bracket (sold separately)

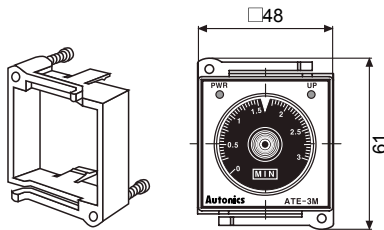

(Model: PGB48-W)

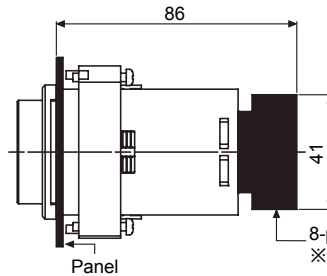
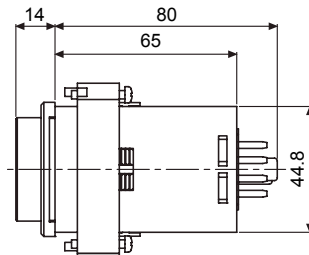

### ● Panel cut-out

(unit: mm)

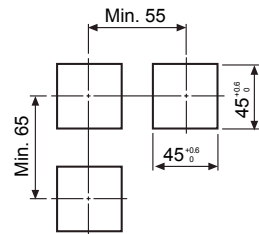

8-pin socket : PG-08(sold separately)  
 ※Refer to the G-15 page.

## ■ Proper usage

### ○ Environment

Please avoid the following places:

- A place where this product may be damaged by strong impact or vibration.
- A place where corrosive gas or flammable gas and water, oil, dust exist.
- A place where magnetic and electrical noise occur.
- A place where high temperature and humidity are beyond rated specification.
- A place where there are strong alkalis and acids.
- A place where there are direct rays of sun.

### ○ Noise

- We test 2kV, Pulse width 1 $\mu$ s against Impulse voltage between power terminals and 1kV, Pulse width 1 $\mu$ s at noise simulator against external noise voltage. Please install MP condenser(0.1 to 1 $\mu$ F) or oil condenser between power terminals when over impulse noise voltage occurs.
- When testing dielectric voltage and insulation resistance of the control panel with this unit installed.
- Please isolate this unit from the circuit of control panel.
- Please make all terminals of this unit short-circuited. (It prevents the damage of inner circuit.)