



## DTC Series Digital Controller Instruction Sheet

Thank you very much for purchasing DELTA DTC Series Temperature Controller. Please read this instruction sheet before using your DTC series to ensure proper operation, and please keep this instruction sheet handy for quick reference.

### ■ Caution

#### **DANGER! Caution! Electric Shock!**

DTC series is an OPEN-TYPE device and therefore should be installed in an enclosure free of airborne dust, humidity, electric shock and vibration. The enclosure should prevent non-maintenance staff from operating the device (e.g. key or specific tools are required to open the enclosure) in case danger and damage on the device may occur.

#### **WARNING!**

1. Prevent dust or metallic debris from falling into the controller that will cause malfunction. DO NOT modify or disassemble the controller. DO NOT use extra terminals.
2. Do not install and/or use the controller in places subject to:
  - (a) dust or corrosive gases and liquid
  - (b) high humidity and high radiation
  - (c) vibration and shock
3. Switch off the power when wiring or changing input sensors.
4. Be sure to use compensating wires that match the thermocouple types when extending or connecting the thermocouple wires.
5. Shorten the wire when wiring a platinum resistance thermometer (RTD) to the controller, and separate power cable from load wires to prevent interference and conductive influence.
6. Make sure the power cable and signals device are installed correctly before switching on the power of DTC; otherwise serious damage may occur.
7. DO NOT touch the terminals or repair the controller when the power is on to prevent electric shock.
8. Wait at least one minute after the power is off to allow the capacitor to discharge. DO NOT touch any internal circuit within this period.
9. DO NOT touch the internal terminals no matter the power is on or off.
10. DO NOT place other heating source (e.g. power supply) in parallel with DTC during the installation. Please keep proper space in between.

### ■ Model Name Explanation

DTC 1 2 3 4 5

Series name	DTC: Delta C series temperature controller	
<span style="border: 1px solid black; padding: 0 2px;">1</span> Controller position	1: First controller	2: Controller connected in parallel
<span style="border: 1px solid black; padding: 0 2px;">2</span> Auxiliary output groups	0: standard, 2 outputs, no auxiliary output 1: 1 auxiliary output. Not available now.	2: 2 auxiliary outputs. Not available now
<span style="border: 1px solid black; padding: 0 2px;">3</span> <span style="border: 1px solid black; padding: 0 2px;">4</span> Optional	00: Standard 01: CT input	02: EVENT input. Not available now
<span style="border: 1px solid black; padding: 0 2px;">5</span> Main output type	R: Relay output SPST, 250VAC, 3A V: Voltage pulse output 12V +10% ~ -20%	C: Current output 4 ~ 20mA L: Linear voltage output 0 ~ 10V

(DTC1000/2000 model): DC24V input, 2 outputs, relay output for output 2, RS-485 communication.

(DTC1001/2001 model): DC24V input, 1 output, 1 CT input, and RS-485 communication.

### ■ Function & Specification

Power supply	DC24V. Isolated switching power
Voltage range	Rated voltage: 90% ~ 110%
Power consumption	Rated 24 VDC, Max. 24 W combined, 3W + 3W x number of DTC2000 controllers (Max. 7)

Input sensors	Thermocouple: K, J, T, E, N, R, S, B, L, U, TXK
	Platinum RTD: Pt100, JPt100
	Linear DC input: 0 ~ 5V, 0 ~ 10V, 0 ~ 20mA, 4 ~ 20mA, 0 ~ 50mV
Sampling rate	Analog input: 0.15 sec. Thermocouple or platinum RTD: 0.4 sec.
Control method	PID, programmable PID, Manual, ON/OFF
Output types	Relay: SPST, Max. load 250VAC, 3A resistive load
	Voltage pulse: 12VDC, Max. output current: 40mA
	Current: DC 4 ~ 20mA (Load resistance: < 500Ω)
	Analog voltage: 0 ~ 10V (Load resistance: > 1,000Ω)
Output function	Control output, alarm output, proportional output Proportional output is available only when output 1 is linear voltage/current output.
Alarm	13 alarm modes
Communication	RS-485 digital communication, 2,400bps ~ 38,400bps
Communication protocol	Modbus protocol, ASCII/RTU format
Internal connection	Internal terminals available to transmit 24V power supply and communication signals
Vibration resistance	10 ~ 55Hz, 10m/s <sup>2</sup> for 10mins, each in X, Y and Z direction
Shock resistance	Max. 300m/s <sup>2</sup> , 3 times in each 3 axes, 6 directions
Ambient temperature	0 ~ 50°C
Storage temperature	-20 ~ +65°C
Altitude	< 2,000m
Ambient humidity	35% ~ 85% RH (non-condensing)
Pollution degree	2

## ■ Product Profile & Outline

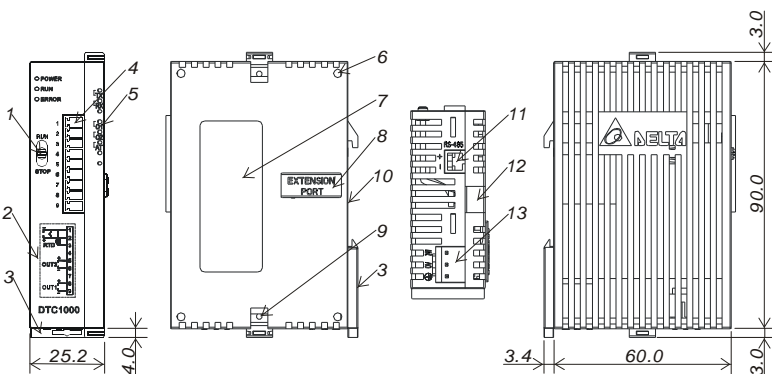

### DTC1000/1001 R/V/C/L

- |    |                           |
|----|---------------------------|
| 1  | RUN/STOP switch           |
| 2  | Wiring and Model name     |
| 3  | DIN rail clip             |
| 4  | I/O terminals             |
| 5  | LED indicators            |
| 6  | Mounting hole             |
| 7  | Specification label       |
| 8  | Extension port            |
| 9  | Extension clip            |
| 10 | DIN rail                  |
| 11 | RS-485 communication port |
| 12 | Extension clip            |
| 13 | DC power input            |

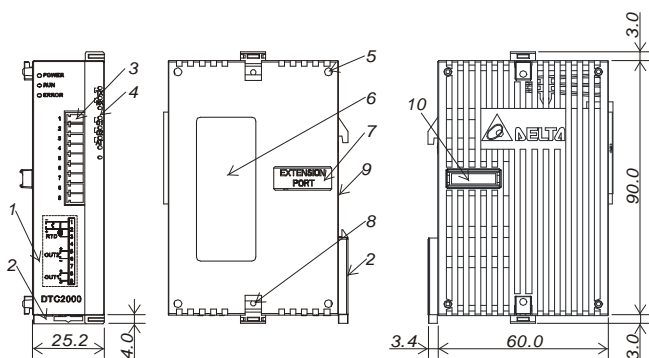

### DTC2000/2001 R/V/C/L

- |    |                       |
|----|-----------------------|
| 1  | Wiring and Model name |
| 2  | DIN rail clip         |
| 3  | I/O terminals         |
| 4  | LED indicators        |
| 5  | Mounting hole         |
| 6  | Specification label   |
| 7  | Extension port        |
| 8  | Extension clip        |
| 9  | DIN rail              |
| 10 | Extension port        |

## ■ Input

DTC series supports the following input sensors:

Input Sensor	Register Value	Available Range
0 ~ 50mV linear voltage input	17	0 ~ 50mV
4 ~ 20mA linear current input	16	4 ~ 20mA
0 ~ 20mA linear current input	15	0 ~ 20mA
0 ~ 10V linear voltage input	14	0 ~ 10V
0 ~ 5V linear voltage input	13	0 ~ 5V
Platinum RTD (Pt100)	12	-200 ~ 600°C (-328 ~ 1,112°F)
Platinum RTD (JPt100)	11	-20 ~ 400°C (-4 ~ 752°F)
Thermocouple TXK type	10	-200 ~ 800°C (-328 ~ 1,472°F)
Thermocouple U type	9	-200 ~ 500°C (-328 ~ 932°F)
Thermocouple L type	8	-200 ~ 850°C (-328 ~ 1562°F)
Thermocouple B type	7	100 ~ 1,800°C (212 ~ 3,272°F)
Thermocouple S type	6	0 ~ 1,700°C (32 ~ 3,092°F)
Thermocouple R type	5	0 ~ 1,700°C (32 ~ 3,092°F)
Thermocouple N type	4	-200 ~ 1,300°C (-328 ~ 2,372°F)
Thermocouple E type	3	0 ~ 600°C (32 ~ 1,112°F)
Thermocouple T type	2	-200 ~ 400°C (-328 ~ 752°F)
Thermocouple J type	1	-100 ~ 1,200°C (-148 ~ 2,192°F)
Thermocouple K type	0	-200 ~ 1,300°C (-328 ~ 2,372°F)

Note 1: The current input is built-in with 249Ω precision resistor. See "How To Set up Current Input" section.

Note 2: Default setting: Pt100 input.

The range of linear input and feedback value is adjustable. Range of input feedback: -999 ~ 9,999. Take 0 ~ 20mA input as example, -999 refers to 0mA input, and 9,999 refers to 20mA input. If we change the range to 0 ~ 2,000, 0 will refer to 0mA input, and 2,000 will refer to 20mA input. 1 display scale = 0.01mA.

## ■ Output

There are several output types available from DTC series: Control Output (heating/cooling), Alarm Output and Proportional Output.

### • Control Output

DTC series offers 2 outputs for heating or cooling control. If you require dual loop output, the 2 outputs should be set to different actions (heating or cooling). If you require the 2 outputs are set to the same control action, only the control cycle of output 1 will be valid, and the 2 outputs will act at the same time.

The control methods include: PID control, ON/OFF control, Manual control and programmable PID control.

Single Output Control:

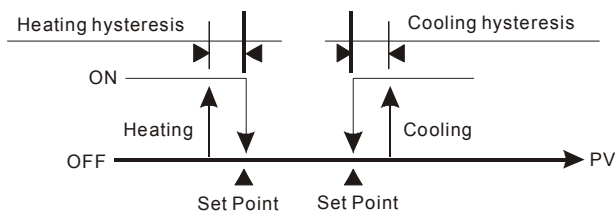

Figure 1: ON/OFF Control

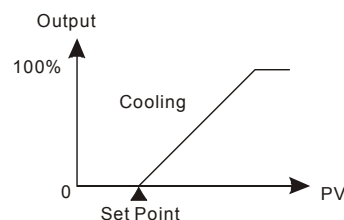

Figure 2: PID Control, Cooling Control

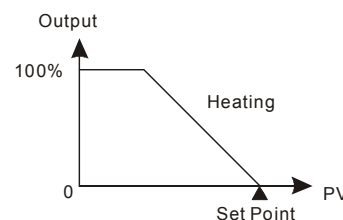

Figure 3: PID Control, Heating Control

Dual Output Control:

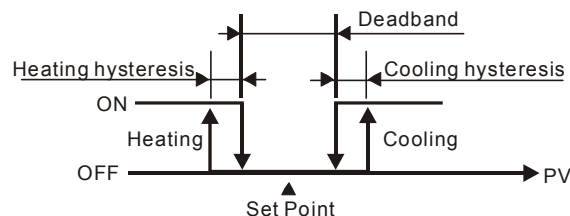

Figure 4: ON/OFF Control

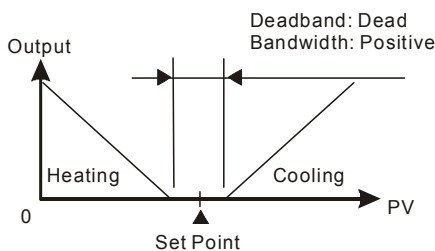

Figure 5: PID control

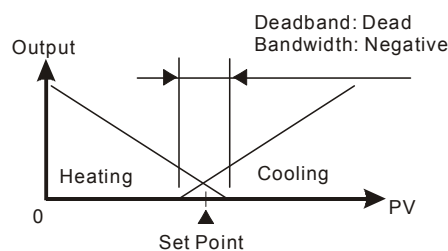

Figure 6: PID Control

### • Programmable PID Control & Parameters Setting

The programmable PID control includes 8 patterns (Pattern 0 ~ 7). Each pattern contains 8 steps (Step 0 ~ 7) and parameters: "link pattern", "cycle" and "the number of steps".

**Start Pattern:** The user can set up which pattern is the start pattern for the programmable control.

**Steps:** Includes the settings of the two parameters, set point X and execution time T, indicating that the set point (SV) has to rise to temperature X after the period of execution time T. If the result of the set point X is the same as that of the previous setting, the process is called "Soak"; otherwise, it is called "Ramp". Therefore, the programmable control is also known as Ramp/Soak control. The default setting of the first step is Soak control. The temperature will first rise to the set point X and remain at X. The total execution time is T.

**Link Pattern:** The pattern to be executed following the current pattern. If the setting is not 0 ~ 7, the set point will remain at the last pattern.

**Cycle:** The additional number of cycles for a pattern. For example, if the parameter is set to 2, it refers to the pattern has to execute additional twice, totaling the execution to 3 times including the original one.

**The Number of Steps:** The number of steps in each pattern (range: 0 ~ 7). For example, if the parameter is set to 2, it refers to the pattern will execute Step 0 ~ Step 2, and other steps will not be executed.

**The Execution:** Available settings include "run", "program hold", "program stop" or "stop".

1. When this parameter is set to "run", the program will start its execution from step 0 of the start pattern.
2. When this parameter is set to "program hold", the program will stop and the temperature will stop at the SV before the program stops. If the user sets to "run" again, the program will resume the step before the program stops and execute by the remaining time.
3. When this parameter is set to "program stop", the program will stop and the temperature will stop at the SV before the program stops. If the user sets to "run" again, the program will execute again from Step 0 of the start pattern.
4. When this parameter is set to "stop", the program will stop, and the control output will be disabled.

### • Proportional Output:

If Output 1 of this DTC series is linear voltage or current, the user can set it to "Proportional Output". Proportional output refers to the output varies with the input. For example, if the input range is set to 0 ~ 1,000, and when the input value is 0, the output will be 0mA or 0V. When the input value is 1,000, the output will be 20mA or 10V.

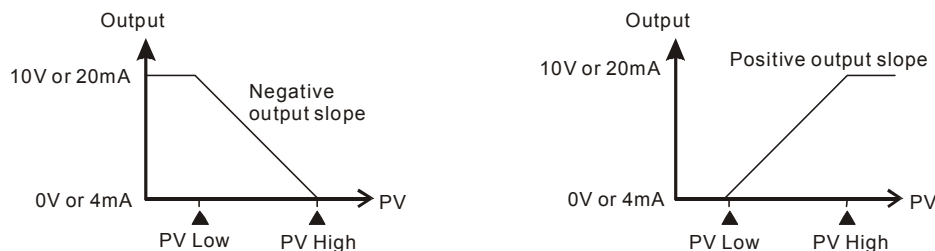

Figure 7: Proportional Output

## • Alarm Output

DTC series offers 13 alarm modes. When the PV exceeds or falls below SV, the alarm output will be enabled. See the table below for the 13 modes.

Mode	Alarm Type	Alarm Output Operation
0	No alarm	OFF
1	Alarm output will be enabled when the temperature reaches upper and lower limits. • Alarm will be enabled when the PV exceeds $SV + AL-H$ or falls below $SV - AL-L$ .	
2	Alarm output will be enabled when the temperature reaches the upper limit. • Alarm will be enabled when the PV exceeds $SV + AL-H$ .	
3	Alarm output will be enabled when the temperature reaches the lower limit. • Alarm will be enabled when the PV falls below $SV - AL-L$ .	
4	• Alarm will be enabled when the PV is between $SV + AL-L$ and $SV - AL-L$ .	
5	Alarm output will be enabled when the temperature reaches the absolute value of the upper and lower limits. • Alarm will be enabled when the PV exceeds $AL-H$ or falls below $AL-L$ .	
6	Alarm output will be enabled when the temperature reaches the absolute value of the upper limit. • Alarm will be enabled when the PV exceeds $AL-H$ .	
7	Alarm output will be enabled when the temperature reaches the absolute value of the lower limit. • Alarm will be enabled when the PV falls below $AL-L$ .	
8	Standby upper/lower limit alarm • Alarm will be enabled when the PV reaches SV and exceeds $SV + AL-H$ or falls below $SV - AL-L$ .	
9	Upper limit standby alarm • Alarm will be enabled when the PV reaches SV and exceeds $SV + AL-H$ .	
10	Lower limit standby alarm • Alarm will be enabled when the PV reaches SV and falls below $SV - AL-L$ .	
11	Upper limit hysteresis alarm • Alarm will be enabled when the PV exceeds $SV + AL-H$ and disabled when the PV falls below $SV + AL-L$ .	
12	Lower limit hysteresis alarm • Alarm will be enabled when the PV falls below $SV - AL-H$ and disabled when the PV exceeds $SV - AL-L$ .	
13	CT alarm output: • This alarm operates when the current measured by transformer (CT) is lower than $AL-L$ or higher than $AL-H$ .	

Note: AL-H and AL-L include AL1H, AL2H, AL1L and AL2L. When Output 1 is set to Alarm Output, use AL1H (1024H) and AL1L (1025H). When Output 2 is set to Alarm Output, use AL2H (1026H) and AL2L (1027H).

## ■ CT Function

- When CT is adopted, the communication address 106AH of the alarm output should be set to 02H only.
- When CT is adopted, the alarm mode should be set to 13 and the communication address 1021H to 0DH only.
- The user can adjust the upper limit and lower limit of CT Alarm. If the current detected by CT exceeds the upper/lower limit, ALM 2 will be set to "1".

1039H: Status of CT Alarm

1026H: Upper limit of CT Alarm (unit: 0.1A) Max. setting: 40.0A; Default setting: 100 (10.0A)

1027H: Lower limit of CT Alarm (unit: 0.1A) Min. setting: 0; Default setting: 5 (0.5A)

102BH: Current detected by CT (unit: 0.1A)

CT only measures current when there is control output; otherwise only the previous CT value will be displayed.

- When CT function is set, ALM1 can be set as well. However, if ALM1 is triggered and there is no alarm output, only the status of ALM1 will be displayed (see 102AH).

## ■ LED Display

- When power is normal, POWER LED will be on.
- After DTC is switched on, all LED will be on. The communication protocol will be displayed in 1 second, followed by the communication address in the next second.
- RUN LED is on when the control is executing.
- ERROR LED is on when errors occur in input, memory or communication.
- When an output is executing, its corresponding output LED will be on.
- AT LED flashes when PID parameters are being auto-tuned.
- RX LED flashes when DTC receives communication signals. TX LED flashes when DTC sends out communication signals.

Communication protocol displayed on LED after the power of DTC is switched on:

AT	TX	RX	O1	O2	Err	Run
000: 2,400bps 011: 19,200bps	001: 4,800bps 100: 38,400bps	010: 9,600bps	Parity 00: None 10: Odd	01: Even	0: ASCII 1: RTU	0:2 Stop bits 1:1 Stop bit

Communication address display: AT (bit 6) and Run (bit 0) are combined to binary code.

## ■ Password Function

The default setting of the password is disabled. To enable the password function, enter the 4-character password in the specific communication address. The password is protected by 3 levels.

- Level 1: Only LED status, SV and PV can be read. No settings can be modified.
- Level 2: Only LED status, SV and PV can be read. Only SV can be modified.
- Level 3: All SV can be read. Only SV and auto-tuning can be modified.
- Level 4: No password protection.

When a password is set (in 106EH ~ 1070H), the protection will enter Level 1. To enter other levels, enter the corresponding password (in 106BH ~ 106DH). After DTC is switched off, the protection will return to Level 1. To unlock the password protection, the user has to remove all the passwords (in 106EH ~ 1070H).

The password protection level can be read in 106EH ~ 1070H:

bit	b0	b1	b2	b3	b4	b5	b6
Status	Level 1	Level 2	Level 3	Level 1 locked	Level 2 locked	Level 3 locked	Unlocked

bit = 0 refers to no password is set. bit = 1 refers to the password has been set (b0 ~ b2). b3 ~ b6 display the current level status.

## ■ Synchronous Communication Protocol & Auto ID Setup

This function allows the user to set the communication protocol of DTC2000/2001 to the same protocol as set in the first DTC1000/1001. The station IDs of DTC are arranged in decreasing order. Follow the steps below.

- Set the auto communication ID of DTC1000/1001 to "1" (communication address: 1022H).
- Switch off DTC1000/1001 before connecting it to DTC2000/2001. Switch it on again.
- Default communication protocol: 9,600bps, 7 bits, Even, 1 stop bit, communication address 01.
- This function will consume 3 ~ 5 seconds more when you switch on your DTC.

## ■ RS-485 Communication

- Supports transmission speed: 2,400, 4,800, 9,600, 19,200, 38,400bps;
- Does not support 7, N, 1 / 8, E, 2 / 8, O, 2 communication format;
- Communication protocol: Modbus ASCII/RTU;
- Function code: 03H (read Max. 8 words in register), 06H (write 1 word into register), 01H (read Max. 16 bits of data), 05H (write 1 bit into register).

Address	Setting	Content	Explanation
1000H		Present temperature value (PV)	Unit: 0.1 degree. Analog input: 1EU. The read values below indicate the occurrence of errors: 8002H: Temperature not acquired yet 8003H: Temperature sensor not connected 8004H: Incorrect sensor type 8006H: Unable to acquire temperature, ADC input error 8007H: Unable to read/write the memory

Address	Setting	Content	Explanation
1001H	0	Set point (SV)	Unit: 0.1 degree. Analog input: 1EU.
1002H	6,000	Upper-limit of temperature range	The content shall not be bigger than the range. Unit: 0.1°
1003H	-200	Lower-limit of temperature range	The content shall not be smaller than the range. Unit: 0.1°
1004H	12	Input sensor type	See the table in "Input" section.
1005H	0	Control method	0: PID, 1: ON/OFF, 2: Manual, 3: programmable PID
1006H	0	Control method for Output 1	0: Heating (default); 1: Cooling; 2: Alarm; 3: Proportional (required analog output)
1007H	4	Control cycle of Output 1	0 ~ 99, 0: 0.5sec
1008H	4	Control cycle of Output 2	0 ~ 99, 0: 0.5sec (Invalid when the 2 outputs are the same control.) (DTC1000/2000 model)
1009H	476	Proportional band value	1 ~ 9,999, Unit: 0.1°. Analog input: 1EU
100AH	260	Ti value	0 ~ 9,999
100BH	41	Td value	0 ~ 9,999
100CH	0	Default integration value	0 ~ 1,000, Unit: 0.1%
100DH	0	Offset compensation value for proportional control (when Ti=0))	0 ~ 1,000, Unit: 0.1%
100EH	100	COEF setting when in dual control output	1 ~ 9,999, Unit: 0.01 (1000/2000 model)
100FH	0	Deadband setting when in dual control output	-999 ~ 9,999, Unit: 0.1° or 1EU (1000/2000 model)
1010H	0	Hysteresis of Output 1	0 ~ 9,999, Unit: 0.1° or 1EU
1011H	0	Hysteresis of Output 2	0 ~ 9,999, Unit: 0.1° or 1EU (1000/2000 model)
1012H	0	Read/write output percentage of Output 1	Unit: 0.1%. "Write" is only applicable in manual mode.
1013H	0	Read/write output percentage of Output 2	Unit: 0.1%. "Write" is only applicable in manual mode. (1000/2000 model)
1014H	0	Upper-limit regulation for analog linear output	1 scale = 2.8μA = 1.3mV
1015H	0	Lower-limit regulation for analog linear output	1 scale = 2.8μA = 1.3mV
1016H	0	Temperature offset regulation value	-999 ~ +999, Unit: 0.1° or 1EU
1020H	0	Output mode for Alarm 1	See "Alarm Output" section.
1021H	0	Output mode for Alarm 2	See "Alarm Output" section.
1022H	0	Communication flag auto-set	0: Communication banned, 1: Communication auto-set
1023H	0	Control method for Output 2	0: Heating (default); 1: Cooling; 2: Alarm (DTC1000/2000 model)
1024H	40	Upper limit for Alarm 1	See "Alarm Output" section.
1025H	40	Lower limit for Alarm 1	See "Alarm Output" section.
1026H	40	Upper limit for Alarm 2	See "Alarm Output" section. (1000/2000 model)
	100	Upper limit for CT Alarm	CT Alarm lower limit ~ 400, 1 scale = 0.1A (DTC1001/2001 model)
1027H	40	Lower limit for Alarm 2	See "Alarm Output" section. (DTC1000/2000 model)
	5	Lower limit for CT Alarm	0 ~ CT Alarm upper limit, 1 scale = 0.1A (DTC1001/2001 model)
102AH		Read/write status	b1: ALM2, b2: °C, b3: °F, b4: ALM1, b5: O2, b6: O1, b7: AT
102BH		Read current detected by CT	Unit = 0.1A (DTC1001/2001 model)
102CH	0	Positive/negative proportional output	0: positive, 1: negative
102EH		LED status	b0: RUN, b1: ERR, b2: O2, b3: O1, b4: RX, b5: TX b6: AT
102FH		Software version	V1.00 is indicated as 0x100
1030H	0	No. of start pattern	0 ~ 7
1032H		Remaining time of the executed step	Unit: second
1033H		Remaining time of the executed step	Unit: minute
1034H		No. of currently executed step	0 ~ 7
1035H		No. of currently executed pattern	0 ~ 7

Address	Setting	Content	Explanation
1036H		Read dynamic value in programmable control	
1037H	1,000	Upper limit of proportional output	0 ~ 100% upper limit of analog output, Unit: 0.1%
1038H	0	Lower limit of proportional output	0 ~ 100% lower limit of analog output, Unit: 0.1%
1039H		CT Alarm status	0: Disabled, 1: Enabled (DTC1001/2001 model)
1040H~1047H	7	Number of steps in a pattern	0 ~ 7 = N refers to the pattern will be executed from Step 0 to Step N.
1050H~1057H	0	Additional number of cycles for a pattern	0 ~ 199 refers to the pattern will be executed for 1 ~ 200 times.
1060H~1067H	0	No. of the link pattern for the current pattern	0 ~ 8, 8 refers to end of the program. 0 ~ 7 refers to the next pattern No. following the current pattern.
1068H	1	Run/Stop setting	0: Stop, 1: Run, 2: Program end, 3: Program hold
1069H	0	Control selection of Output 1	0: Heating, 1: Cooling, 2: Alarm, 3: Proportional output
106AH	0	Control selection of Output 2	0: Heating, 1: Cooling, 2: Alarm (1000/2000 model)
106BH	0	Unlock Level 1 password protection. Read/write allowed	Shall be the same as Level 1 password (106E)
106CH	0	Unlock Level 2 password protection. Use Level 3.	Shall be the same as Level 2 password (106F)
106DH	0	Unlock Level 3 password protection. Use Level 2	Shall be the same as Level 3 password (1070)
106EH	0	Unlock Level 1 password protection/Set up password	Unlock password before setting it up.
106FH	0	Unlock Level 2 password protection/Set up password	Unlock password before setting it up.
1070H	0	Unlock Level 3 password protection/Set up password	Unlock password before setting it up.
1071H	1	Read/write communication address	1 ~ 247
1072H	0	Read/write communication format	1: RTU, 0: ASCII
1073H	2	Read/write communication speed	0 ~ 4: 2,400 ~ 38,400
1074H	1	Read/write communication data length	0: 8 bits, 1: 7 bits
1075H	1	Read/write parity bit	0: None, 1: Even, 2: Odd
1076H	1	Read/write stop bit	0: 2 stop bits, 1: 1 stop bit
2000H~203FH	0	SV temperature for Pattern 0 ~ 7. SV for Pattern 0 is set in 2000H ~ 2007H	Unit: 0.1°
2080H~20BFH	0	Execution time for Pattern 0~7. Time for Pattern 0 is set in 2080H ~ 2087H	0 ~ 900 (1 scale = 1 minute)

5. Address and content of the bit register (read bits are stored starting from LSB, and written data is FF00H, set the bit as 1. 0000H sets the bits data to "0").

0811H	Temperature unit display	0:°F, 1: °C (Default)
0813H	Read/write auto-tuning status	0: End (Default), 1: Start
0814H	Run/Stop setting	0: Stop, 1: Run (Default)
0815H	Program hold flag	1: Program hold
0816H	Program stop flag	1: Program stop

6. Communication format: Command 01: read bit, 05: write bit, 03: read word, 06: write word.

• ASCII Mode

Read Command			Read Response Message			Write Command			Write Response Message		
Start word	'·'	'·'	Start word	'·'	'·'	Start word	'·'	'·'	Start word	'·'	'·'
Machine address 1	'0'	'0'	Machine address 1	'0'	'0'	Machine address 1	'0'	'0'	Machine address 1	'0'	'0'
Machine address 0	'1'	'1'	Machine address 0	'1'	'1'	Machine address 0	'1'	'1'	Machine address 0	'1'	'1'
Command 1	'0'	'0'	Command 1	'0'	'0'	Command 1	'0'	'0'	Command 1	'0'	'0'
Command 0	'3'	'1'	Command 0	'3'	'1'	Command 0	'6'	'5'	Command 0	'6'	'5'



Read Command			Read Response Message			Write Command			Write Response Message			
Read starting address of data/bit	'1'	'0'	Length of response data (byte)	'0'	'0'	Write data address	'1'	'0'	Write data address	'1'	'0'	
	'0'	'8'		'4'	'2'		'0'	'8'		'0'	'8'	
	'0'	'1'	Data content in 1000H/081xH	'0'	'1'		'0'	'1'		'0'	'0'	'1'
	'0'	'0'		'1'	'7'		'1'	'0'		'1'	'0'	
Read length of data/bit (word/bit)	'0'	'0'	Data content in 1001H	'F'	'0'	To write data content	'0'	'F'	Write data content	'0'	'F'	
	'0'	'0'		'4'	'1'		'3'	'F'		'3'	'F'	
	'0'	'0'	Data content in 1001H	'0'			'E'	'0'		'E'	'0'	
	'2'	'9'		'0'			'8'	'0'		'8'	'0'	
LRC1 check	'E'	'D'		'0'		LRC1	'F'	'E'	LRC1	'F'	'E'	
LRC0 check	'A'	'D'		'0'		LRC0	'D'	'3'	LRC0	'D'	'3'	
End word 1	CR	CR	LRC1 check	'0'	'E'	End word 1	CR	CR	End word 1	CR	CR	
End word 0	LF	LF	LRC0 check	'3'	'4'	End word 0	LF	LF	End word 0	LF	LF	
			End word 1	CR	CR							
			End word 0	LF	LF							

#### • LRC Check

LRC check sums up from "machine address" to "data content", e.g. 01H + 03H + 10H+ 00H + 00H + 02H = 16H. Obtain 2's complement EA.

#### • RTU Mode

Read Command			Read Response Message			Write Command			Write Response Message		
Machine address	01H	01H	Machine address	01H	01H	Machine address	01H	01H	Machine address	01H	01H
Command	03H	01H	Command	03H	01H	Command	06H	05H	Command	06H	05H
Read start address of data	10H	08H	Length of response data (byte)	04H	02H	Write data address	10H	08H	Write data address	10H	08H
	00H	10H					01H	10H		01H	10H
Read length of data (bit/word)	00H	00H	Data content 1	01H	17H	Write data content	03H	FFH	Write data content	03H	FFH
	02H	09H		F4H	01H		20H	00H		20H	00H
CRC low byte	C0H	BBH	Data content 2	03H		CRC low byte	DDH	8FH	CRC low byte	DDH	8FH
CRC high byte	CBH	A9H		20H		CRC high byte	E2H	9FH	CRC high byte	E2H	9FH
			CRC low byte	BBH	77H						
			CRC high byte	15H	88H						

#### • CRC Program Example

```

unsigned int reg_crc = 0xffff; i = 0;
while (length--)
{
    reg_crc ^= RTUData[j];
    i++;
    for (j = 0; j < 8; j++)
        {
            if (reg_crc & 0x01) reg_crc = (reg_crc >> 1) ^ 0xA001;
            else reg_crc = reg_crc >> 1;
        }
}
return(reg_crc);

```

## ■ Installation

How to connect maximum 8 DTC1000/2000 controllers by using DIN rail.

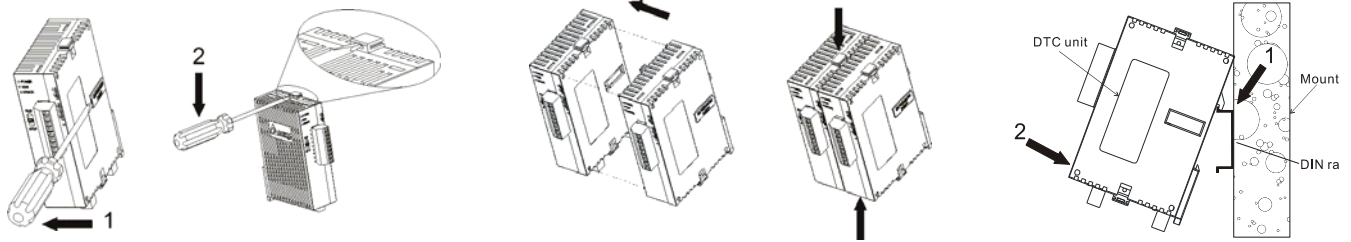

## ■ How to Set Up Current Input

For general input

For current input (4 ~ 20mA, 0 ~ 20mA)

