

Temperature Controller SUN-15T User Manual			
Model	Temperature Range		Output
SUN-15T	IC	-50 ... 125 °C	Main Relay(OUT1)/ AUX Relay (OUT2)
	K type (CA)	-200 ... 1300 °C	
	PT100	-200 ... 400 °C	
※ The User Manual is provided for preventing the damage and trouble of product caused by carelessness and to inform the precise usage.		<input type="checkbox"/> Equipment protected throughout by DOUBLE INSULATION of Reinforced Insulation ~ Alternating Current Supply	

1. Description of Display

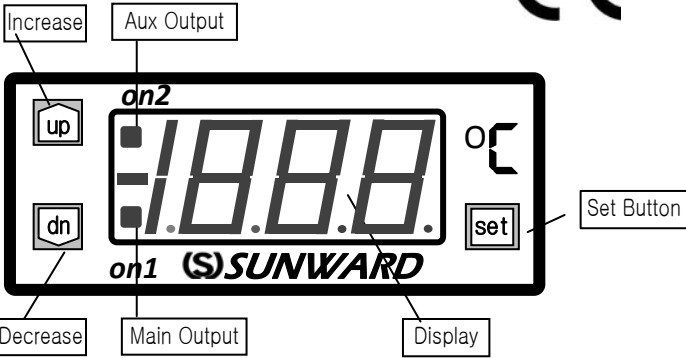

Display Unit	Displays Current Temperature or User-set temperature	
Main /Aux Output	Indicates the main or auxiliary output is ON or OFF	
Setting Button		Temperature Installer Setting Button
Increase Button		Setting Value increase button
Decrease Button		Setting Value decrease button

2. Capabilities and Applications of Product

- ▶ Power Controller for heater and cooler . Hysteresis 0.0~19.9°C for IC sensor and PT100 models and 0~50°C for K-Type models.0~240Sec delay timer , Normal(heating)/ Reverse(Cooling) selection.
- ▶ Contains general purpose digital Timer,1~999Minute.(e.g. defrosting usage)
- ▶ User configuration control .You can specify a valid temperature range that user is allowed to use. You can prevent a user from changing the setting of hysteresis, Delay timer and normal/reverse .

3. How To Set Main Output

- ▶ Supply power to the controller. It displays the current temperature.
- ▶ Press **Set** button once to set Main output Temperature value on the display is flashing.
- ▶ To change them, press **UP** or **Dn** Key. If you hold **UP/Dn** longer than 1 sec Increases or decreases quickly
 ※The selectable range might be limited by user configuration control.
- ▶ If you press **Set** for 5 seconds, the set Temperature will be saved. Even if switched-off, the set value will not be deleted.
- ▶ The current Temperature is displayed and controller starts to control.
- ▶ Main output N.O. use terminals 9~10.
- ▶ Auxiliary output use terminals 5,6 (see section13)

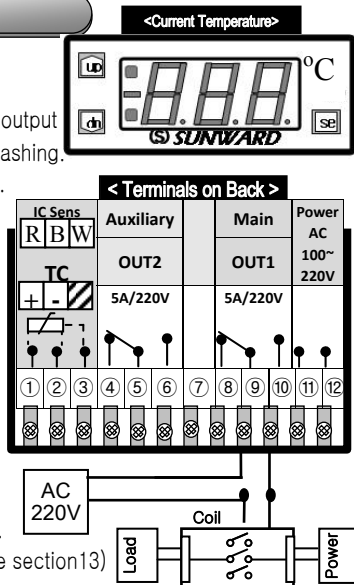

4. How to Connect Sensor

① sensor connection method

▶ Please connect as the right picture If you connect with the changed wired or use different type sensor 'Err' to be displayed.

② sensor wire extension method

▶ A Pt100 sensor line can be extended Up to 100M . IC sensor extending cable length limited to 30M.(Shielded cable is advised, to prevent input noise)

③ Sensor Reading compensation

When current temperature is incorrect, + RTD K Type TC IC Sensor

▶Hold **SET** key for longer than 5 sec.

When the display unit shows current temperature .

▶Release the key when **dIF** is displayed. Select proper **rSt** by pressing **UP** or **Dn** key.

▶Store the setting in memory by holding the **SET** key for longer than 5sec.

For example :

Current Temperature	+	rSt Temperature	=	Displayed Temperature
20 °C		-5 °C		15 °C
20 °C		10 °C		30 °C

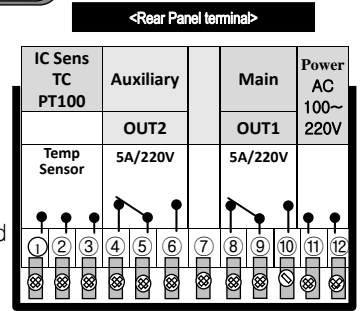

5. External & Panel Dimension

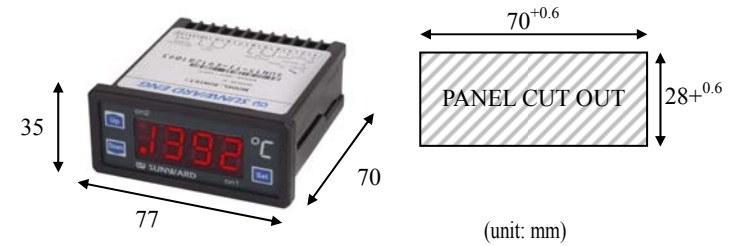

6. Product Specification

ITEM	Specification	
Supply Voltage	100~240VAC- 50~60Hz	12~24VDC
Power	MAX. 3W	
Input Sensor	IC (-50~125°C) K-TYPE (CA) (-200 ~ 1300°C) PT100 (-200 ~400°C)	
Accuracy	IC, 0.1°C for the entire range K-TYPE (CA), 1°C for the entire range PT100, (0.1°C : -200~200°C) (1°C : 200~400°C)	
Hysteresis	0.1~ 19.9°C for IC and PT100 Sensor 1 ~50°C for K-Type sensor	
Control Output	Relay output (AC250VAC , 5A)	
Control Operation	ON / OFF Control	
Ingress Protection	IP55	
Setting Method	Digital method with Up or Down key	
etc.	Sensor Input Correction , Delay Timer , Normal/Reverse logic, Timer Output(defrosting)	
Environment	Temperature : 0 ~ 50°C Humidity : 85% or less	

Attention - Manufacturer is not responsible for any misusages.

Maintenance and Service - It is recommended to use an excess temperature alarm system to protect your process against the probable dangers.
 - This product is intended to be used as temperature control and the manufacturer is not responsible for any uses except that.
 - For any services refer to the supplier and for the authorized (official) service centers refer to the following address.

- For maintenance and service note to the section 15 of the document too.

Manufactured and supported by: D P S A Co. LTD, www.sunward.info, info@sunward.info

7. Hysteresis setting

▶ To change hysteresis hold **SET** key for longer than 5 seconds . Release the key when the display unit shows **diF** .

▶ Set the configuration as following using **UP** and **Dn** keys.

dIF	Input Sensor	Setting	Description
User	PT100 & IC	0.1~19.9	Prevent Relay Vibration From Hysteresis
Settings	K- Type	1~50°C	

▶ Store the setting in memory by holding the **SET** key for longer than 5 sec .

▶ Description of ON/OFF control based on hysteresis value :

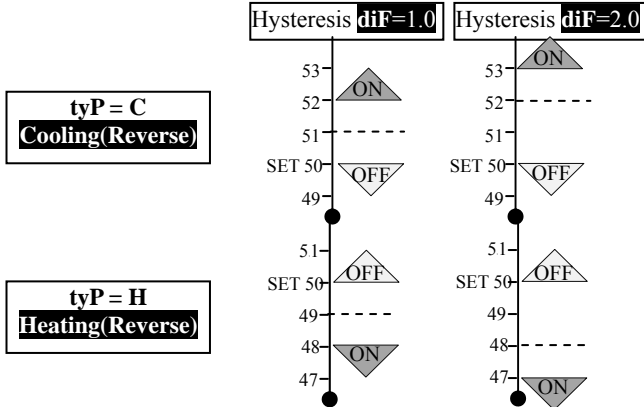

8. Normal / Reverse Output

tyP	Item	Setting	Description
User	tyP	C	Control The Cooler (Reverse Output)
Settings		H	Control The Heater (Normal Output)

① Cooler ON/OFF control

▶ When the current temperature becomes higher than a configured temperature, the main output relay turns on.

▶ You can use a delay timer to protect a compressor. (in refrigeration usage)

② Heater ON/OFF control

▶ When the current temperature becomes lower than a configured temperature, the main output relay turns on.

Note: In general, the B contact of a relay is used for reverse Output. In this case, be cautious the contact B is ON even though the power to the unit is turned off. (for example)

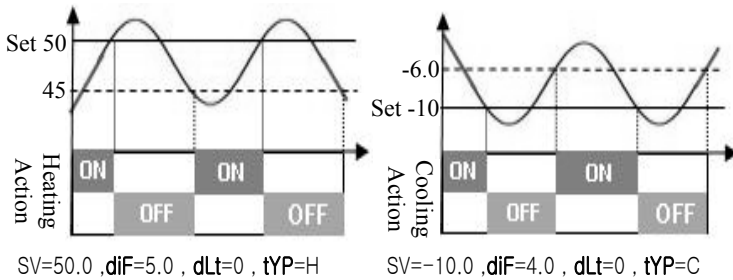

9. Delay Timer Setting

▶ In order to change the delay timer setting, Hold **SET** key for longer than 5 seconds while the display unit shows the current temperature. Release the key when the display unit shows **diF**. Press **SET** key several times to select **dLt**.

▶ After selecting a value using **Up** or **Dn** key, press **SET** key to store the setting in the memory.

Description: When the delay time expires, the output turns on.

User	Item	Setting	Description
Settings	dLt	0~240Sec	Output Becomes ON After Specified Time

▶ How the delay timer works

The delay time is 0 second => the relay turns on as soon as output signal arrives. (dLt=0)

The delay time is 5 second => the relay turns on after 5 sec once output signal arrives. (dLt=5)

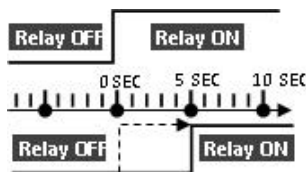

10. User Configurable Settings

▶ The following diagram shows configurable items. Select an item by pressing **SET** key.

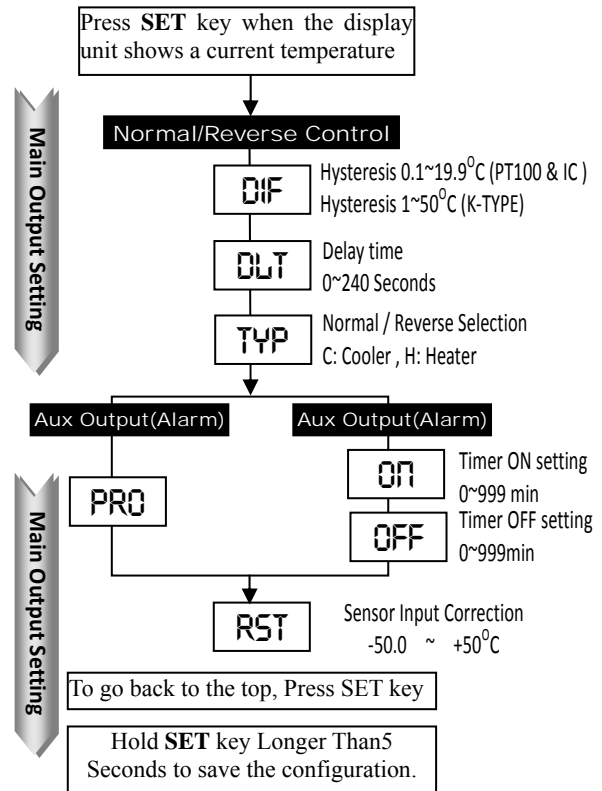

11. User Configurable Settings

▶ Make a note of factory default settings before changing any one of them. Before making any change, understand and verify the validity of your setting(s).

▶ Invalid settings may require service from the manufacturer.

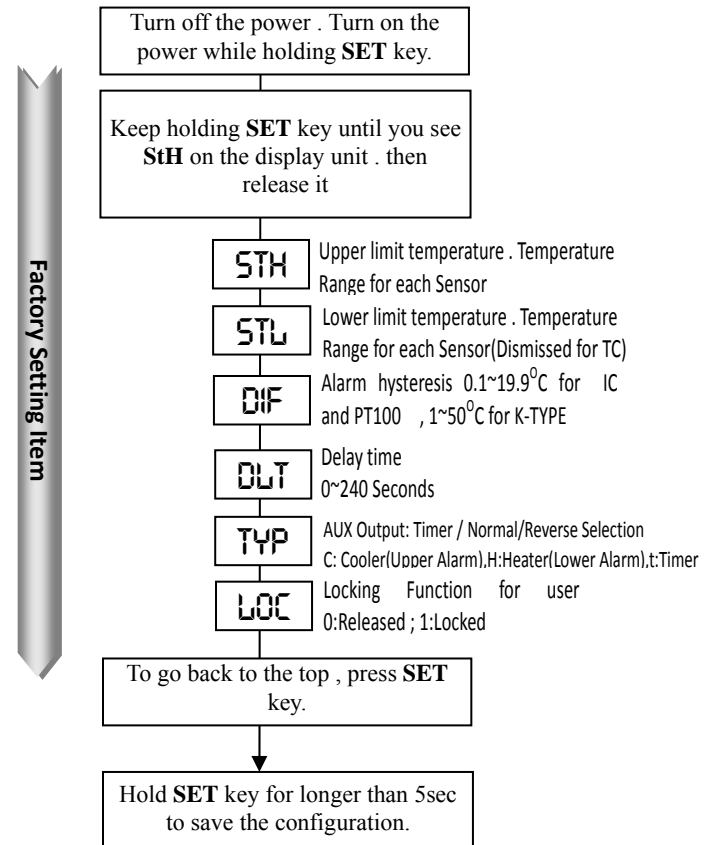

12. Configuration lock

① You can prevent a user from changing a pre-set configuration.

▶ Turn off the power while pressing set key. keep Holding SET key until you see StH on the display unit you.

▶ Press SET key several times to select LoC . Set the configuration as following using Up and Dn keys.

Factory Setting	Item	Set	Description
LoC	0		Unlocked (User can change setting)
	1		Locked (User can't change preset config.)

▶ Hold SET key for longer than 5 seconds to save the configuration. Note: After this configuration, the main temperature can be set only within the range of 40 to 50 degree.

② You can specify the range of temperature that a user can set .

▶ Turn off the power. Turn on the power while holding SET key .Keep holding SET key until you see StH on the display unit.

▶ Press SET key several times to select StL .Set the configuration as following using Up and Dn keys.

Factory Setting	Item	Set	Input	Description
StH		400 / 125	Pt100, IC	The highest value of temperature is 400 (Pt100) /125°C (IC)
		1250	K-TYPE	The highest value of temperature is 1200°C
StL		-200 / -50	Pt100, IC	The lowest value of temperature is -200 (Pt100) / -50°C(IC)

▶ Hold SET key for longer than 5 sec to save the configuration. Note : After this configuration ,the main temperature can be set only within above ranges.

13.How to set Alarm Output (Auxiliary Output)

① Set the auxiliary relay Output to Alarm Output (timer in next section)

▶ The auxiliary relay operates either as Alarm Output or as timer output . (alarm output is factory default setting)

▶ You MUST turn off power to change the factory setting.

▶ Turn on the power while holding SET key. and keep holding SET key.

▶ Release the set key when the display shows StH.

▶ Press SET key several times until you see tyP.

▶ To set the configuration as following, use Up and Dn keys.

Factory Setting	Item	Set	Description
tyP	H		Auxiliary Output As Alarm Low
	C		Auxiliary Output As Alarm High

▶ Store the setting in memory by holding the SET key for longer than 5 seconds.

② How to set alarm output temperature.

▶ When the display shows current temperature, hold SET key for longer than 5 seconds release the SET key when the display shows diF.

▶ Select Pro by pressing set key several times.

▶ If Pro is not displayed, you have to set auxiliary output as alarm state. (refer to the item 1 above, it shows the auxiliary output set as timer)

▶ To set the configuration as following, use Up and Dn keys .

Example Setting	Item	Set	Description
Pro	100.0		Alarm Output is set to 100°C (IC,PT100)
	0.0		Alarm Output is set to 0.0°C (TC)

▶ Store the setting in memory by pressing SET key for longer than 5 sec .

③ How to set alarm high or low

▶ To change the factory setting, you MUST turn off the power.

▶ Turn the power ON while holding SET key. and keep holding the set key.

▶ Release the key when you see StH on the display unit.

▶ Select tyP by pressing SET key several times.

▶ To Set the configuration as following, use Up and Dn keys .

▶ Hold set key for longer than 5 seconds to save the configuration .

Factory Setting	Item	Set	Description
tyP	H		The output is turned on when the current temperature becomes lower (TC)
	C		The output is turned on when the current temperature becomes higher (IC , Pt100)

④ How to disable the alarm output

▶ When you want to turn off alarm relay output, Follow the procedure described below.

▶ Hold SET key for longer than 5 seconds(when the display shows a current temperature) release the key when you see diF.

▶ Press SET key several times to select Pro.

▶ Select either the highest value or lowest value using Up or Dn key.

Setting	Item	Set	Description
Pro		-50.0 / 150.0	The configuration disables the alarm output (-50 for H and 150 for C)

▶ Hold SET key for longer than 5 seconds to save configuration.

14.Timer Setting

① How to set the auxiliary relay to the timer output

▶ The auxiliary relay select either the alarm output or timer output. As a factory setting, the relay is set to the alarm output.

▶ To change the factory setting you MUST turn off power .

▶ Turn on the power while holding SET key. and keep holding SET key.

▶ Release the set key when the display shows StH

▶ Press SET key several times until you see tyP.

▶ To set the configuration as following, use Up and Dn keys.

Factory Setting	Item	Set	Description
tyP	t		Use the auxiliary relay as the timer output

▶ Hold SET key for longer than 5 seconds to save the configuration.

② How to set timer value:

▶ When display shows the temperature , Hold SET key for longer than 5 seconds. Release the SET key when you see diF on display .

▶ Press SET key several times, to get on . if on does not appear , the auxiliary output is not selected as the timer output .See part ① in above paragraph .

▶ Set the configuration as following using Up or Dn keys.

Example Setting	Item	Set	Description
on		5	The output will be ON for 5min after a 15 min OFF period .
oFF		15	The output will be OFF for 15min after a 5 min ON period .

▶ Press SET key for longer than 5 seconds to save the configuration.

③ Description of the pulse cycle .



Note :Periodic timer is operating separated from temperature control.

15. Installation

▶ Install the unit in an environment where

- 1- The temperature in relatively constant
- 2- There is no corrosive gas,
- 3- The humidity is normal, and
- 4- There is no excessive dust and electric noise.



▶ Wire (or line) connections

Sensor line is sensitive to noise from high-voltage power line. Use a separate pipe for sensor wires.

▶ For applications ,capable of having body injury or property damage ,it is advised to use a double safety device.

تغییر این پارامتر با کلید Up یا Dn انجام میگردد. محدوده تغییرات برای سنسور IC, PT100 در محدوده 0.1~19.9°C و برای سنسور K Type، 1~50°C خواهد بود. با کلید SET آنرا ذخیره نمایید و فشار ممتد این کلید شما را به صفحه جاری میرساند.

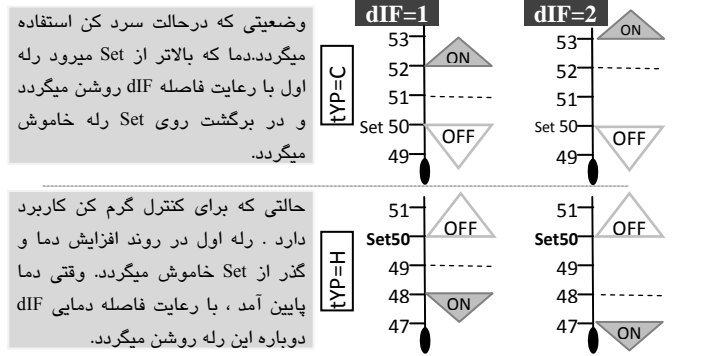

0 تایمر تاخیری عملکرد رله اصلی dLt
در حالتی که حرارت جاری روی صفحه است، کلید SET را برای بیش از 5 ثانیه بفشارید. زمانی که نماد dIF روی ت شد، کلید را رها کنید. با چند بار فشار کلید SET همزمان با نمایش نماد dLt می توانید عدد تایمر مورد نظر را برحسب ثانیه با فشار کلید Up یا Dn انتخاب کنید. با فشار 5 ثانیه ای کلید SET این رقم در حافظه ذخیره میگردد و به صفحه جاری باز میگردد. حین کار کنترلی دستگاه برای وصل مجدد رله کنترل حرارت دو شرط اجرا میگردد. اول رسیدن رطوبت به حد مورد نظر و دوم طی شدن همین زمان dLt (240 تا 0 ثانیه)

1 تنظیم رله دوم بعنوان آلارم دمایی یا تایمری
در حالت خاموش کلید SET را بفشارید و دستگاه را روشن نمایید و کلید را تا دیدن نماد STH نگه دارید. کلید را رها کنید. با چند بار فشار کلید SET به نماد Typ می رسمیم، که برای تعیین نوع کارکرد کنترلی رله دوم است. اگر عمل حرارت دهی را از رله دوم بخواهیم این پارامتر را روی H تنظیم میکنیم. اگر عمل برودت یا کاهش حرارت برای رله دوم مدنظر باشد، این پارامتر را روی C تنظیم نمایید. اگر روی t باشد، حالت تایمری مدنظر میگردد. (معیار دقیقه)

تایمری	تایمر کارکرد On و تایمر تاخیر Off	t
تنظیم حالت	پایین تر رفتن دما از تنظیم = رله روشن	H
آلارمی	بالا تر رفتن دما از تنظیم = مساوی رله روشن	C

برای تغییر این تنظیم باید با کلید Up یا Dn نماد مورد نظر H یا C یا t را تنظیم نمایید و برای ذخیره در حافظه دستگاه کلید SET را بفشارید.

tyP=H	Pro=100	رله دوم پایین تر از 100 درجه روشن میگردد
tyP=C	Pro=100	رله دوم بالاتر از 100 درجه روشن میگردد
tyP=t	On=100	زمان خاموش بودن رله
	Off=100	زمان روشن بودن رله

7 حفاظت و ایمنی LoC
برای جلوگیری از دستکاری افراد غیر مجاز و همچنین محدود کردن محدوده تنظیم SET، در حالتی که کلید SET فشار داده اید، سیستم را روشن نمایید. زمانی که نماد StH را دیدید کلید را رها کنید. با چند بار فشار کلید SET به نماد LoC میرسیم. با یکی از کلید های Up یا Dn آنرا بترتیب زیر تنظیم نمایید.

LoC	تنظیمات کنترلر باز است	0
	کلید تنظیمهای کنترلر قفل است	1

نکته: فشار دکمه UP در حالت اجرا، دمای تنظیم شده را نمایش میدهد.

Model	Sensor Type	Range	Output
SUN-15	T (IC)	-50~125°C	Main and Aux Output Relay 5A
	PT (PT100)	-200~400°C	
	TC (K-TYPE, CA)	-200~1300°C	

- 1 - قابلیت های کلی**
- کنترل هیتری و یا کولری جهت پروسه های گرما ساز یا سرما ساز
 - حساسیت رله کنترل 0.0 تا 19.9 درجه برای مدل IC، Pt و 50~0 برای مدل TC
 - مجهز به رله تایمری صفر تا 999 دقیقه (جهت انواع کاربرد ها همانند دیفراست)
 - امکان حداقل و حداکثر دمای تنظیمی توسط کاربر
 - امکان قفل تنظیمات اصلی برای جلوگیری از دستکاری افراد غیر مجاز

- 2 - تنظیم عملکرد خروجی**
- دستگاه را روشن کنید و منتظر نمایش حرارت جاری در صفحه شوید.
 - کلید SET را یک بار بفشارید، صفحه باید چشمک زن شود.
 - با کلید های UP یا Dn میتوانید ست پوینت جدید را تنظیم نمایید. در صورت فشار ممتد هر یک از کلیدهای فوق بیش از 3 ثانیه، افزایش و یا کاهش اعداد روی صفحه سریعتر اتفاق می افتد و در نهایت محدوده به ارقامی که در تنظیمهای StL و StH آمده، خواهد شد.
 - با فشار کلید SET عدد در حافظه ذخیره میگردد و صفحه نمایش دمای جاری را نمایش میدهد. قبل از تنظیم از نوع کارکرد خود (منطق گرم کن و یا سرد کن) مطمئن شوید.
 - شماره ترمینال های رله اصلی 10 و 9 و 8 است.



- توجه کنید طول سنسور مدل IC حداکثر 30 متر و حتما از سیم شیلد استفاده نمایید.
 - **تصحیح قرائت سنسور** یا خطای احتمالی آن به روش زیر میسر است. در حالی که حرارت جاری را روی صفحه نمایش داریم، کلید SET را 5 ثانیه بفشارید. بعد از نمایش dIF، چند بار کلید SET را بفشارید تا نمایش rSt. حالا توسط کلید Up یا Dn می توانید عدد مورد نظر را برای اضافه کردن و یا کسر نمودن از عدد نمایشی تنظیم کنید. با فشار 5 ثانیه ای کلید SET عدد در حافظه ذخیره میشود. به مثال زیر توجه نمایید:
- | دمای نمایشی | پارامتر تصحیح rSt | نمایش تصحیح شده |
|-------------|-------------------|-----------------|
| 20.0°C | + -5.0°C | = 15.0°C |
| 20.0°C | + 10.0°C | = 30.0°C |

- 4 حساسیت قطع و وصل رله اول (هیستریزس)**
- کنترلر برای تنظیم حرارت، رله اول را قطع و وصل می کند. میتوان فاصله قطع و یا وصل را با عدد ست پوینت تعیین نمود. این فاصله حرارتی همان پارامتر dIF است. برای آن کلید SET را بیش از 5 ثانیه بفشارید و تا رویت نماد dIF نگه دارید.