

User Manual

DGI900



The logo for degdrive, featuring three horizontal grey bars to the left of the word 'degdrive' in a bold, sans-serif font. The 'deg' is in orange and 'drive' is in grey. A registered trademark symbol (®) is located at the end of the word.

Contents

Preface	1
Chapter 1 Safety Precautions	4
1.1 Unpackage Inspection	4
1.2 Safety Information	4
1.3 General Precautions	8
1.4 Disposal	10
Chapter 2 Models and Specifications	11
2.1 Models	11
2.2 Specifications	12
2.3 Parts of Inverter	15
2.4 Dimensions	16
2.5 Optional Parts	19
Chapter 3 Installation and Wire Connection	23
3.1 Installation	23
3.2 Removing and Mounting Front Cover of Inverter	24
3.3 Wire Connection	24
3.4 Main Circuit Wiring	25
3.5 Basic Wiring Diagram	27
3.6 Control Circuit Terminal Wiring	27
3.7 EMC Installation Instruction	35

Chapter 4 Running of Inverter	39
4.1 Running of Inverter	39
4.2 Operation and Using of the Control Panel	42
4.3 Inverter power switch on	49
Chapter 5 Function Code Table	50
Chapter 6 Description of Function Codes	98
6.1 Basic Parameters (Group P0)	98
6.2 Start/Stop Control (Group P1)	106
6.3 Auxiliary Functions (Group P2)	111
6.4 Input Terminals (Group P3)	124
6.5 Output Terminals (Group P4)	139
6.6 V/F Control Parameter (Group P5)	145
6.7 PID Function (Group P6)	150
6.8 Operation Panel and Display (Group P7)	157
6.9 Motor Parameters (Group P8)	160
6.10 Torque Control and Vector Control Parameters (Group P9)	163
6.11 Parameter Protection (Group PA)	168
6.12 Multi-Reference and Simple PLC Function (Group Pb)	177
6.13 Communication Parameter (Group PC)	180
6.14 Function Code Parameter (Group Pd)	180
6.15 Swing Frequency, Fixed Length and Count (Group PE)	181
6.16 AI/AO Correction and AI Curve Setting (Group PF)	184
6.17 User-Defined Function Codes (Group E0)	188
6.18 Motor 2 to Motor 4 Parameters (Group E3、E4、E5)	189
6.19 Standard Monitoring Parameters (Group b0)	189
Chapter 7 Troubleshooting	190
7.1 Fault Alarm and Troubleshooting	190

7.2 Fault Record Search	195
7.3 Fault Reset	195
Chapter 8 Preservation and Maintenance	196
8.1 Preservation and Maintenance	196
8.2 Periodic Preservation and Maintenance	196
8.3 Warranty of Inverter	197
Chapter 9 Serial port RS485 communication protocol	199
9.1 Communication overview	199
9.2 Communication protocol specification	199
9.3 RTU protocol	200

Chapter 1 Safety Precautions

Unpackage Inspection

Upon unpacking, check:

- Whether the nameplate model and AC drive ratings are consistent with your order. The box contains the AC drive, certificate of conformity, user manual and warranty card.
- Whether the AC drive is damaged during transportation. If you find any omission or damage, contact your supplier immediately.

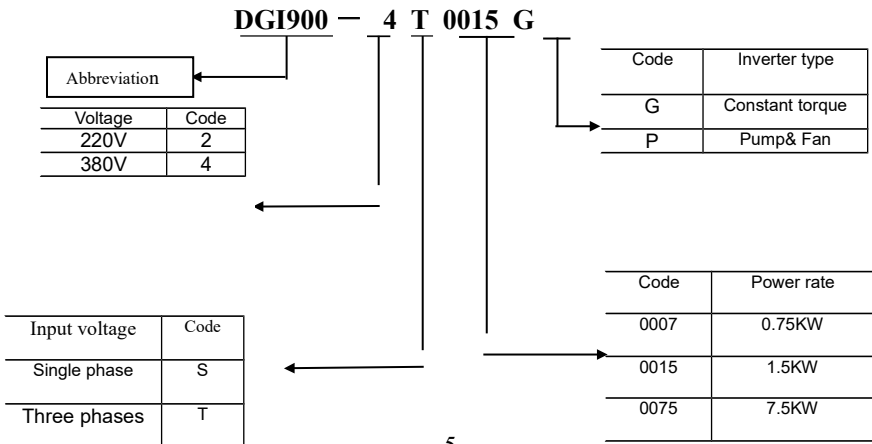









Fig 1-1. Models description





1.2 Safety Information

The use phase	Safety class	Precaution
Before Installation	 Danger	<ul style="list-style-type: none"> ◆ Do not install the product if the package is with water, or component is missing or broken. ◆ Do not install the product if the label on the package is not identical to that on the inverter.
	 Caution	<ul style="list-style-type: none"> ◆ Be careful of carrying or transportation. Risk of devices damage. ◆ Do not use damaged product or the inverters missing component .Risk of injury. ◆ Do not touch the parts of control system with bare hands. Risk of ESD hazard.
Installation	 Danger	<ul style="list-style-type: none"> ◆ Installation base shall be metal or other non-flammable material. Risk of fire. ◆ Do not install inverter in an environment containing explosive gases, otherwise there is danger of explosion. ◆ Do not unscrew the fixing bolts, especially the bolts with red mark.

	 <p>Caution</p>	<ul style="list-style-type: none">◆ Do not leave cable strips or screws in the inverter. Risk of inverter damage.◆ Install the product at the place with less vibration and no direct sunlight.◆ Consider the installation space for cooling purpose when two or more inverters are placed in the same cabinet.
--	--	---

<p>Wiring</p>	<p> Danger</p>	<ul style="list-style-type: none"> ◆ Wiring must be performed by authorized and qualified personnel. Risk of danger. ◆ Circuit-breaker should be installed between inverter and the mains. Risk of fire. ◆ Make sure the input power supply has been completely disconnected before wiring. Failure to comply may result in personnel injury and/or equipment damage. ◆ Since overall leakage current of this equipment may be bigger than 3.5mA, for safety's sake, this equipment and its associated motor must be well grounded so as to avoid risk of electric shock. ◆ Never connect the power cables to the output terminals (U, V, W) of the AC drive. Pay attention to the marks of the wiring terminals and ensure correct wiring. Failure to comply will result in damage to the AC drive. ◆ Install braking resistors at terminals (P+)and (P- or PB) only. Failure to comply may result in equipment damage.
---------------	--	--

	 Caution	<ul style="list-style-type: none"> ◆ Since all adjustable frequency AC drives from our company has been subjected to hi-pot test before delivery, users are prohibited from implementing such a test on this equipment. Failure to comply may result in equipment damage. ◆ Signal wires should to the best of the possibility be away from main power lines. If this cannot be ensured, vertical cross-arrangement shall be implemented, otherwise interference noise to control signal may occur. ◆ If motor cables are longer than 100m, it is recommended output AC reactor be used. Failure to comply may result in faults.
Before Power- on	 Danger	◆ Inverter shall be power-on only after the front cover is assembled. Risk of electrical hazard.
	 Caution	◆ Verify that the input voltage is identical to the rated voltage of product, correct wiring of input terminals R, S, T and output terminals U, V, and W, wiring of inverter and its peripheral circuits, and all wires should be in good connection. Risk of inverter damage.

After Power-on	 Danger	<ul style="list-style-type: none"> ◆ Do not open the cover after power. Risk of electrical hazard. ◆ Do not touches any input/output terminals of inverter with bare hands. Risk of electrical hazard.
	 Caution	<ul style="list-style-type: none"> ◆ If auto tuning is required, be careful of personal injury when motor is running. Risk of accident. ◆ Do not change the defaults of parameters. Risk of devices damage.
During Operation	 Danger	<ul style="list-style-type: none"> ◆ Non-professionals shall not detect signals during operation. Risk of personal injury or device damage. ◆ Do not touch the fan or the discharging resistor to check the temperature. Failure to comply will result in personal burnt.
	 Caution	<ul style="list-style-type: none"> ◆ Prevent any foreign items from being left in the devices during operation. Risk of device damage. ◆ Do not control start/stop of inverter by ON/OFF of contactor. Risk of device damage.
Maintenance	 Danger	<ul style="list-style-type: none"> ◆ Maintenance and inspection can only be performed by professionals. Risk of personal injury. ◆ Maintain and inspect devices after power is off. Risk of electric hazard. ◆ Repair or maintain the AC drive only ten minutes after the AC drive is powered off. This allows for the residual voltage in the

	<p>capacitor to discharge to a safe value.</p> <p>Failure to comply will result in personal injury.</p> <ul style="list-style-type: none"> ◆ All pluggable components can be inserted or pulled out only when power has been turned off. ◆ Set and check the parameters again after the AC drive is replaced.
--	---

General Precautions

1. Constant torque low frequency running

When inverter with induce motor running at long time low speed, the effect of heat emission will get worse and influence motor using life. If low speed constant torque running for long time, user have to use Variable frequency motor.

2. Motor insulation test

Perform the insulation test when the motor is used for the first time, or when it is re-used after being stored for a long time, or in a regular check-up, in order to prevent the poor insulation of motor windings from damaging the AC drive. The motor must be disconnected from the AC drive during the insulation test.

3. Hoist load

In Hoist load application, as the inertia exist, inverter will trip as over current or overvoltage fault. In the case, braking unit and resistor should be connected.

4. Vibration of mechanical device

The AC drive may encounter the mechanical resonance point at some output frequency, which can be avoided by setting the skip frequency.

5. Voltage-sensitive device or capacitor on output side of the AC drive

Do not install the capacitor for improving power factor or lightning protection voltage sensitive resistor on the output side of the AC drive because the output of the AC drive is PWM wave. Otherwise, the AC drive may suffer transient overcurrent or even be damaged.

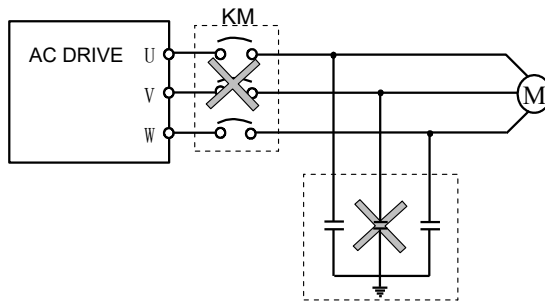

Fig 1-2. Inverter not allowed to connect capacitor

6. Derate at Basic frequency setting

When basic frequency is lower than rated frequency, be caution to derate motor avoiding motor burn.

7. Running at over 50 Hz

If the AC drive is required to run at over 50 Hz, motor vibration and noise will increase. Consider the capacity of the machine.

8. Thermal protection of motor

If the rated capacity of the motor selected does not match that of the AC drive, especially when the AC drive's rated power is greater than the motor's, adjust the motor protection parameters on the operation panel of the AC drive or install a thermal relay in the motor circuit for protection.

9. Altitude and de-rating

In places where the altitude is above 1000 m and the cooling effect reduces due to thin air, it is necessary to de-rate the AC drive.

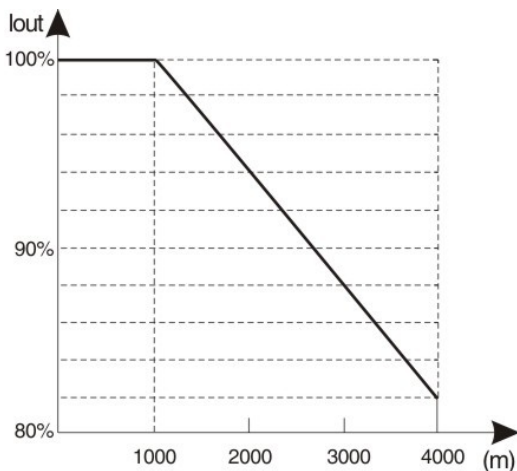

Fig 1-3. Inverter output current derating and Altitude

10. Protection class

DGI900 protection level is IP20 when inverter with keypad.

Disposal

The electrolytic capacitors on the main circuits and PCB may explode when they are burnt. Poisonous gas is generated when the plastic parts are burnt. Treat them as ordinary industrial waste.

Chapter 2 Models and Specifications

2.1 Models

DGI900 series inverter has 2 kinds of voltage levels, 220V and 380V. The Power range is from 0.4KW to 450KW. Models of DGI900 series are shown in Table 2-1.

Table 2-1. Models description

Voltage level	Models		Rated capacity (Rated output	Applicable motor(KW)
220V Single phase	DGI900-2S0004G		1.1	3.0	0.4
	DGI900-2S0007G		1.5	4.7	0.75
	DGI900-2S0015G		2.8	7.5	1.5
	DGI900-2S0022G		3.8	10.0	2.2
220V Three phase	DGI900-2T0015G		3.0	7.0	1.5
	DGI900-2T0022G		4.0	10.0	2.2
380V Three phase	DGI900-4T0007G		1.5	2.5	0.75
	DGI900-4T0015G		2.5	4.0	1.5
	DGI900-4T0022G	DGI900-4T0022P	3.0	6.0	2.2
	DGI900-4T0037G	DGI900-4T0037P	5.9	9.6	3.7
	DGI900-4T0055G	DGI900-4T0055P	8.5	14.0	5.5
	DGI900-4T0075G	DGI900-4T0075P	11	17.0	7.5
	DGI900-4T0110G	DGI900-4T0110P	17	25	11
	DGI900-4T0150G	DGI900-4T0150P	21.7	32	15
	DGI900-4T0185G	DGI900-4T0185P	25.7	39	18.5
	DGI900-4T0220G	DGI900-4T0220P	29.6	45	22
	DGI900-4T0300G	DGI900-4T0300P	39.5	60	30
	DGI900-4T0370G	DGI900-4T0370P	49.4	75	37
DGI900-4T0450G	DGI900-4T0450P	60	91	45	

380V Three phase	DGI900-4T0550G	DGI900-4T0550P	73.7	112	55
	DGI900-4T0750G	DGI900-4T0750P	99	150	75
	DGI900-4T0900G	DGI900-4T0900P	116	176	90
	DGI900-4T1100G	DGI900-4T1100P	138	210	110
	DGI900-4T1320G	DGI900-4T1320P	167	253	132
	DGI900-4T1600G	DGI900-4T1600P	200	304	160
	DGI900-4T1850G	DGI900-4T1850P	234	355	187
	DGI900-4T2000G	DGI900-4T2000P	248	377	200
	DGI900-4T2200G	DGI900-4T2200P	280	426	220
	DGI900-4T2500G	DGI900-4T2500P	318	474	250
	DGI900-4T2800G	DGI900-4T2800P	342	520	280
	DGI900-4T3150G	DGI900-4T3150P	390	600	315
	DGI900-4T3500G	DGI900-4T3500P	435	660	350
	DGI900-4T4000G	DGI900-4T4000P	493	750	400
	DGI900-4T4500G	DGI900-4T4500P	560	850	450

2.2 Specifications

Items		Specifications
Input	Rated Voltage	Single phase 220V, three phase 220V, three phase 380V; 50Hz/60Hz
	Range	Voltage: $\pm 20\%$ voltage unbalance rate: $< 3\%$; frequency: $\pm 5\%$
Output	Rated voltage	0~200V/220V/380V
	Frequency range	0Hz~500Hz
	Frequency resolution	0.01Hz

	Overload ability	150% rated current for 1 minute, 180% rated current for 3 seconds
Control function	Modulation modes	Optimized space voltage vector SVPWM modulation
	Control mode	V/F, Sensor less vector and Closed loop vector control
	Frequency accuracy	Digital setting: The highest frequency $\times \pm 0.01\%$ Analog setting: The highest frequency $\times \pm 0.2\%$
	Frequency resolution	Digital setting: 0.01Hz; Analog setting: The highest frequency $\times 0.1\%$
	Start frequency	0.40Hz~20.00Hz
	Torque boost	Auto torque boost, manual torque boost 0.1%~30.0%
	V/F curve	Five ways: constant torque V/F curve, 1 kind of user defined V/F curve, 3 kinds of down torque curve (2.0/1.7/1.2 times the power)
	Acc./Dec. curve	Two ways: linear Acc./Dec., S-curve Acc./Dec.; 7 kinds of Acc./Dec. time, Time unit (minute/second) optional, max time: 6000 minutes.
	DC braking	DC braking start frequency : 0~15.00Hz braking time : 0~60.0s braking current : 0~80%
	Energy consuming braking	Below 22KW drive built-in energy consuming braking unit, 30-37KW built-in braking unit optional, external braking resistor is optional.

Control function	Jog running	Jog frequency range:0.1Hz~50.00Hz, JOG Acc./Dec. time: 0.1~60.0s
	PI built-in	Easily constitute a close loop control system
	Multi-stage speed running	Multi-stage speed running available through built-in PLC or control terminals
	Textile swing frequency	Swing frequency available with preset and central frequency adjustable
	Auto voltage regulation	Keep a stable voltage automatically when the grid voltage transients
	Auto energy saving running	Saving energy by auto optimizing V/F curve according to the load
	Auto current limiting	Auto current limiting to prevent frequent over current fault trip
	Multi pumps control	With water supply card, the function can implement multi pumps constant pressure water supply
	Communic ation	4 field bus: Modbus, Profibus, CANlink, CANopen

Running function	Running command channel	Control panel : control terminal :serial port :3 channels switchable
	Frequency setting channel	Control panel potentiometer setting: ▲、▼control panel keys setting; Function code setting: Serial port setting; Terminal up/down setting: Input Analog voltage setting: Input Analog current setting: Input pulse setting; Combination ways setting; Above ways are switchable.
	Switch input channel	FWD/REV command: 8channels programmable switch inputs, 35kinds of function can be set separately
	Analog input channel	4~20mA: 0-10V: 2 optional analog inputs
	Analog output channel	4~20mA or 0~10V optional, setting frequency and output frequency ,etc feature output
	Switch/pulse output channel	2 channels Programmable open collectors output, 2 channels relays output, 1 channel 0~20KHz pulse output
	Control panel	LED digital display
External meter display		Display output frequency, output current, output voltage, etc.
Key lock		All the keys can be locked

	Parameter copy	Function code parameters are able to be copied between inverters when use remote control panel.
Protection function		Overcurrentprotection:overvoltageprotection:undervoltageprotection:overheating protection: overload protection, etc.
Optional parts		Braking unit: remote control panel: cable: panel mounting feet, etc.
Environment	Environment	Indoors, free from direct sunlight, dust, corrosive gas, oil mist, steam, water dropper salt, etc
	Altitude	Lower than 1000m (derating is necessary above 1000m)
	Ambient temperature	- 10℃ ~ + 40℃
	Humidity	<95%RH, no condensation
	Vibration	Lower than 5.9m/s (0.6g)
	Storage temperature	- 20℃ ~ + 60℃
Structure	Protection level	IP20 (In the selection of state display unit or the keyboard state)
	Cooling	Forced air cooling
Installation		Wall mounted; Floor mounted

2.3 Parts of Inverter

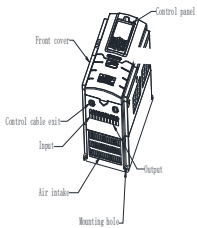

2.4 Dimensions

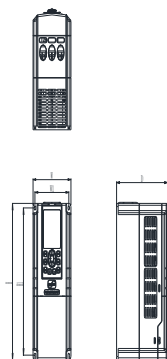

Table 2-2 Dimensions (mm)

Wall mounting

Inverter Model		W1	W	H1	H	D	Mount
G Type	P Type	(mm)	(mm)	(mm)	(mm)	(mm)	hole
DGI900-2S0004G		74	85	144	142	113	Φ5
DGI900-2S0007G							
DGI900-2S0015G							
DGI900-4T0007G	DGI900-4T0015P	88	98	174	184	135	Φ5
DGI900-4T0015G	DGI900-4T0022P						
DGI900-2S0022G							
DGI900-4T0022G	DGI900-4T0037P	108	118	220	230	153	Φ5
DGI900-4T0037G	DGI900-4T0055P						
DGI900-4T0055G	DGI900-4T0075P	155	172	256	271	183	Φ5
DGI900-4T0075G	DGI900-4T0110P						
DGI900-4T0110G	DGI900-4T0150P	170	248	340	360	210	Φ6
DGI900-4T0150G	DGI900-4T0185P						
DGI900-4T0185G	DGI900-4T0220P	200	280	426	445	210	Φ8
DGI900-4T0220G	DGI900-4T0300P						
DGI900-4T0300G	DGI900-4T0370P	200	320	511	530	235	Φ8
DGI900-4T0370G	DGI900-4T0450P						
DGI900-4T0450G	DGI900-4T0550P	280	380	590	610	270	Φ10
DGI900-4T0550G	DGI900-4T0750P						
DGI900-4T0750G	DGI900-4T0900P	280	400	700	730	300	Φ14
DGI900-4T0900G	DGI900-4T1100P						
DGI900-4T1100G	DGI900-4T1320P	400	510	867	895	330	Φ16
DGI900-4T1320G	DGI900-4T1600P						

Floor mouting

Inverter Model		W(mm)	H(mm)	D(mm)
G Type	P Type			

DGI900-4T1600G	DGI900-4T1850P	600	1440	399
DGI900-4T1850G	DGI900-4T2000P			
DGI900-4T2000G	DGI900-4T2200P			
DGI900-4T2200G	DGI900-4T2500P			
DGI900-4T2500G	DGI900-4T2800P			
DGI900-4T2800G	DGI900-4T3150P	720	1400	440
DGI900-4T3150G	DGI900-4T3500P			
DGI900-4T3500G	DGI900-4T4000P	950	1700	475
DGI900-4T4000G	DGI900-4T4500P			
DGI900-4T4500G	DGI900-4T5000P	950	1900	475
DGI900-4T5000G	DGI900-4T5600P			
DGI900-4T5600G	DGI900-4T6300P			
DGI900-4T6300G	DGI900-4T7100P	1200	2000	600
DGI900-4T7100G				

2.5 Optional Parts :

The following parts are optional. If require, please order

2.5.1 Remote control Keypad

Model: DGI900-YK01 (LED keypad) and DGI900-YK02 (LCD Keypad)

RS 485 communications applied between remote control keypad and inverter which are connected by a 4-core cable via RJ45 network port.

The maximum connection distance is 500M. The inverter supports local keypad and remote

control keypad using at the same time, no priority. Both can control the inverter. Hot plug in for remote control keypad is available.

The following functions are available by using remote control keypad:

(1) Control slave inverter to run, stop, jog run, fault reset, change setting frequency, change function parameters and running direction.

(2) Monitor slave inverter's running frequency, setting frequency, output voltage, output current, bus bar voltage, etc.

2.5.2 Communication cable for remote control panel

Type : DGI900-LAN0020 (2.0m)

Standard options:1m, 2m, 5m, 10m, 20m. Which is more than 20m can be customized for the remote keypad and inverter connection.

2.5.3 Field bus Adaptor

The inverter can be connected into MODBUS field bus net work via adaptor as a slave station in the network.

The function as follow:

(1) Send command to inverter such as start, stop, jog running, etc.

(2) Send speed or frequency signal to inverter.

(3) Read status and actual value from inverter.

(4) Fault reset for the inverter.

Please refer to Chapter 9 for communication protocol

2.5.4 Braking Resistors

DGI900 series inverters under 22KW have built-in braking units. If energy consuming braking is needed, please choose braking resistors according to Table 2-3. The wire connection of braking resistors is shown in Fig. 2-3.

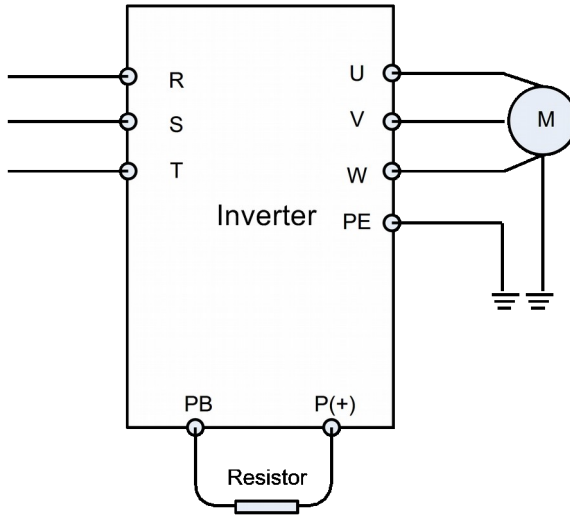

Fig.2-2 The wire connection of braking resistors

Table 2-3 Braking resistors selection table

Model	Applicable motor (KW)	Resistance (Ω)	Resistance power (W)	Braking unite
DGI900-2S0004G	0.4	200	100	Built in
DGI900-2S0007G	0.75	150	200	Built in
DGI900-2S0015G	1.5	100	400	Built in

Model	Applicable motor (KW)	Resistance (Ω)	Resistance power (W)	Braking unite
DGI900-2S0022G	2.2	75	500	Built in
DGI900-4T0007G	0.75	300	400	Built in
DGI900-4T0015G	1.5	300	400	Built in
DGI900-4T0022G	2.2	200	500	Built in
DGI900-4T0037G	4.0	200	500	Built in
DGI900-4T0055G	5.5	100	800	Built in
DGI900-4T0075G	7.5	75	800	Built in
DGI900-4T0110G	11	50	1000	Built in
DGI900-4T0150G	15	40	1500	Built in
DGI900-4T0185G	18.5	30	4000	Built in
DGI900-4T0220G	22	30	4000	Built in
DGI900-4T0300G	30	20	6000	Built in or External
DGI900-4T0370G	37	16	9000	Built in or External
DGI900-4T0450G	45	13.6	9000	External
DGI900-4T0550G	55	20*2	12000	External
DGI900-4T0750G	75	13.6*2	18000	External
DGI900-4T0900G	90	20*3	18000	External
DGI900-4T1100G	110	20*3	18000	External
DGI900-4T1320G	132	20*4	24000	External
DGI900-4T1600G	160	13.6*4	36000	External
DGI900-4T1850G	185	13.6*4	36000	External
DGI900-4T2000G	200	13.6*5	45000	External

Model	Applicable motor (KW)	Resistance (Ω)	Resistance power (W)	Braking unite
DGI900-4T2200G	220	13.6*5	45000	External
DGI900-4T2500G	250	13.6*5	45000	External
DGI900-4T2800G	280	13.6*6	54000	External
DGI900-4T3150G	315	13.6*6	54000	External
DGI900-4T3500G	350	13.6*7	63000	External
DGI900-4T4000G	400	13.6*8	72000	External
DGI900-4T4500G	450	13.6*8	90000	External

Chapter 3 Installation and Wire Connection

3.1 Installation

3.1.1 Environment Requirements

- (1) Please mount inside a well-ventilated location. The ambient temperature is required to be within the range of -10 ~40°C. If the temperature is higher than 40 °C, the inverter should be derated, at the same time the ventilation and heat dissipation should be enhanced.
- (2) Be away from the location full of dust or metal powder, and mount in the location free of direct sunlight.
- (3) Mount in the location free of corrosive gas or combustible gas.
- (4) Humidity should be lower than 90% with no dew condensation.
- (5) Mount in the location where vibration is less than 5.9m/s^2 (0.6G) .
- (6) Please try to keep the inverter away from EMI source and other electronic devices which are sensitive to EMI.

3.1.2 Mounting Space and Direction

- (1) Generally in vertical way.
- (2) For the requirements on mounting space and distance, refer to Fig.3-1.
- (3) When several inverters are installed in one cabinet, they should be mounted in parallel with special incoming and out coming ventilation and special fans. When two inverters are mounted up and down, an air flow diverting plate should be fixed as shown in Fig.3-2 to ensure good heat dissipation.

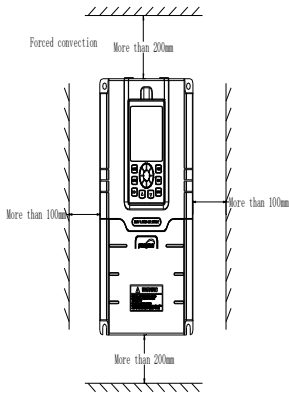

Fig.3-1 Mounting space and distance

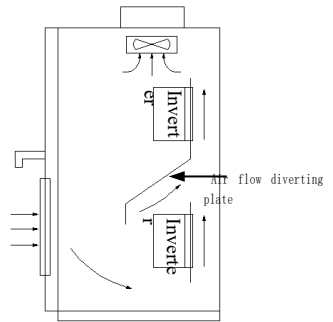

Fig.3-2 Mounting of multiple inverters

3.2 Removing and Mounting Front Cover of Inverter

Removing: Remove 4screws on the cover and take the cover out.

Mounting: Align the mounting holes and screw them.

3.3 Wire Connection

Attention



- (1) Before wiring, please ensure the power has been removed and be wait for at least 10minutes.
- (2) Please do not connect AC power to output terminals U/V/W.
- (3) To ensure the safety, the inverter and motor should be safety grounding. It is necessary to use copper wire above 3.5mmas ground wire, grounding resistance less than 10Ω.
- (4) The inverter has gone through voltage withstand test in factory, please do not

make it again.

- (5) Solenoid switch or absorbing devices, such as ICEL, is prohibited to connect inverter output.
- (6) To provide input over current protection and for convenience in maintenance, the inverter should be connected to AC power through circuit breaker.
- (7) Please use twisted wire or shielded wire above 0.75mm for the wiring of relay input/output loop(X1~X6, FWD, REV, OC, DO).One end of shielding layer suspended, and the other side connected to PE grounding terminal of inverter, wiring length less than 50m .

Danger



- (1) The cover can be removed only when the power is switched off, all the LEDs on the panel are off and waiting at least for 10 minutes.
- (2) Wiring work can be performed only when the DC voltage between P+ and P- terminals is lower than 36V.
- (3) Wiring work can only be done by trained or professional personnel.
- (4) Before usage, check whether the mains voltage meets the requirement of inverter input voltage.

3.4 Main Circuit Wiring

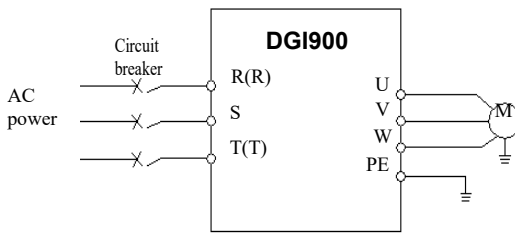



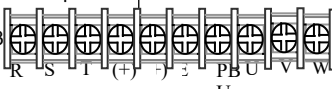

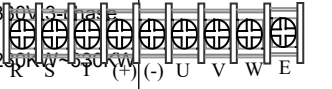

Fig. 3-3 Main circuit wiring

3.4.1 Main Circuit Wiring

Main Circuit input/output terminals, shown as Table 3-1

Table 3-1 Description of Main Circuit input/output terminals

Apply to	Main circuit terminal	Terminal name	Function
220V 1-phase 0		L1, L2	220V 1-phase Input terminals
		U, V, W	3-phase Output terminals'
		E	Earthing
380V 3-phase 0		R, S, T	380V 3-phase Input terminals
		U, V, W	380V 3-phase Output terminals
		P+, PB	Braking resistor wiring terminals
380V 3-phase 3 2: (+) (-) PB R S T E U V W		R, S, T	380V 3-phase Input terminals
		U, V, W	380V 3-phase Output terminals
		P+, PB	Braking resistor wiring terminals
380V 3-phase 3		R, S, T	380V 3-phase Input terminals
		U, V, W	380V 3-phase Output terminals
		P+, PB	Braking resistor wiring terminals
380V 3-phase 4		R, S, T	380V 3-phase Input terminals
		U, V, W	380V 3-phase Output terminals
		P+, PB	Braking resistor wiring terminals
380V 3-phase 240V 1-phase 240V 1-phase 50kW 50kW		R, S, T	380V 3-phase Input terminals
		U, V, W	380V 3-phase Output terminals
		(+), (-)	Braking resistor wiring terminals

3.5 Basic Wiring Diagram

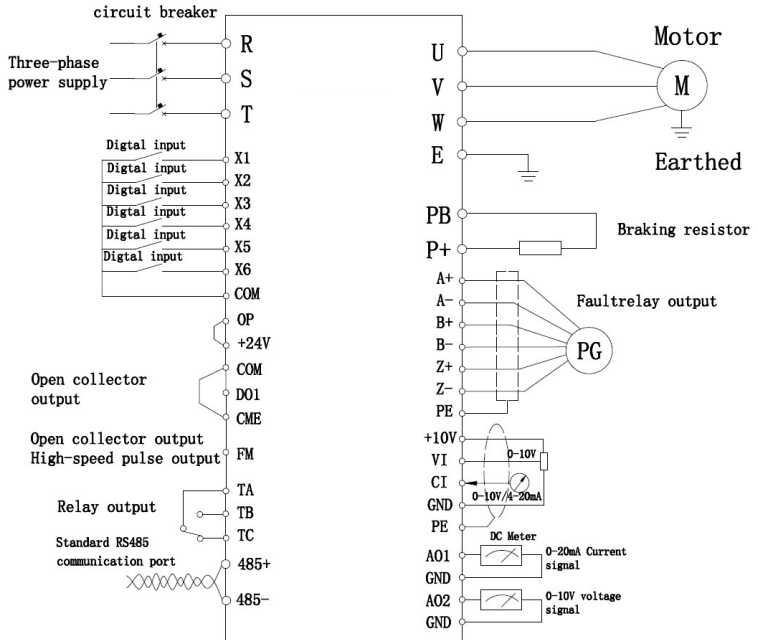

Fig. 3-5 Basic Wiring Diagram

3.6 Control Circuit Terminal Wiring

3.6.1 Position and Function of Terminals and Jumpers on Control Circuit

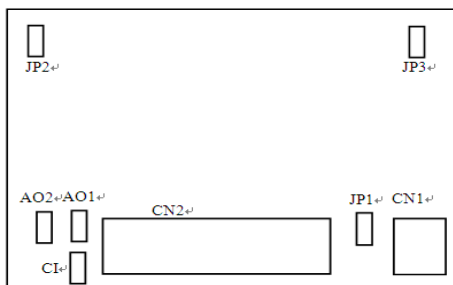

Fig. 3-6 Position of terminals and jumpers on control circuit

Before using the inverter, Please make correct terminals wiring and jumpers setting. It is suggested to use above 1mm² wire as terminal connection wire.

Table 3-2 Jumper switch function

NO	Function Setting	Setting	FD
JP1	COM and CME connecting selection	1-2 connection: COM and CME connected 2-3 connection: COM and CME disconnected	COM and CME connection
JP2	GND and Earthing connecting selection	1 – 2 connection : GND and E (Earthing) disconnected 2 – 3 connection : GND and E (Earthing) connected	1-2
JP3	COM and Earthing connecting selection	1 – 2 connection : COM and E (Earthing) disconnected 2 – 3 connection : COM and E (Earthing) connected	2-3

AO1	AO1 terminal current/ voltage selection	Current selection : AO2: 0~20mA or 4~20mA output Voltage selection : AO2: 0~10V output	0-10V
AO2	AO2 terminal current/ voltage selection	Current selection : AO2: 0~20mA or 4~20mA output Voltage selection : AO2: 0~10V output	0-10V
CI	CI terminal current/ voltage input selection	Current selection : CI: 0~20mA or 4~20mA input Voltage selection : CI: 0~10V input	0-10V

3.6.2 Description of Terminals on Control Circuit

(1) Function of CN 1 terminal shown as Table 3-3

Table 3-3 CN 1 terminal function

Sort	Terminal	Name	Function Description	Specification
Relay output terminal	TA/RA	Multi functional terminal	Can be defined as multifunctional Relay output terminal by programming, refer to Chapter 6.5 P4.02, P4.03	TA-TC: NC, TA-TB: Normal open contact capacity AC250V/2A (COSΦ=1) AC250V/1A (COSΦ=0.4) DC30V/1A
	TB/RB			
	TC/RC			

(2) Control Circuit CN2 terminal shown as Fig.3-7

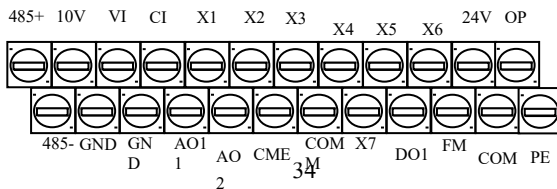

Fig.3-7 CN2 terminal order

(3) Function of CN 2 terminal shown as T able 3-4

Table 3-4 CN 2 terminal function

Sort	Terminal	Name	Function	Specification
Communication	485+	RS485 interface	RS485 differential signal positive terminal	Twisted or shielded wire needed
	485-		RS485 differential signal negative terminal	
Digital output	DO1-CME	Open collector output	Optical coupling isolation, dual polarity open collector output Note: CME and COM are internally insulated, but they are shorted by jumper JP1 on control board. DO1 is driven by +24 V by default. If you want to drive DO1 by external power supply, remove the JP1	Couple output Output voltage range: 0–24 V Output current range: 0–50 mA Refer to P4.0 2

Pulse output	FM-COM	High speed pulse output collector	The programmable multi function terminal defined by P4.06 (FM input mode selection), As open-collector output, its specification is the same as that of DO1. (Common terminal : COM)	Output range defined by P4.09, Max 100KHz
Analog Input	VI	Analog input VI	Analog voltage input (Common terminal : GND)	Input voltage range : 0~10V (Impedance : 47KΩ) Resolution : 1/1000
	CI	Analog input CI	Analog voltage/ current input, voltage/ current selected by Jumper CI, voltage input as default (Common terminal : GND)	Input voltage range : 0~10V (Impedance : 47KΩ) Input current range : 0~20mA (Impedance : : 500Ω) Resolution : 1/1000
Analog output	AO1	Analog output AO1	Analog voltage/ current output, voltage/ current selected by Jumper AO1, voltage output as default. (Common terminal : GND)	Current output range : 4~20mA Voltage output range : 0~10V

	AO2	Analog output AO2	Analog voltage/ current output, voltage/ current selected by Jumper AO2, voltage output as default. (Common terminal : GND).	Current output range : 4~20mA Voltage output range : 0~10V
	X1	Multifunctional input terminal 1	Can be defined as multifunctional on-off input terminal by programming, refer to Chapter 6.5 (P3 group) . (Common terminal: COM) X5, besides features of X11~X16, it can be used for high-speed pulse input. Maximum input frequency: 100 kHz	Optical coupling isolation, compatible dual polarity input Input impedance: R=2 KΩ Max input frequency: 200Hz Input voltage range: 9~30V
	X2	Multifunctional input terminal 2		
	X3	Multifunctional input terminal 3		
	X4	Multifunctional input terminal 4		
	X5	Multifunctional input terminal 5		
	X6	Multifunctional input terminal 6		
Power	P24	+24V common terminal	Supply +24V power (negative terminal: COM)	
	OP	External power supply	Default external power +24V When using external power supply for terminal X1~X6, OP have to connect to external power. And remove the Jumper of OP and +24V terminal	

10V	+10V power	Supply+10Vpower(negative terminal: GND)	Max. output current: 50mA
GND	+10V common terminal	Grounding of analog signal and+10V power source	Terminal COM and GND are Isolated inside
COM	+24Vcommon terminal	Digital signal input, output common terminal	

3.6.3 Analog Input/Output Terminal Wiring

(1) Analog voltage signal input through VI terminal as follow wiring :

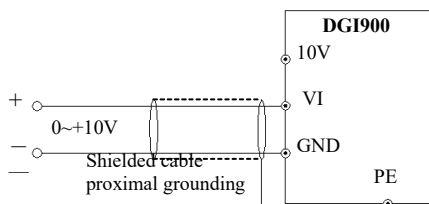

Fig. 3-7 VI terminal wiring

(2) Analog signal input through CI terminal, jumper selection for input voltage (0~10V) or input current (4~20mA) as follow wiring

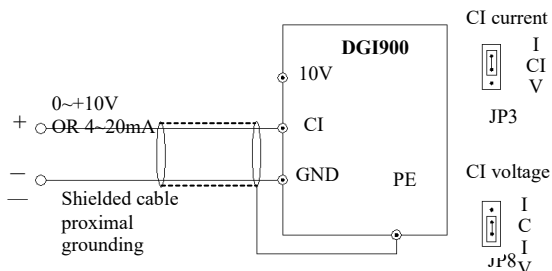

Fig. 3-8 CI terminal wiring

(3) Analog output terminal AO1 wiring

Analog output terminal can be connected with external analog meter indicating various physical quantity, jumper selection for output voltage (0~10V) or output current (4~20mA) as follow wiring.

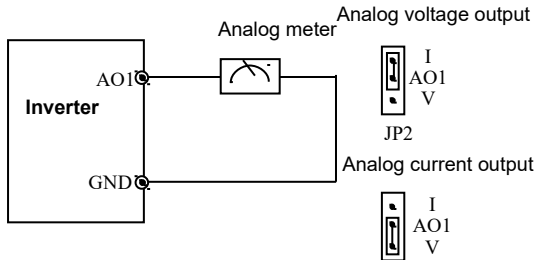
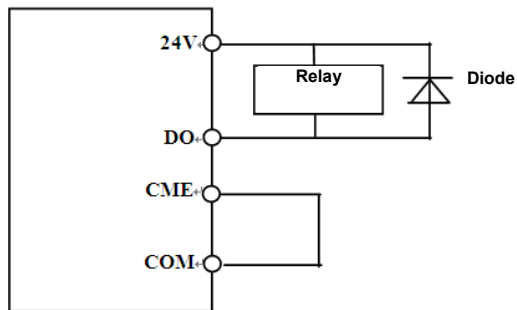

Fig. 3-9 Analog output terminal wiring

(4) Digital output terminal DO wiring

When DO connect to relay, the replay have to connect with diode. Otherwise terminal 24Vpower source may damage. The current should be less than 50mA

Note : The connection of Diode pole should be correct, otherwise terminal 24V power source will damage.



Notes:

(1) Filter capacitor or common-mode inductor can be installed between VI and GND terminal or CI and GND terminal when using analog input mode.

(2) Please use shielded cable and do well grounding, keep the wire as short as possible in order to prevent external interference when using analog input/output mode.

3.6.4 Communication Terminal Wiring

The inverter supplies standard RS 485 communication port

It can constitute one master one slave control system or a one master multi slaves system. The upper computer(PC/PLC)can real time monitor the inverter in the control system and achieve complicated control function such as remote control and spermatic, etc

(1) Remote control panel can be connected with inverter viaRS485port by plugging in the remote control panel into RS485 port without any parameter setting. The local control panel of inverter and remote control panel can work at the same time.

(2) Inverter RS 485 port and upper computer wiring as follow :

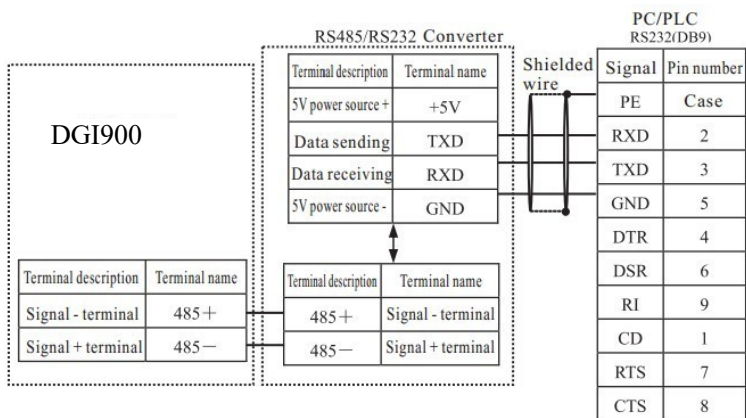

Fig. 3-10 RS485-(RS485/232)-RS232 communication wiring

(3) Multi inverters can communicate via RS485, controlled by PC/PLC as a Master shown as Fig.3-12. It also can be controlled by one of inverters as a Master shown as Fig.3-13

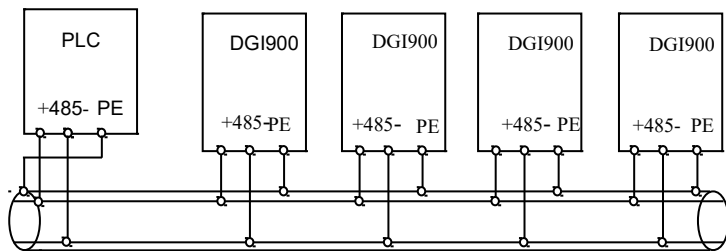

Fig. 3-12 PLC communication with multi inverters

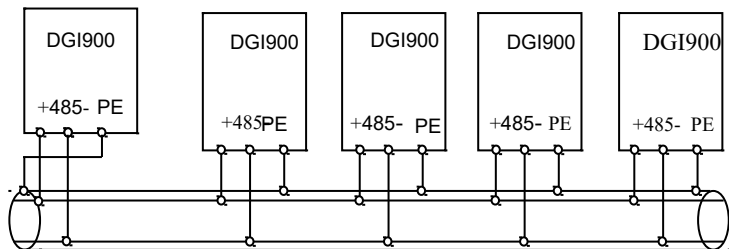

Fig. 3-13 Multi inverters communication

The more inverters connected, the more the communication interference may occur. Please make wiring as above and do well grounding for inverters and motors, or adopt the following measures to prevent interference as even above wiring can't work.

- (1) Separately power supply to PC/PLC or isolated the power of PC/PLC.
- (2) Use EMIFIL to the wire or reduce carrier frequency properly

3.7 EMC Installation Instruction

Inverter outputs PWM wave, it will produce electromagnetic noise. To reduce the interference, EMC installation will be introduced in this section from noise suppression, wire connection, grounding, leakage current and filter of power supply

3.7.1 Noise Suppression

(1) Noise Type

Noise is unavoidable during inverter operation. Its influence over peripheral equipment is related to the noise type, transmission means, as well as the design, install action, wiring and grounding of the driving system

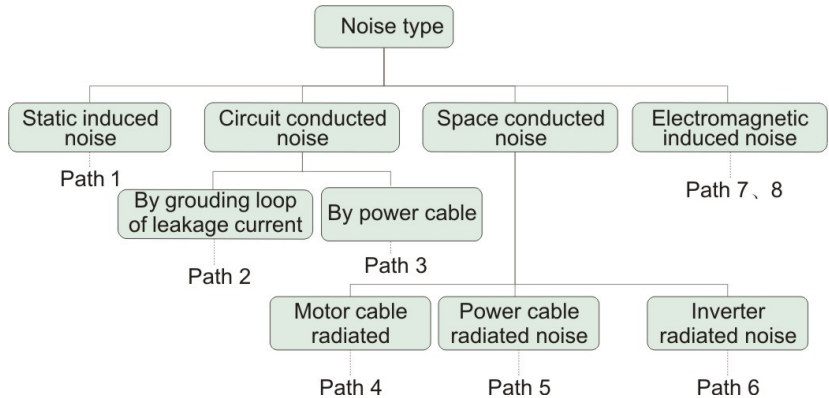

(2) Noise Suppression Methods

Path	Noise suppression methods
□	If a closed loop is formed between the peripheral equipment and the inverter wiring, the grounding leakage of the inverter will misoperate the equipment. Solution: Remove the grounding of the peripheral equipment.
□	When peripheral equipment share the same power source with the inverter, the noise transmitted through the power line may misoperate the peripheral equipment. Solution: Mount a noise filter at inverter input side or isolated the peripheral equipment with an isolated transformer or power filter.

□□□	<p>Electronic equipment such as computers, measuring meters, sensors and radio equipment, when in the same cabinet with inverter, with their wiring close to the inverter, may misoperate due to radio interference.</p> <p>Solution: (1) The susceptible equipment and its signal lines should be kept away from the inverter. Use shielded cable for the signal line. Ground the shielding coat. Protect the signal cable with a metal pipe and keep it off the inverter input/output cable. When crossing of the signal line and the inverter input/output cables is inevitable, make sure it is orthogonal. (2) Mount radio noise filter or linear noise filter (choke coil) to the input/output side of the inverter to suppress the radio noise.</p>
-----	--

Table2-5 Noise suppression method

3.7.2 Wiring Connection and Grounding

(1) Please do not to wire motor cable (from inverter to motor) in parallel with power cable and keep at least 30cm from each other .



Power cable/Motor cable
Fig. 3-16 orthogonal wiring

(2) Please try to arrange the motor cable through Control signal cable metal pipe or in metal wiring groove.

(3) Please use shielded cables control signal cable, and connect the shielding coat to PE terminal of inverter with proximal grounding to inverter.

(4) PE grounding cable should be directly connected to the earth plate.

(5) The control signal cable shouldn't be in parallel with strong electricity cable(power

cable/motor cable).They should not be bent together and should be kept away as least 20cm from each other. If cable crossing is inevitable, please make sure it is same as Fig.3-1

6

(6) Please ground the control signal cable separately with power cable/motor cable.

(7) Please don't connect other devices to inverter power input terminals(R/S/T).



Chapter 4 Running of Inverter

4.1 Running of Inverter

4.1.1 Running Command Channels

There are three channels for inverter receiving commands like START,STOP, JOG and others.

Control panel

Use    panel to control the inverter.(Factory default)

Control terminal

Use one of terminals amongX1~X7 and COM to constitute a 2-wire control mode.

Serial port

Use upper computer (PC/PLC) or Master inverter to control Slave inverter to start or stop via serial port.

The command channels can be selected by setting Function Code P0.03, or by multifunctional input terminal (function code P3.00-P3.09).

Note: These three channels are all switchable. Please make debugging before switch so as to avoid equipment damage and personal injury.

4.1.2 Frequency setting channel

There are 8 kinds of frequency setting channels as follow:

0: by control panel   memory after power off

1: by control panel   h memory after power off

2: analog setting via VI terminal

3: analog setting via CI terminal

4: Pulse terminal setting (PULSE)

5: combination setting

6: Simple PLC function

7: PID setting

8: serial port setting (remote control)

4.1.3 Inverter Running States

When inverter power on, there are two states which are Standby and running state.

Standby state: When power switch on, inverter will be in standby state before receiving control command. Or receiving Stop command during inverter running, inverter will stop and standby.

Running state: After running control command is received, the inverter enters running state

The Running Modes of Inverter

There are five running modes according to priority which are JOG running, close loop running, PLC running, multi-stage speed running and normal running as shown in Fig.4-1.

0 : JOG running

In stopping state, after receiving JOG running command, the inverter will run according to



JOG frequency, for example, by pressing control panel key to give JOG command(refer to function codeP2.00~P3.02).

1 : Close loop running

By setting close loop running control parameter enabled (P0.01=8),the inverter will enter close loop running, that is PI regulation (refer to function code P6). To make close loop running invalid, please set multifunctional input terminal (function22)and switch to lower priority running mode.

2 : PLC running

By setting PLC function parameter enabled (P0.01 =7), the inverter will enter PLC running mode and run according to preset running mode (refer to function code PB).

3 : Multi-stage speed running

By setting non-zero combination of multifunctional input terminal (function12,13,14, 15) and selecting multi-frequency 1-15, the inverter will enter multi-stage speed running mode(refer to function code PB.00~PB.15).

4 : Normal running

Open loop running mode of inverter.

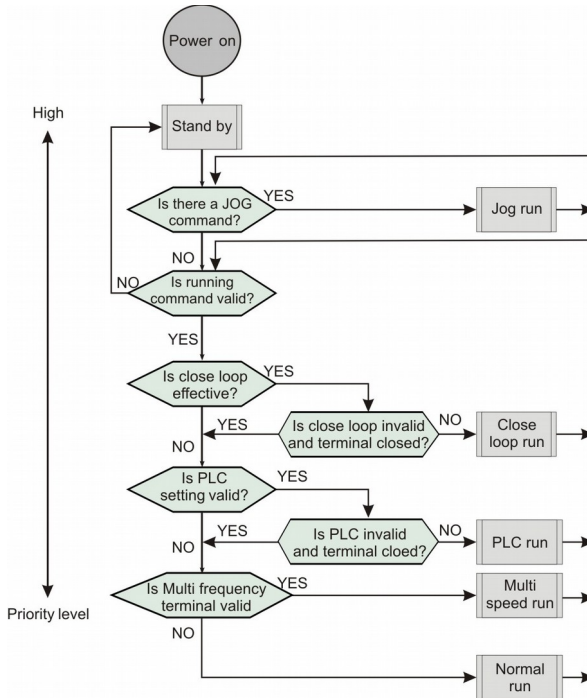

Fig.4-1 Running mode logic diagram Normal run

The above 5 kinds of running modes can be running in multiple frequency setting channel except JOG running. PLC running, multi-stage speed running and normal running can carry out swing frequency running

4.2 Operation and Using of the Control Panel

4.2.1 Control Panel Layout

User can control inverters' start, frequency adjust, stop, braking, setup the running parameters and control peripheral equipment through control panel and control terminal

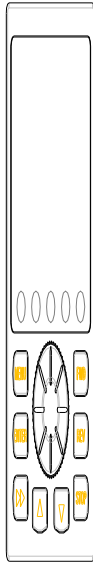











Fig. 4-2 Control panel diagram

4.2.2 Control Panel Function

There are 8 keys and 1 analog potentiometer on the inverter's panel.

The function are shown as follow :

Key	Name	Function Description
FWD	Run	In keypad mode, pressing the key, inverter will run

	Multifunction	REV key is defined as Reverse function. It is also self-defined key which can be set by Parameter
	Stop/Reset	Inverter in running status, pressing the key will stop inverter when command given by keypad. In fault status, pressing the key can reset
	Function/Data	Enter or exit programming status
	UP	Data or function code increment
	DOWN	Data or function code decrement
	Shift/Monitor	In programming, the key can shift code digit. In other status, the key can shift monitoring parameter
	Reserve/switch	In programming, the key can enter next step manual or reserve the setting.
	Digital potentiometers	Left rotary, the same function as UP key. Right rotary, the same function as DOWN KEY Pressing potentiometer, the same function as 

4.2.3 LED Display and Indicator Description

There are a 4 digits LED display, 3 unit indicators and 3 state indicators. These 3 unit indicators have 6 kinds of combinations corresponding to 6 kinds of unit indicating as Fig.4-

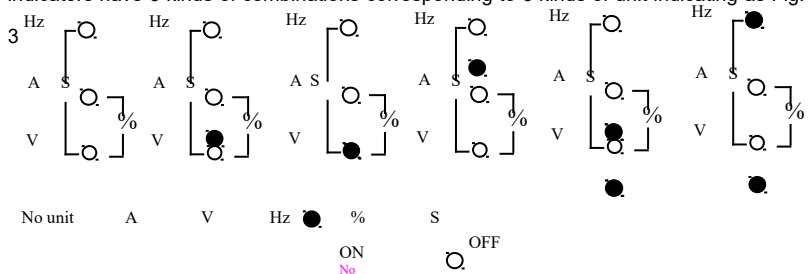

Fig. 4-3 Indicator state and unit indicating

Table 4-2 State indicator description



Item		Function Description		
Display function indicator	LED digital State indicator	FWD	When the motor is running forward, this indicator is on.	When the inverter is in DC braking state, the FWD and REV indicator are on at the same time.
		REV	When the motor is running reverse, this indicator is on.	
		ALM	When there is a fault alarm, this indicator is on	

4.2.4 Control Panel Display State

The control panel display state includes parameter displaying in stopping state, function code parameter displaying in programming state, fault displaying in alarm state, and parameter displaying in running state.

A. Parameter displaying in stopping state

When inverter is in stopping state, panel displays stopping state monitoring parameter which usually is setting frequency (b-01 monitoring parameter) shown as Fig.4-4 B.

Press  to display the other monitoring parameter (The inverter default displays the first 7 monitoring parameters of b group. The other parameters can be defined by function code P3.41 and P3.42. Please refer to Chapter 5). Press  switching to default display parameter b-01, which is setting frequency, or it will display the last monitoring parameter.

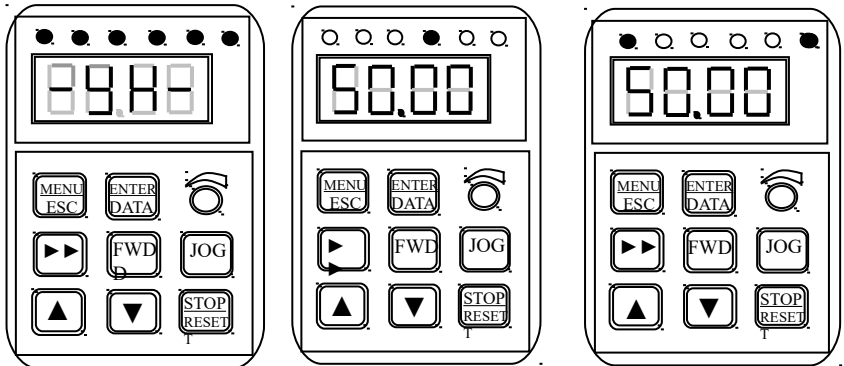

Fig A Initializing
after power on



Fig B Display and flashing
in stopping state

Fig C Display without flashing
in running state

Fig.4-4 Parameter display in initialization, stopping and running state.



B、Parameter displaying in running state

The inverter enters running state after receiving valid running command, and the panel displays running state monitoring parameter. The default displaying is output frequency (b-00 monitoring parameter) shown as Fig.4-4 C.

Press  key can display the monitoring parameter in running state (defined by function code P3.41 and 3.42). While parameter displaying, press  key for switching to default display parameter b-00, that is output frequency, or it will display the last monitoring parameter.

C、Fault displaying in alarm state

The Inverter enters fault alarm display state after fault signal detected. The displayed fault code will be flashing.

Press  key to check fault related parameter. When checking fault related parameter, press  for switching to Fault code display.

Press  to enter programming state to check P6 group parameter of fault information

After troubleshooting, press  key to reset

the inverter (or via control terminal or serial port)

If the fault still exists, it will keep displaying the fault code.

Note:

To some serious fault such as IGBT protection, over current, over voltage, etc. Don't reset the

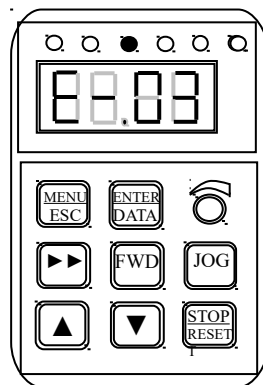

inverter before clearing the fault for sure, otherwise there is a danger of damage.

Fig. 4-5 Fault alarm display state

D、 Function code programming state

In the state of stopping, running, and fault alarm, press **MENU/ESC** to enter programming state (A password is required, If it has been set. Please refer to P0.00 description and Fig.4-10). The programming state includes three level display menus shown as Fig.4-6 which in order are function code group function code number function code parameter. Press key to enter each **ENTER/DAT**. When in function code parameter display menu, press key to save parameter, press **ENTER/DAT**. When in function code parameter display menu, press key to save parameter, press **ENTER/DAT** to go back to previous menu **MENU/ESC** but parameter saving.

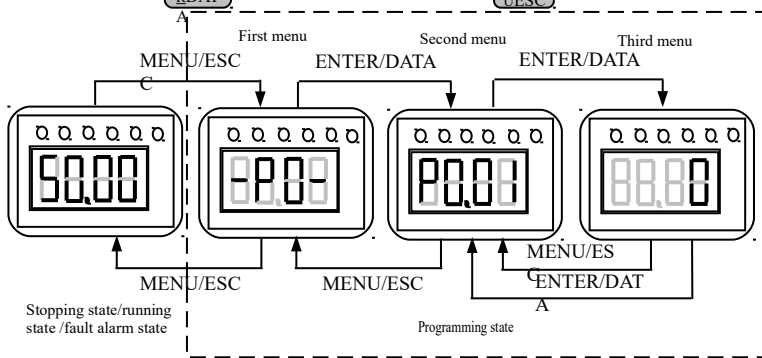

Fig. 4-6 Control panel programming state

4.2.5 Control Panel Operation

Through the operating panel of inverter for various operations, for example as follows:

A、 Switching display of state monitoring parameter

Press **▶▶** to display b group state monitoring parameter. It first displays the code of monitoring parameter, after 1 second, it switches automatically to display the value of this monitoring parameter shown as Fig.4-7.

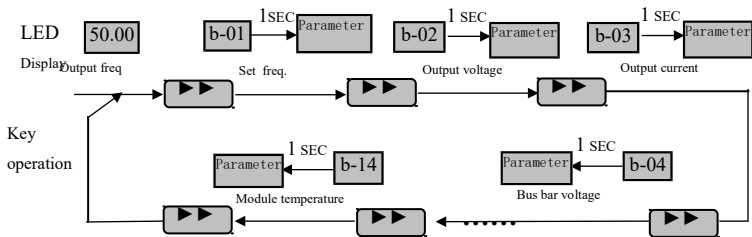

Fig. 4-7 Operation to display monitoring parameter

(2) When viewing monitoring parameter, press **ENTER DATA** for switching to default monitoring parameter display state. Default monitoring parameter is setting frequency in stopping state. In running state, the default monitoring parameter is output frequency.

B、Function code parameter setting

For example, to set parameter code P3.06 from 5.00Hz to 8.50Hz.

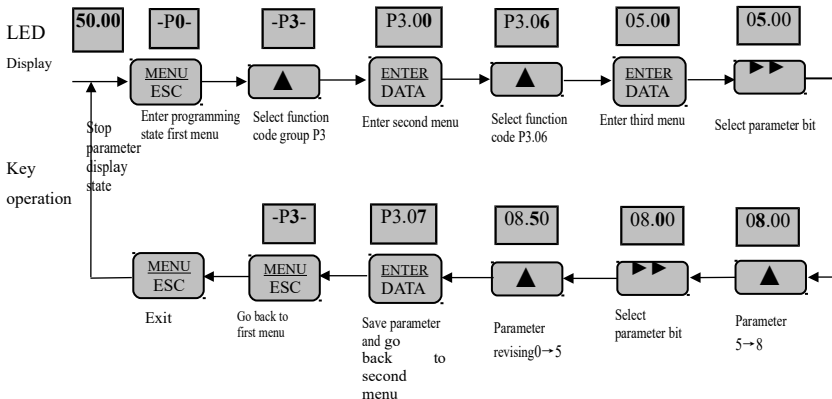

Fig. 4-8 Example of function code parameter setting

Note: In third level menu, if the parameter displayed is not in flashing, it means that this function code is unable to be revised. Probably the reasons are:

- (1) This function code parameter is unmodifiable, such as actual detected state parameter, record running parameter, etc.
- (2) This function code parameter can not be revised in running state. It just can be revised in stopping state.
- (3) The parameter is under protection. When function code P3.01 unit's place is 1 or 2, all function code parameter can not be revised. This is parameter protection to avoid fault operation. Set P3.01 unit's place as 0 to make modification available.

C、JOG running operation

Following is an example. Suppose it is in panel control mode and in stopping state, JOG running frequency is 5Hz.

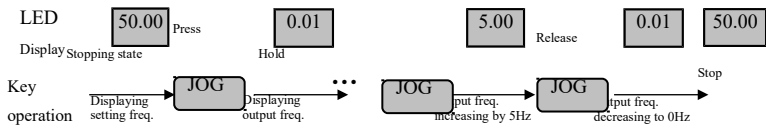
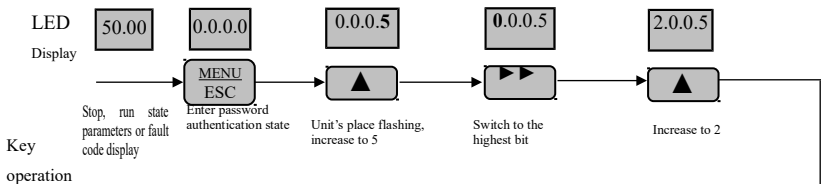

Fig.4-9 JOG running operation

D、Password authentication operation

Suppose P0.00 password parameter has been set as "2345". The authentication operation is shown as Fig. 4-10. The bold figure represents the flashing bit.



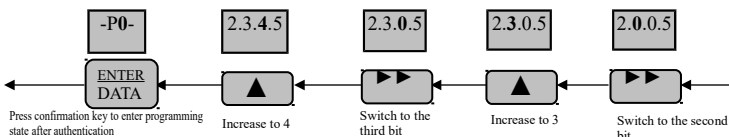

Fig. 4-10 Example of password authentication operation

E、Inquiring fault related parameter:

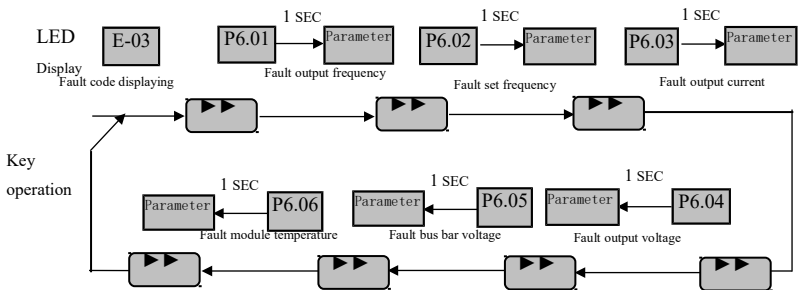

Fig. 4-11 Example of inquiring fault related parameter

Note:

- (1) In fault code display state, press to inquire P6 group function code parameter. The range is from P6.01 to P6.06. After pressing , LED first displays function code, and 1 second later it displays automatically the value of this function code parameter.
- (2) When inquiring fault parameter, press to switch back to fault code display state.



SHIPT

F、Frequency setting operation by control panel , keys

Suppose it is in stopping state and P0.01=1, the operation is as follow.

- (1) Frequency integral adjustment.
- (2) As press , and hold it, LED begins to increase from unit's digit to ten's digit, and then to hundred's digit. If release and then press again, LED will

increase from unit's digit again.

- (3) As press  and hold it, LED begins to decrease from unit's digit to ten's digit , and then to hundred's digit. If release  and then press  again, LED will decrease from unit's digit again.

G、 Control panel key lock operation:

Press  for 5 seconds to lock control panel key. It displays 'LOCC', as panel locked.

H、 Control panel key unlock operation:

Press  for 5 seconds to unlock control panel key.

4.3 Inverter power switch on

4.3.1 Inspection Before Power on

Please perform cable connection according to the requirements in manual.

4.3.2 Initial Power on Operation

After inspecting cable connection and power source for sure, switch on inverter input AC power switch. The inverter's LED on control panel will display dynamic start menu. When it displays set frequency, it means initialization has been completed. :

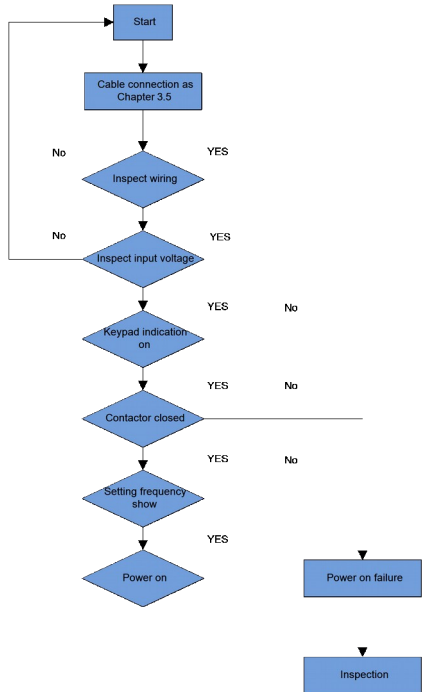

Fig. 4-12 Inverter first power applied operation process

Chapter 5 Function Code Table

5.1 The symbols in the function code table are described as follows

“○”: The parameter can be modified when the AC drive is in either stop or running state.

“×”: The parameter can not be modified when the AC drive is in the running state.

“* ”: The parameter is factory parameter and can not be modified.

5.2 Standard Function Parameters

Group P0: Standard Function Parameter					
Function Code	Parameter Name	Setting Range	Minimum Unit	Default	Property
P0.00	Control mode	0 : V/F control 1 : Sensorless vector control(SVC) 2 : Sensor vector control	1	0	×
P0.01	Main frequency source 1 selection	0 : Digital setting 1(P0.02, UP/DOWN can modify,non-retentive at power failure) 1 : Digital setting 2(P0.02, UP/DOWN can modify,retentive at power failure) 2 : VI analog setting (VI-GND) 3: Clanalog setting (CI-	1	0	×

		GND) 5 : Pulse setting 6 : Multi-reference 7 : Simple PLC 8 : PID 9 : 485 communication			
P0.02	Preset frequency	P0.07lower limit frequency ~ P0.06 upper limit frequency	0.01HZ	50.00HZ	○
P0.03	Command source selection	0 : Operation panel control (LED off) 1 : Terminal control (LED on) 2 : Communication control (LED blinking)	1	0	○
P0.04	Rotation direction	0:Same direction 1 : Reverse direction	1	0	○
P0.05	Maximum frequency	50.00Hz~320.00Hz	0.01Hz	50.00Hz	×
P0.06	Frequency upper limit	Frequency lower limit to maximum frequency (P0.05)	0.01Hz	50.00Hz	○
P0.07	Frequency lower limit	0.00Hz to frequency upper limit(P0.06)	0.01Hz	0.00Hz	○
P0.08	Source of frequency upper limit	0 : Set by P0.06 1:VI 2:CI 4:PULSE setting 5 : Communication setting	1	0	×
P0.09	Frequency upper	0.00Hz to maximum	0.01Hz	0.00Hz	○

	limit offset	frequency (P0.05)			
P0.10	Carrier frequency	0.5KHZ~16.0KHZ	0.1KHZ	Model dependent	○
P0.11	Carrier frequency adjustment with temperature	0 : No 1 : Yes	1	0	○
P0.12	Acceleration time 1	0.1~6000.0s	0.1s	Model dependent	○
P0.13	Deceleration time 1	0.1~6000.0s	0.1s	Model dependent	○
P0.14	Acceleration/ Deceleration time unit	0 : 1s 1 : 0.1s 2 : 0.01s	1	1	×
P0.15	Acceleration/ Deceleration time base frequency	0 : Maximum frequency (P0.05) 1: set frequency 2 : 100HZ	1	0	×
P0.16	Auxiliary frequency source 2 selection	The same as P0.01(Main frequency source 1 selection)	1	0	×
P0.17	Range of auxiliary frequency 2 for 1 and 2 operation	0 : Relative to maximum frequency 1 : Relative to main frequency 1	1	0	○
P0.18	Range of auxiliary frequency 2 for 1 and 2 operation	0%-150%		100%	○

P0.19	Frequency source selection	<p>Unit's digit : (Frequency spurce selection)</p> <p>0 : Main frequency source 1</p> <p>1 : 1 and 2 operation (operation relationship determined by ten's digit)</p> <p>2 : Switchover between 1 and 2</p> <p>3 : Switchover between 1 and "1 and 2 operation"</p> <p>4 : Switchover between 2 and "1 and 2 operation"</p> <p>Ten's digit (1 and 2 operation relationship)</p> <p>0 : 1+2</p> <p>1 : 1 - 2</p> <p>2 : Maximum</p> <p>3 : Minimum</p>	01	00	○
P0.20	Frequency offset of auxiliary frequency source for 1 and 2 operation	0.00Hz to maximum frequency (P0.05)	0.01HZ	0.00HZ	○
P0.21	Frequency reference resolution	<p>1 : 0.1Hz</p> <p>2 : 0.01Hz</p>	1	2	×
P0.22	Retentive of digital setting frequency upon power failure	<p>0: Not retentive</p> <p>1 : Retentive</p>	1	0	○

P0.23	Base frequency for UP/DOWN modification during running	<p>0: Running frequency</p> <p>1 : Set frequency</p>	0	0	×
P0.24	Binding command source to frequency source	<p>Unit's digit (binding operation panel command to frequency source)</p> <p>0 : No binding</p> <p>1: Frequency source by digital setting</p> <p>2 : VI setting (VI-GND)</p> <p>3: CI setting (CI-GND)</p> <p>5 : PULSE setting</p> <p>6 : Multi-reference</p> <p>7 : Simple PLC</p> <p>8 : PID setting</p> <p>9 : 485 communication setting</p> <p>Ten's digit : Binding terminal command to frequency source</p> <p>Hundred's digit: Binding communication command to frequency source</p> <p>Thousand's digit:Binding running command to frequency source</p>	0001	0000	○
P0.25	G/P type display	1 : G type	1	Model	*

		2 : P type		dependent	
P0.26	Motor parameter group selection	0 : Motor parameter group 1 1 : Motor parameter group 2 2 : Motor parameter group 3 3 : Motor parameter group 4	1	0	×
P0.27	Serial communication protocol	0:MODBUS protocol	1	0	×

Group P1: Start/Stop Parameter

Function Code	Parameter Name	Setting Range	Minimum Unit	Default	Property
P1.00	Start mode	0 : Direct start 1 : Rotational speed tracking restart 2 : Pre-excited start	1	0	○
P1.01	Startup frequency	0.00~10.00Hz	0.01Hz	0.00Hz	○
P1.02	Startup frequency holding time	0.0~100.0s	0.1s	0.0s	×
P1.03	Startup DC braking current/ Pre-excited current	0%~100%	1%	0%	×
P1.04	Startup DC braking time/ Pre-excited time	0.0~100.0s	0.1s	0.0s	×
P1.05	Stop mode	0 : Decelerate to stop 1 : Coast to stop	1	0	○
P1.06	Initial frequency of	0.00Hz to maximum	0.00Hz	0.00Hz	○

	stop DC braking	frequency			
P1.07	Waiting time of stop DC braking	0.0~100.0s	0.1s	0.0s	○
P1.08	Stop DC braking time	0.0~100.0s	0.1s	0.0s	○
P1.09	Stop DC braking current	0%~100%	1%	0%	○
P1.10	Brake use ratio	0%~100%	1%	100%	○
P1.11	Rotational speed tracking mode	0 : From frequency at stop 1 : From zero speed 2: From maximum frequency	1	0	×
P1.12	Rotational speed tracking speed	1~100	1	20	○
P1.13	Acceleration/Deceleration mode	0 : Linear acceleration/ deceleration 1 : S-curve acceleration/ deceleration	1	0	×
P1.14	Time proportion of S-curve start segment	0.0%~ (100.0%~P1.15)	0.1%	30.0%	×
P1.15	Time proportion of S-curve end segment	0.0%~ (100.0%~P1.14)	0.1%	30.0%	×
Group P2: Auxiliary Functions					
Function Code	Parameter Name	Setting Range	Minimum Unit	Default	Property
P2.00	JOG running fre	0.10 Hz to maximum frequency	0.01Hz	5.00Hz	○

	quency				
P2.01	JOG acceleration time	0.1~6500.0s	0.1s	Model dependent	○
P2.02	JOG deceleration time	0.1~6500.0s	0.1s	Model dependent	○
P2.03	Acceleration time 2	0.1~6500.0s	0.1	Model dependent	○
P2.04	Deceleration time 2	0.1~6500.0s	0.1	Model dependent	○
P2.05	Acceleration time 3	0.1~6500.0s	0.1	Model dependent	○
P2.06	Deceleration time 3	0.1~6500.0s	0.1	Model dependent	○
P2.07	Acceleration time 4	0.1~6500.0s	0.1	Model dependent	○
P2.08	Deceleration time 4	0.1~6500.0s	0.1	Model dependent	○
P2.09	Jump frequency 1	0.0Hz to maximum frequency	0.01Hz	0.00Hz	○
P2.10	Jump frequency 2	0.0Hz to maximum frequency	0.01Hz	0.00Hz	○
P2.11	Jump frequency amplitude	0.0Hz to maximum frequency	0.01Hz	0.00Hz	○
P2.12	Forward/Reverse rotation dead-zone time	0.0S~3000.0s	0.1s	0.0s	○
P2.13	Reverse control	0: Enabled 1 : Disabled	0	0	○

P2.14	Running mode when set frequency lower than frequency lower limit	0 : Run at frequency lower limit 1 : Stop 2 : Run at zero speed	0	0	○
P2.15	Drop control	0.00HZ~10.00HZ	0.01HZ	0.00HZ	○
P2.16	Accumulative power-on time threshold	0h~65000h	1h	0h	○
P2.17	Accumulative running time threshold	0h~65000h	1h	0h	○
P2.18	Startup protection	0 : NO 1 : YES	1	0	○
P2.19	Frequency detection value (FDT1)	0.00Hz to maximum frequency	0.01Hz	50.00Hz	○
P2.20	Frequency detection hysteresis (FDT1)	0.0%~100.0%(FDT1 level)	0.1%	5.0%	○
P2.21	Detection range of frequency reached	0.0%~100.0% (maximum frequency)	0.1%	0.0%	○
P2.22	Jump frequency during acceleration	0 : Disabled 1 : Enabled	1	0	○

	/deceleration				
P2.23	Frequency switchover point between acceleration time 1 and acceleration time 2	0.00Hz to maximum frequency	0.01Hz	0.00HZ	○
P2.24	Frequency switchover point between deceleration time 1 and deceleration time 2	0.00Hz to maximum frequency	0.01Hz	0.00HZ	○
P2.25	Terminal JOG preferred	0 : Disabled 1 : Enabled	1	0	○
P2.26	Frequency detection value (FDT2)	0.00Hz to maximum frequency	0.01Hz	50.00Hz	○
P2.27	Frequency detection hysteresis (FDT2)	0.0%~100.0%(FDT2 level)	0.1%	5.0%	○
P2.28	Any frequency reaching detection value 1	0.00Hz to maximum frequency	0.01HZ	50.00Hz	○

P2.29	Any frequency reaching detection amplitude 1	0.0%~100.0% (maximum frequency)	0.1%	0.0%	○
P2.30	Any frequency reaching detection value 2	0.00Hz to maximum frequency	0.01HZ	50.00Hz	○
P2.31	Any frequency reaching detection amplitude 2	0.0%~100.0% (maximum frequency)	0.1%	0.0%	○
P2.32	Zero current detection level	0.0 %~300.0 %(100.0% rated motor current)	0.1%	5.0%	○
P2.33	Zero current detection delay time	0.01S~600.00S	0.01S	0.10S	○
P2.34	Output overcurrent threshold	0.1 %~300.0 %(100.0% rated motor current)	0.1%	200.0%	○
P2.35	Output overcurrent detection delay time	0.01S~600.00S	0.01S	0.00S	○
P2.36	Any current reaching 1	0.0 %~300.0 %(100.0% rated motor current)	0.1%	100.0 %	○
P2.37	Any current reaching 1	0.0 %~300.0 %(100.0% rated motor current)	0.1%	0.0 %	○

	amplitude				
P2.38	Any current reaching 2	0.0 %~300.0 %(100.0% rated motor current)	0.1%	100.0 %	○
P2.39	Any current reaching 2 amplitude	0.0 %~300.0 %(100.0% rated motor current)	0.1%	0.0 %	○
P2.40	Timing function	0 : Disabled 1 : Enabled	1	0	○
P2.41	Timing duration selection	0: P2.42 setting 1 : VI 2 : CI	1	0	○
P2.42	Timing duration	0.0Min~6500.0Min	0.1Min	0.0Min	○
P2.43	VI input voltage lower limit	0.00V~P2.44	0.01V	3.10V	○
P2.44	VI input voltage upper limit	P2.44~10.00V	0.01V	6.80V	○
P2.45	Module temperature threshold	0~100°C	1	75°C	○
P2.46	Cooling fan control	0 : Fan working during running 1 : Fan working continuously	1	0	○
P2.47	Wakeup frequency	Dormant frequency (P2.49) ~maximum frequency	0.01HZ	0.00HZ	○
P2.48	Wakeup delay time	0.0S~6500.0S	0.1S	0.0S	○
P2.49	Dormant frequency	0.00Hz to wakeup frequency P2.47	0.01HZ	0.00HZ	○
P2.50	Dormant delay	0.0S~6500.0S	0.1S	0.0S	○

	time				
P2.51	Current running time reached	0.0~6500.0Min	0.1Min	0.0Min	○

Group P3 : Input Terminals

Function Code	Parameter Name	Setting Range	Minimum Unit	Default	Property
P3.00	X1 function selection	0 : No function 1: Forward RUN (FWD) 2 : Reverse RUN (REV) 3 : Three-line control 4 : Forward JOG (FJOG) 5 : Reverse JOG (RJOG) 6 : Terminal UP 7 : Terminal DOWN 8 : Coast to stop (FRS) 9 : Fault reset 10 : RUN pause 11 : Normally open(NO) input of external fault 12 : Mult-reference terminal 1 13 : Mult-reference terminal 2 14 : Mult-reference terminal 3 15 : Mult-reference terminal 4	1	1	×

		<p>16 : Terminal 1 for acceleration /deceleration time selection</p> <p>17 : Terminal 2 for acceleration /deceleration time selection</p> <p>18 : Frequency source switchover</p> <p>19 : UP/DOWN setting clear (terminal, operation panel)</p> <p>20 : Command source switchover 1</p> <p>21 : Acceleration/Deceleration prohibited</p> <p>22 : PID pause</p> <p>23 : PLC status reset</p> <p>24 : Swing pause</p> <p>25 : Counter input</p> <p>26 : Counter reset</p> <p>27 : Length count input</p> <p>28 : Length reset</p> <p>29 : Torque control prohibited</p> <p>30 : PULSE input (enabled only for X5)</p> <p>31 : Reserved</p>			
--	--	--	--	--	--

		<p>32 : Immediate DC braking</p> <p>33 : Normally closed(NC)input of external fault</p> <p>34 : Frequency modification forbidden</p> <p>35 : Reverse PID action direction</p> <p>36 : External STOP terminal 1</p> <p>37 : Command source switchover terminal 2</p> <p>38 : PID integral pause</p> <p>39 : Switchover between main frequency source X and preset frequency</p> <p>40 : Switchover between main frequency source Y and preset frequency</p> <p>41 : Motor selection terminal 1</p> <p>42 : Reserved</p> <p>43 : PID parameter switchover</p> <p>44: User-defined fault 1</p> <p>45 : User-defined fault 2</p> <p>46 : Speed control/Torque</p>			
--	--	---	--	--	--

		control switchover 47 : Emergency stop 48 : External STOP terminal 2 49 : Deceleration DC braking 50 : Clear the current running time 51 : Switchover between two-line mode and three-line mode 52 : Reverse forbidden 53~59 : Reserved			
P3.01	X2 function selection	Same as above	1	4	×
P3.02	X3 function selection	Same as above	1	9	×
P3.03	X4 function selection	Same as above	1	12	×
P3.04	X5 function selection	Same as above	1	13	×
P3.05	X6 function selection	Same as above	1	0	×
P3.06	X7 function selection	Same as above	1	0	×
P3.07	X8 function selection	Reserved	1	0	×

P3.08	X9 function selection	Reserved	1	0	×
P3.09	X10 function selection	Reserved	1	0	×
P3.10	VI function selection (DI)	0~59	1	1	×
P3.11	CI function selection (DI)	0~59	1	1	×
P3.13	Terminal filter time	0.000S~1.000S	1	0.010S	×
P3.14	Terminal command mode	0 : Two-line mode 1 1 : Two-line mode 2 2 : Three -line mode 1 3 : Three -line mode 2	0	0	○
P3.15	Terminal UP/DOWN rate	0.001HZ/S ~ 65.535HZ/S	0.001Hz/s	1.00HZ/S	○
P3.16	VI minimum input	0.00V ~ P3.15	1	0.00V	○
P3.17	Corresponding setting of VI minimum input	-100.0% ~ +100.0%	1	0.0%	○
P3.18	VI maximum input	P3.13 ~ +10.00V	0.01V	10.00V	○
P3.19	Corresponding setting of VI maximum input	-100.0% ~ +100.0%	0.01Hz	100.0%	○
P3.20	VI filter time	0.00S ~ 10.00S	0.01S	0.10S	○
P3.21	CI minimum input	0.00V ~ P3.20	0.01V	0.00V	○
P3.22	Corresponding setting of CI	-100.0% ~ +100.0%	0.1%	0.0%	○

	minimum input				
P3.23	CI maximum input	P3.18 ~ +10.00V	0.01V	10.00V	○
P3.24	Corresponding setting of CI maximum input	-100.0% ~ +100.0%	0.01Hz	100.0%	○
P3.25	CI filter time	0.00S ~ 10.00S	0.01S	0.10S	○
P3.31	Pulse minimum input	0.00KHZ ~ P3.30	0.01V	0.00KH Z	○
P3.32	Corresponding setting of pulse minimum input	-100.0% ~ +100.0%	0.1%	0.0%	○
P3.33	Pulse maximum input	P3.28 ~ 100.00KHZ	0.01V	50.00K HZ	○
P3.34	Corresponding setting of pulse maximum input	-100.0% ~ +100.0%	0.1%	100.0%	○
P3.35	Pulse filter time	0.00S ~ 10.00S	0.01S	0.10S	○
P3.36	VI curve selection	Unit's digit : VI curve selection 1 : Curve1 (2 points, see P3.16~P3.19) 2 : Curve 2 (2 points, see P3.21~P3.24) 3 : Curve 3 (2 points, see P3.26~P3.29) 4 : Curve 4 (4 points, see PF.20~PF.27)	111	321	○

		5 : Curve 5 (4 points, see PF.28~PF.35) Ten's digit : CI curve selection, same as VI			
P3.37	Setting for AI less than minimum input	Unit's digit : setting for VI less than minimum input 0 : Minimum value 1 : 0.0% Ten's digit : setting for CI less than minimum input	111	000	○
P3.38	X1 delay time	0.0S~ 3600.0S	0.1S	0.0S	×
P3.39	X2 delay time	0.0S~ 3600.0S	0.1S	0.0S	×
P3.40	X3 delay time	0.0S~ 3600.0S	0.1S	0.0S	×
P3.41	X valid mode selection 1	0: High level valid 1 : Low level valid Unit's digit : X1 Ten's digit : X2 Hundred's digit : X3 Thousand's digit : X4 Ten thousand's digit : X5	11111	00000	×
P3.42	X valid mode selection 2	0: High level valid 1 : Low level valid Unit's digit : X6 Ten's digit : X7 Hundred's digit : X8 Thousand's digit : X9 Ten thousand's digit : X10	11111	00000	×

P3.43	AI as valid status selection of DI	0 : High level valid 1 : Low level valid Unit's digit : VI Ten's digit : CI	111	111	×
-------	------------------------------------	--	-----	-----	---

Group P4: Output Terminals

Function Code	Parameter Name	Setting Range	Minimum Unit	Default	Property
P4.00	FM terminal output mode	0 : Pulse output (FMP) 1 : Switch signal output (FMR)	1	0	○
P4.01	FM function(open-collector output terminal)	0 : No output 1 : AC drive running 2 : Fault output (stop) 3 : Frequency-level detection	1	0	○
P4.02	Relay function T/A-T/B-T/C	FDT1 output 4 : Frequency reached	1	2	○
P4.03	Extension card relay function (R/A-R/B-R/C)	5 : Zero-speed running(no output at stop) 6 : Motor overload pre-warning 7 : AC drive overload pre-	1	0	○
P4.04	DO1 function selection (Reserved)	warning 8 : Set count value reached 9 : Designated count value reached	1	1	○

P4.05	DO2 function selection (Reserved)	10 : Length reached 11 : PLC cycle complete 12 : Accumulative running time reached 13: Frequency limited 14 : Torque limited 15 : Ready for RUN 16 : VI > CI 17: Frequency upper limit reached 18 : Frequency lower limit reached 19 : Under voltage state output 20 : Communication setting 21 : Positioning complete 22 : Positioning approach 23 : Zero-speed running 2 (having output at stop) 24 : Accumulative power-on time reached 25 : Frequency level detection FDT2 output 26 : Frequency 1 reached 27 : Frequency 2 reached 28 : Current 1 reached 29 : Current 2 reached 30 : Timing reached 31 : VI input limit exceeded	1	4	○
-------	-----------------------------------	--	---	---	---

P4.06	FMP function selection	0 : Running frequency 1 : Set frequency 2 : Output current	1	0	○
P4.07	AO1 function selection	3 : Output torque 4 : Output power 5 : Output voltage 6 : Pulse input (100.0% at	1	0	
P4.08	AO2 function selection	100.0KHZ) 7 : VI 8 : CI 10 : Length 11 : Count value 12 : Communication setting 13 : Motor rotational speed 14 : Output current (100.0% at 1000.0A) 15 : Output voltage (100.0% at 1000.0V) 16 : Output torque (actual value)	1	1	
P4.09	Maximum FMP output frequency	0.01KHZ ~ 100.00KHZ	0.01KHZ	50.00KHZ	○
P4.10	AO1 offset coefficient	-100.0% ~ +100.0%	0.001	0.0%	○
P4.11	AO1 gain	-10.00 ~ +10.00	0.01	1.00	○
P4.12	AO2 offset coefficient	-100.0% ~ +100.0%	0.001	0.0%	○

P4.13	AO2 gain	-10.00 ~ +10.00	0.01	1.00	○
P4.14	FMR output delay time	0.0S ~ 3600.0S	0.1s	0.0s	○
P4.15	Relay 1 output delay time	0.0S ~ 3600.0S	0.1s	0.0s	○
P4.16	Relay 2 output delay time	0.0S ~ 3600.0S	0.1s	0.0s	○
P4.17	DO1 output delay time	0.0S ~ 3600.0S	0.1s	0.0s	○
P4.18	DO2 output delay time	0.0S ~ 3600.0S	0.1s	0.0s	○
P4.19	DO valid mode selection	0: Positive logic 1: Negative logic Unit's digit: FMR Ten's digit: RELAY1 Hundred's digit: RELAY2 Thousand's digit: DO1 Ten thousand's digit: DO2	11111	00000	○
Group P5: V/F Control Parameters					
Function Code	Parameter Name	Setting Range	Minimum Unit	Default	Property
P5.00	V/F curve setting	0: Linear V/F 1: Multi-point V/F 2: SquareV/F 3:1.2-power V/F 4:1.4-power V/F 6:1.6-power V/F	1	0	×

		8:1.8-power V/F 9: Reserved 10 : V/F complete separation 11 : V/F half separation			
P5.01	Torque boost	0.0%(fixed torque boost) 0.1% ~ 30.0%		Model depende nt	○
P5.02	Cut-off frequency of torque boost	0.00HZ to maximum output frequency	0.01HZ	50.00HZ	×
P5.03	Multi-point V/F frequency 1 (F1)	0.00HZ ~ P5.05	0.01HZ	0.00HZ	×
P5.04	Multi-point V/F voltage 1 (V1)	0.0% ~ 100.0%	0.1%	0.0%	×
P5.05	Multi-point V/F frequency 2 (F2)	P5.03 ~ P5.07	0.01HZ	0.00HZ	×
P5.06	Multi-point V/F voltage 2(V2)	0.0% ~ 100.0%	0.1%	0.0%	×
P5.07	Multi-point V/F frequency 3 (F3)	P5.05 to rated motor frequency	0.01HZ	0.00HZ	×
P5.08	Multi-point V/F voltage 3 (V3)	0.0% ~ 100.0%	0.1%	0.0%	×
P5.09	V/F slip compensation gain	0.0% ~ 200.0%	0.1%	0.0%	○
P5.10	V/F over- excitation gain	0 ~ 200	1	64	○
P5.11	V/F oscillation	0 ~ 100	1	Model	○

	suppression gain			dependent	
P5.13	Voltage source for V/F separation	0 : Digital setting 1 : VI 2 : CI 4 : Pulse setting 5 : Multi-reference 6 : Simple PLC 7 : PID 8 : Communication setting (100.0% corresponds to the rated motor voltage)	1	0	○
P5.14	Voltage digital setting for V/F separation	0V to rated motor voltage	1	0V	○
P5.15	Voltage rise time of V/F separation	0.0S ~ 1000.0S	0.1S	0.0S	○

Group P6: PID Function

Function Code	Parameter Name	Setting Range	Minimum Unit	Default	Property
P6.00	PID setting source	0 : P6.01 setting 1 : VI 2 : CI 4 : Pulse setting 5 : Communication setting 6 : Multi-reference	1	0	○

P6.01	PID digital setting	0.0% ~ 100.0%	1	50	○
P6.02	PID feedback source	0 : VI 1 : CI 3 : VI-CI 4 : Pulse setting 5 : Communication setting 6 : VI+CI 7 : MAX(VI + CI) 8 : MIN(VI , CI)	1	0	○
P6.03	PID action direction	0 : Forward action 1 : Reverse action	1	0	○
P6.04	PID setting feedback range	0 ~ 65535	1	1000	○
P6.05	Proportional gain KP1	0.0 ~ 100.0	0.1	20.0	○
P6.06	Integral time TI1	0.01S ~ 10.00S	0.01S	2.00S	○
P6.07	Differential time TD1	0.000S ~ 10.000S	0.001S	0.000S	○
P6.08	Cut-off frequency of PID reverse rotation	0.00 to maximum frequency	0.01	2.00HZ	○
P6.09	PID deviation limit	0.0% ~ 100.0%	0.1%	0.0%	○
P6.10	PID differential limit	0.00% ~ 100.00 %	0.01%	0.10%	○
P6.11	PID setting	0.00 ~ 650.00S	0.01S	0.00S	○

	change time				
P6.12	PID feedback filter time	0.00 ~ 60.00S	0.01S	0.00S	○
P6.13	PID output filter time	0.00 ~ 60.00S	0.01S	0.00S	○
P6.14	Reserved				○
P6.15	Proportional gain KP2	0.0 ~ 100.0	0.1	20.0	○
P6.16	Integral time TI2	0.01S ~ 10.00S	0.01	2.00S	○
P6.17	Differential time TD2	0.000S ~ 10.000S	0.001S	0.000S	○
P6.18	PID parameter switchover condition	0 : No switchover 1 : Switchover via Xi 2 : Automatic switchover based on deviation 3 : Automatic switchover based on running frequency	0.01	0	○
P6.19	PID parameter switchover deviation 1	0.0% ~ P6.20	0.1%	20.0%	○
P6.20	PID parameter switchover deviation 2	P6.19 ~ 100.0 %	0.1%	80.0%	○
P6.21	PID initial value	0, 0% ~100.0 %	1	0, 0%	○
P6.22	PID initial value holding time	0.00 ~ 650.00S	0.01S	0.00S	○
P6.23	Maximum	0.00% ~ 100.00%	0.01%	1.00%	○

	deviation between two PID outputs in forward direction				
P6.24	Maximum deviation between two PID outputs in reverse direction	0.00% ~ 100.00%	0.01%	1.00%	○
P6.25	PID integral property	Unit's digit : Integral separated 0 : Invalid 1 : Valid Ten's digit : whether to stop integral operation when the output reaches the limit 0 : Continue integral operation 1 : Stop integral operation	00~11	00	○
P6.26	Detection value of PID feedback loss	0.0% : Not judging feedback loss 0.1% ~100.0%	0.01Hz	0.0%	○
P6.27	Detection time of PID feedback loss	0. 0S ~20.0S	0.1S	1.0S	○
P6.28	PID operation at stop	0 : No PID operation at stop 1 : PID operation at stop	1	0	○

Group P7: Operation Panel and Display

Function Code	Parameter Name	Setting Range	Minimum Unit	Default	Property
P7.00	REV key function selection	0 : RVE key disabled 1 : Switchover between operation panel control and remote command control (terminal or communication) 2 : Switchover between forward rotation and reverse rotation 3 : Forward JOG 4 : Reverse JOG	1	2	○
P7.01	STOP key function	0 : STOP key enabled only in operation panel control 1 : STOP key enabled in any operation mode	1	1	○

P7.02	LED display running parameters 1	0000~FFFF Bit00: Running frequency 1(Hz) Bit01: Set frequency (Hz) Bit02: Bus voltage(V) Bit03: Output voltage(V) Bit04: Output current(A) Bit05: Output power(KW) Bit06: Output torque (%) Bit07:DI input status Bit08:DO output status Bit09:A/1 voltage (V) Bit10:A/2 voltage (V) Bit11:A/3 voltage (V) Bit12: Count value Bit13: Length value Bit14: Load speed display Bit15:PID setting	1	001F	○
P7.03	LED display running parameters 2	0000~FFFF Bit00:PID feedback Bit01:PLC stage Bit02:Pulse setting frequency (kHz) Bit03: Running frequency 2 (HZ) Bit04: Remaining running time Bit05:A/1 voltage before	0.1	0000	○

		<p>correction (V)</p> <p>Bit06:A/2 voltage before correction (V)</p> <p>Bit07:A/3 voltage before correction (V)</p> <p>Bit08: Linear speed</p> <p>Bit09: Current power-on time (Hour)</p> <p>Bit10: Current running time (Min)</p> <p>Bit11: Pulse setting frequency (kHz)</p> <p>Bit12: Communication setting value</p> <p>Bit13: Encoder feedback speed</p> <p>Bit14: Main frequency X display (HZ)</p> <p>Bit15: Auxiliary frequency Y display (HZ)</p>			
P7.04	LED display stop parameters	<p>0000~FFFF</p> <p>Bit00: Set frequency (HZ)</p> <p>Bit01: Bus voltage(V)</p> <p>Bit02:DI input status</p> <p>Bit03:DO output status</p> <p>Bit04:A/1 voltage (V)</p> <p>Bit05:A/2 voltage (V)</p>	1	0033	○

		Bit06:A/3 voltage (V) Bit07: Count value Bit08: Length value Bit09:PLC stage Bit10: Load speed Bit11:PID setting Bit12:Pulse setting frequency (kHz)			
P7.05	Load speed display coefficient	0.0001~6.5000	0.0001	1.0000	○
P7.06	Heatsink temperature of inverter module	0.0°C~100.0°C	1	000	*
P7.07	Product number	0.00~10.00	0.01	-	*
P7.08	Accumulative running time	0H~65535h	1	000	*
P7.09	Software version 1	0.00~10.00	0.01	9000	*
P7.10	Software version 2	0.00~10.00	0.01	0.55	*
P7.11	Number of decimal places for load speed display	Unit's digit : U0-14 number of decimal places 0:0 decimal place 1:1 decimal place 2:2 decimal place 3:3 decimal place	0.1	10.0	○

		Ten's digit : U0-19/U0-29 number of decimal places 1:1 decimal place 2:2 decimal place			
P7.12	Accumulative power-on time	0 ~ 65535h	1	000	*
P7.13	Accumulative power consumption	0 ~ 65535kw□h	0.1	0	*
Group P8: Motor Parameters					
Function Code	Parameter Name	Setting Range	Minimum Unit	Default	Property
P8.00	Motor type selection	0 : Common asynchronous motor 1 : Variable frequency asynchronous motor	1	0	×
P8.01	Rated motor power	0.1KW~1000.0KW	0.1KW	Model dependent	×
P8.02	Rated motor voltage	1V~2000V	1V	Model dependent	×
P8.03	Rated motor current	0.01A~655.35A(AC power≤55KW) 0.1A~6553.5A(AC power≥55KW)	0.01A	Model dependent	×
P8.04	Rated motor frequency	0.01Hz to maximum frequency	0.01Hz	Model dependent	×
P8.05	Rated motor	1rpm~65535rpm	1rpm	Model	×

	rotational speed			dependent	
P8.06	Stator resistance (asynchronous motor)	0.001Ω~65.535Ω(AC powers≤55KW) 0.0001Ω~6.5535Ω(AC power≥55KW)	0.001Ω	Tuning parameter	×
P8.07	Rotor resistance (asynchronous motor)	0.001Ω~65.535Ω(AC powers≤55KW) 0.0001Ω~6.5535Ω(AC power≥55KW)	0.001Ω	Tuning parameter	×
P8.08	Leakage inductive reactance (asynchronous motor)	0.01mH~655.35mH(AC powers≤55KW) 0.001mH~65.535mH(AC power≥55KW)	0.01mH	Tuning parameter	×
P8.09	Mutual inductive reactance (asynchronous motor)	0.01mH~6553.5mH(AC powers≤55KW) 0.01mH~655.35mH(AC power≥55KW)	0.1mH	Tuning parameter	×
P8.10	No-load current (asynchronous motor)	0.01A~P8.03(AC powers≤55KW) 0.01A~P8.03(AC power≥55KW)	0.01	Tuning parameter	×
P8.27	Encoder pulses per revolution	1~65535	1	1024	×
P8.28	Encoder type	0: ABZ incremental encoder 1: UVW incremental encoder 2: Resolver	1	0	×

		3: SIN/COS encoder 4: Wire-saving UVW encoder			
P8.29	Reserved				
P8.30	A,B phase sequence of ABZ incremental encoder	0: Forward 1: Reverse	1	0	×
P8.31	Encoder installation angle	0.0~359.9°	0.1°	1	×
P8.32	U,V,W phase sequence of UVW encoder	0: Forward 1: Reverse	1	0	×
P8.33	UVW encoder angle offset	0.0~359.9°	0.1°	0.0°	×
P8.34	Number of pole pairs of resolver	1~65535	1	1	×
P8.37	Auto-tuning selection	0: No auto-tuning 1: Asynchronous motor static auto-tuning 2: Asynchronous motor with- load auto-tuning	1	0	×
Group P9: Vector Control Parameters					
Function Code	Parameter Name	Setting Range	Minimum Unit	Default	Property
P9.00	Speed/Torque control mode	0: Speed control 1: Torque control	1	0	×

P9.01	Speed loop proportional gain 1	1~100	1	30	○
P9.02	Speed loop integral time1	0.01s~10.00s	0.01s	0.50S	○
P9.03	Switchover frequency 1	0.00~P9.06	0.01Hz	5.00HZ	○
P9.04	Speed loop proportional gain 2	1~100	1	20	○
P9.05	Speed loop integral time 2	0.01s~10.00s	0.01s	1.00s	○
P9.06	Switchover frequency 2	P9.02~to maximum output frequency	0.01Hz	10.00Hz	○
P9.07	Vector control slip gain	50%~200%	0.01	100%	○
P9.08	Time constant of speed loop filter	0.000s~0.100s	0.001s	28	○
P9.09	Vector control over-excitation gain	0~200	1	64	○
P9.10	Torque upper limit source in speed control mode	0 : P9.11 setting 1 : VI 2 : CI 4 : Pulse setting 5 : Communication setting 6 : MIN(VI, CI)	1	0	○

		7 : MAX(VI, CI)			
P9.11	Digital setting of torque upper limit in speed control mode	0.0%~200.0%	0.001	150.0%	○
P9.12	Torque upper limit source in speed control(stop) mode	0: P9.13 setting 1 : VI 2 : CI 4 : Pulse setting 5 : Communication setting 6 : MIN(VI, CI) 7 : MAX(VI, CI)	1	0	○
P9.13	Digital setting of torque upper limit in speed control(stop) mode	0.0%~200.0%	0.001	150.0%	○
P9.14	Excitation adjustment proportional gain	0~60000	1	2000	○
P9.15	Excitation adjustment integral gain	0~60000	1	1300	○
P9.16	Torque adjustment proportional gain	0~60000	1	2000	○

P9.17	Torque adjustment integral gain	0~60000	1	1300	○
P9.18	Speed loop integral property	Unit's digit : integral separation 0 : Disabled 1 : Enabled	1	0	○
P9.24	Driving torque upper limit source	0 : Digital setting1(P9.26) 1 : VI 2 : CI 4 : Pulse setting 5 : Communication setting 6 : MIN(VI, CI) 7 : MAX(VI, CI)	1	0	×
P9.25	Reserved	-	-	-	*
P9.26	Digital setting of torque upper limit in torque control mode	-200.0%~200.0%	0.1%	150.0%	○
P9.27	Torque filter	-	-	-	*
P9.28	Maximum forward frequency in torque control mode	0.00Hz~maximum frequency	0.01Hz	50.00Hz	○
P9.29	Maximum reverse	0.00Hz~maximum frequency	0.01Hz	50.00Hz	○

	frequency in torque control mode				
P9.30	Acceleration time of torque control	0.00s~65000s	0.01s	0.00s	○
P9.31	Deceleration time of torque control	0.00s~65000s	0.01s	0.00s	○

Group PA: Fault and Protection

Function Code	Parameter Name	Setting Range	Minimum Unit	Default	Property
PA.00	Motor overload protection selection	0: Disabled 1: Enabled		1	○
PA.01	Motor overload protection gain	0.20~10.00		1.00	○
PA.02	Motor overload protection coefficient	50%~100%		80%	○
PA.03	Over voltage stall gain	0~100		0	○
PA.04	Over voltage stall protective current	120%~150%		130%	○
PA.05	Over current stall	0~100		20	○

	gain				
PA.06	Over current stall protective current	100%~200%		150%	○
PA.07	Short-circuit to ground upon power-on	0 : Disabled 1 : Enabled		1	○
PA.09	Fault auto reset times	0~20		0	○
PA.10	DO action during fault auto reset	0 : Not act 1 : Act		0	○
PA.11	Time interval of fault auto reset	0.1s~100.0s		1.0s	○
PA.12	Input phase loss protection/contact energizing	Unit's digit : Input phase loss protection Ten's digit : Contactor energizing protection 0 : Disabled 1 : Enabled		11	○
PA.13	Output phase loss protection selection	0 : Disabled 1 : Enabled		1	○
PA.14	1st fault type	0 : No fault	-	-	*
PA.15	2nd fault type	1 : Over current during	-	-	*

PA.16	3rd (latest) fault type	<p>acceleration (E-01)</p> <p>2 : Over current during deceleration (E-02)</p> <p>3 : Over current at constant speed (E-03)</p> <p>4 : Over voltage during acceleration (E-04)</p> <p>5 : Over voltage during deceleration (E-05)</p> <p>6 : Over voltage at constant speed (E-06)</p> <p>7 : Contactor fault (E-07)</p> <p>8 : AC drive overheat (E-08)</p> <p>9 : AC drive overload (E-09)</p> <p>10: Motor overload (E-10)</p> <p>11 : Under voltage (E-11)</p> <p>12 : Power output phase loss (E-12)</p> <p>13 : External equipment fault (E-13)</p> <p>14 : Current detection fault (E-14)</p> <p>15: Communication fault (E-15)</p> <p>16: System interference (E-16)</p> <p>17 : EEPROM read/write</p>	-	-	*
-------	-------------------------	---	---	---	---

PA.17	Frequency upon 3 rd fault	-	-	-	*
PA.18	Current upon 3 rd fault	-	-	-	*
PA.19	Bus voltage upon 3 rd fault	-	-	-	*
PA.20	Input terminal status upon 3 rd fault	-	-	-	*
PA.21	Output terminal status upon 3 rd fault	-	-	-	*
PA.22	AC drive status upon 3 rd fault	-	-	-	*
PA.23	Power-on time upon 3 rd fault	-	-	-	*
PA.24	Running time upon 3 rd fault	-	-	-	*
PA.25	Frequency upon 2 nd fault	-	-	-	*
PA.26	Current upon 2 nd fault	-	-	-	*
PA.27	Bus voltage upon 2 nd fault	-	-	-	*
PA.28	Input terminal status upon 2 nd fault	-	-	-	*

PA.29	Output terminal status upon 2nd fault	-	-	-	*
PA.30	AC drive status upon 2 nd fault	-	-	-	*
PA.31	Power-on time upon 2 nd fault	-	-	-	*
PA.32	Running time upon 2 nd fault	-	-	-	*
PA.33	Frequency upon 1 st fault	-	-	-	*
PA.34	Current upon 1 st fault	-	-	-	*
PA.35	Bus voltage upon 1 st fault	-	-	-	*
PA.36	Input terminal status upon 1 st fault	-	-	-	*
PA.37	Output terminal status upon 1 st fault	-	-	-	*
PA.38	AC drive status upon 1 st fault	-	-	-	*
PA.39	Power-on time upon 1 st fault	-	-	-	*
PA.40	Running time upon 1 st fault	-	-	-	*

PA.43	Fault protection action selection1	Unit's digit : Motor overload (E-11) 0 : Coast to stop 1 : Stop according to the stop mode 2 : Continue to run Ten's digit : Power output phase loss (E-12) Hundred's digit : External equipment fault(E-15) Thousand's digit : Communication fault (E-16) Ten thousand's digit : EEPROM read-write fault (E- 17)	11111	00000	○
PA.44	Fault protection action selection 2	Unit's digit : Power input phase loss (E-19) 0 : Coast to stop Ten's digit : Encoder fault (E- 21) 0 : Coast to stop 1 : Stop according to the stop mode Hundred's digit : Accumulative running time reached Thousand's digit :	11111	00000	○

		Accumulative power-on time reached(E-24) Ten thousand's digit : Motor overheat (E-27)			
PA.45	Fault protection action selection 3	Unit's digit : Too large speed deviation (E-28) Ten's digit : Motor over-speed (E-29) Hundred's digit : Load becoming 0 (E-31) Thousand's digit : PID feedback lost during running (E-34) Ten thousand's digit : Reserved	11111	00000	○
PA.46	Fault protection action selection 4	Unit's digit : User-defined fault 1 (E-32) 0 : Coast to stop 1 : Stop according to the stop mode 2 : Continue to run Ten's digit : User-defined fault 2 (E-33) Hundred's digit: Reserved	11111	00000	○
PA.50	Frequency selection for continuing to run	0 : Current running frequency 1 : Set frequency 2 : Frequency upper limit	1	0	○

	upon fault	3 : Frequency lower limit 4 : Backup frequency upon abnormality			
PA.51	Backup frequency upon abnormality	0.0%~100.0% (100.0% to maximum frequency)	0.001	100.0%	○
PA.53	Motor overheat protection threshold	0°C~200°C	1°C	110°C	○
PA.54	Motor overheat warning threshold	0°C~200°C	1°C	90°C	○
PA.55	Action selection at instantaneous power failure	0 : Invalid 1 : Decelerate 2 : Deceleration to stop	1	0	○
PA.56	Action pause judging voltage at instantaneous power failure	80.0%~100.0%	0.01Hz	90.0%	○
PA.57	Voltage rally judging time at instantaneous power failure	0.00s~100.00s	0.01s	0.50s	○
PA.58	Action judging voltage at instantaneous power failure	60.0%~100.0% (Standard bus voltage)	0.10%	80.0%	○

PA.59	Protection upon load becoming 0	0 : Disabled 1 : Enabled	1	0	○
PA.60	Detection level of load becoming 0	0.0~100.0%	0.001	10.0%	○
PA.61	Detection time of load becoming 0	0.0~60.0s	0.1s	1.0%	○
PA.63	Over-speed detection value	0.0%~50.0% (Maximum frequency)	0.1%	20.0%	○
PA.64	Over-speed detection time	0.0s:Not detected 0.1~60.0s	0.001	1.0s	○
PA.65	Detection value of too large speed deviation	0.0%~50.0% (Maximum frequency)	0.1%	20.0%	○
PA.66	Detection time of too large speed deviation	0.0s: Not detected 0.1~60.0s	0.001	5.0s	○

Group PB: Multi-Reference and Simple PLC Function					
Function Code	Parameter Name	Setting Range	Minimum Unit	Default	Property
Pb.00	Multi-reference 0	-100.0% ~ 100.0%(100.0% to maximum frequency P0.05)	0	0.0%	○
Pb.01	Multi-reference 1	-100.0%~100.0%	0	0.0%	○
Pb.02	Multi-reference 2	-100.0%~100.0%	0	0.0%	○
Pb.03	Multi-reference 3	-100.0%~100.0%	0	0.0%	○
Pb.04	Multi-reference 4	-100.0%~100.0%	0	0.0%	○

Pb.05	Multi-reference 5	-100.0%~100.0%	0	0.0%	○
Pb.06	Multi-reference 6	-100.0%~100.0%	0	0.0%	○
Pb.07	Multi-reference 7	-100.0%~100.0%	0	0.0%	○
Pb.08	Multi-reference 8	-100.0%~100.0%	0	0.0%	○
Pb.09	Multi-reference 9	-100.0%~100.0%	0	0.0%	○
Pb.10	Multi-reference 10	-100.0%~100.0%	0	0.0%	○
Pb.11	Multi-reference 11	-100.0%~100.0%	0	0.0%	○
Pb.12	Multi-reference 12	-100.0%~100.0%	0	0.0%	○
Pb.13	Multi-reference 13	-100.0%~100.0%	0	0.0%	○
Pb.14	Multi-reference 14	-100.0%~100.0%	0	0.0%	○
Pb.15	Multi-reference 15	-100.0%~100.0%	0	0.0%	○
Pb.16	Simple PLC running mode	0 : Stop after AC drive runs one cycle 1 : Keep final values after AC drive runs one cycle 2 : Repeat after AC drive runs one cycle	0	0	○
Pb.17	Simple PLC retentive selection	Unit's digit : Retentive upon power failure 0 : NO 1 : YES	0	00	○

		Ten's digit : Retentive upon stop 0 : NO 1 : YES			
Pb.18	Running time of simple PLC reference 0	0.0s(h)~6553.5s(h)	0	0.0s(h)	○
Pb.19	Deceleration time of simple PLC reference 0	0~3	0	0	○
Pb.20	Running time of simple PLC reference 1	0.0s(h)~6553.5s(h)	0	0.0s(h)	○
Pb.21	Deceleration time of simple PLC reference 1	0~3	0	0	○
Pb.22	Running time of simple PLC reference 2	0.0s(h)~6553.5s(h)	0	0.0s(h)	○
Pb.23	Deceleration time of simple PLC reference 2	0~3	0	0	○
Pb.24	Running time of simple PLC reference 3	0.0s(h)~6553.5s(h)	0	0.0s(h)	○
Pb.25	Deceleration time of simple	0~3	0	0	○

	PLC reference 3				
Pb.26	Running time of simple PLC reference 4	0.0s(h)~6553.5s(h)	0	0.0s(h)	○
Pb.27	Deceleration time of simple PLC reference 4	0~3	0	0	○
Pb.28	Running time of simple PLC reference 5	0.0s(h)~6553.5s(h)	0	0.0s(h)	○
Pb.29	Deceleration time of simple PLC reference 5	0~3	0	0	○
Pb.30	Running time of simple PLC reference 6	0.0s(h)~6553.5s(h)	0	0.0s(h)	○
Pb.31	Deceleration time of simple PLC reference 6	0~3	0	0	○
Pb.32	Running time of simple PLC reference 7	0.0s(h)~6553.5s(h)	0	0.0s(h)	○
Pb.33	Deceleration time of simple PLC reference7	0~3	0	0	○
Pb.34	Running time of simple PLC	0.0s(h)~6553.5s(h)	0	0.0s(h)	○

	reference 8				
Pb.35	Deceleration time of simple PLC reference 8	0~3	0	0	○
Pb.36	Running time of simple PLC reference 9	0.0s(h)~6553.5s(h)	0	0.0s(h)	○
Pb.37	Deceleration time of simple PLC reference 9	0~3	0	0	○
Pb.38	Running time of simple PLC reference 10	0.0s(h)~6553.5s(h)	0	0.0s(h)	○
Pb.39	Deceleration time of simple PLC reference10	0~3	0	0	○
Pb.40	Running time of simple PLC reference 11	0.0s(h)~6553.5s(h)	0	0.0s(h)	○
Pb.41	Deceleration time of simple PLC reference 11	0~3	0	0	○
Pb.42	Running time of simple PLC reference 12	0.0s(h)~6553.5s(h)	0	0.0s(h)	○
Pb.43	Deceleration	0~3	0	0	○

	time of simple PLC reference 12				
Pb.44	Running time of simple PLC reference 13	0.0s(h)~6553.5s(h)	0	0.0s(h)	○
Pb.45	Deceleration time of simple PLC reference 13	0~3	0	0	○
Pb.46	Running time of simple PLC reference 14	0.0s(h)~6553.5s(h)	0	0.0s(h)	○
Pb.47	Deceleration time of simple PLC reference 14	0~3	0	0	○
Pb.48	Running time of simple PLC reference 15	0.0s(h)~6553.5s(h)	0	0.0s(h)	○
Pb.49	Deceleration time of simple PLC reference 15	0~3	0	0	○
Pb.50	Time unit of simple PLC running	0 : s(second) 1 : H (hour)	0	0	○

Pb.51	Multi-reference 0 source	0 : Set by PB.00 1 : VI 2 : CI 4:Pulse setting 5 : PID 6 : Set by preset frequency, modified via terminal UP/DOWN	0	0	○
Group PC: Communication Parameters					
Function Code	Parameter Name	Setting Range	Minimum Unit	Default	Property
PC.00	Baud rate	MODBUS baud rate : 0 : 300BPS 1 : 600BPS 2 : 1200BPS 3 : 2400BPS 4 : 4800BPS 5 : 9600BPS 6 : 19200BPS 7 : 38400BPS 8 : 57600BPS 9 : 115200BPS	1	5	○
PC.01	Modbus data format	0 : No check (8-N-2) 1 : Even parity check (8-E-1) 2 : Odd parity check (8-O-1) 3 : No check (8-N-1) (Valid for MODBUS)	1	0	○

PC.02	Local address	0 : Broadcast address 1~247 (Valid for MODBUS, Profibus- DP, CANlink)	1	1	○
PC.03	Response delay	0~20ms(Valid for MODBUS)	1ms	2	○
PC.04	Communication timeout	0.0 : Invalid 0.1 : ~60.0s	0.1s	0.0	○
PC.05	Modbus protocol data format	MODBUS : 0 : Non-standard Modbus protocol 1 : Standard Modbus protocol	1	0	○
Group Pd: Function Code Management					
Function Code	Parameter Name	Setting Range	Minimum Unit	Default	Property
Pd.00	User password	0~65535	1	0	○
Pd.01	Restore default setting	0 : No operation 01 : Restore factory setting, except motor parameters 02 : Clear records	1	0	×
Pd.02	AC drive parameter display selection	Unit's digit : Group b display selection 0 : Not display 1 : Display Ten's digit: Group E display selection	1	001	×

		0 : Not display 1 : Display			
Pd.03	Individualized parameter display selection	0. Display basic group ; 1. Switchover to user-defined parameter display by press M 2. Switchover to user-modified parameter display by press M	1	0	○
Pd.04	Parameter modification property	0 : Modifiable 1 : Not modifiable	1	0	○

Group PE: Swing Frequency, Fixed Length and Count

Function Code	Parameter Name	Setting Range	Minimum Unit	Default	Property
PE.00	Swing frequency setting mode	0 : Relative to the central frequency 1 : Relative to the maximum frequency	1	0	○
PE.01	Swing frequency amplitude	0.0%~100.0%	0.1%	0.0%	○
PE.02	Jump frequency amplitude	0.0%~50.0%	0.1%	0.0%	○
PE.03	Swing frequency cycle	0.1s~3000.0s	0.1s	10.0s	○
PE.04	Triangular wave rising time coefficient	0.1s~100.0%	0.1%	50.0%	○

PE.05	Set length	0m~65535m	1m	1000m	○
PE.06	Actual length	0m~65535m	1m	0m	○
PE.07	Number of pulse per meter	0.1~6553.5	0.1	100.0	○
PE.08	Set count value	1~65535	1	1000	○
PE.09	Designated count value	1~65535	1	1000	○

Group PF: AIAO Correction and AI Curve Setting

Function Code	Parameter Name	Setting Range	Minimum Unit	Default	Property
PF.00	VI measured voltage 1	0.500V~4.000V	0.001V	2.000V	○
PF.01	VI display voltage1	0.500V~4.000V	0.001V	2.000V	○
PF.02	VI measured voltage 2	6.000V~9.999V	0.001V	8.000V	○
PF.03	VI display voltage 2	6.000V~9.999V	0.001V	8.000V	○
PF.04	CI measured voltage 1	0.500V~4.000V	0.001V	2.000V	○
PF.05	CI display voltage 1	0.500V~4.000V	0.001V	2.000V	○
PF.06	CI measured voltage 2	6.000V~9.999V	0.001V	8.000V	○
PF.07	CI display voltage 2	6.000V~9.999V	0.001V	8.000V	○

PF.12	AO1 target voltage 1	0.500V~4.000V	0.001V	2.000V	○
PF.13	AO1 measured voltage 1	0.500V~4.000V	0.001V	2.000V	○
PF.14	AO1 target voltage 2	6.000V~9.999V	0.001V	8.000V	○
PF.15	AO1 measured voltage 2	6.000V~9.999V	0.001V	8.000V	○
PF.16	AO2 target voltage 1	0.500V~4.000V	0.001V	2.000V	○
PF.17	AO2 measured voltage 1	0.500V~4.000V	0.001V	2.000V	○
PF.18	AO2 target voltage 2	6.000V~9.999V	0.001V	8.000V	○
PF.19	AO2 measured voltage 2	6.000V~9.999V	0.001V	8.000V	○
PF.20	AI curve 4 minimum input	-10.00V~PF.22	0.01V	0.00V	○
PF.21	Corresponding setting of AI curve 4 minimum input	-100.0%~+100.0%	0.001	0.0%	○
PF.22	AI curve 4 inflexion 1 input	PF.20~PF.22	0.01V	3.00V	○
PF.23	Corresponding setting of AI curve 4 inflexion	-100.0%~+100.0%	0.001	30.0%	○

	1 input				
PF.24	AI curve 4 inflexion 2 input	PF.22~PF.26	0.01V	6.00V	○
PF.25	Corresponding setting of AI curve 4 inflexion 2 input	-100.0%~+100.0%	0.001	60.0%	○
PF.26	AI curve 4 maximum input	PF.26~+10.00V	0.01V	10.00V	○
PF.27	Corresponding setting of AI curve 4 maximum input	-100.0%~+100.0%	0.001	100.0%	○
PF.28	AI curve 5 minimum input	-10.00V~PF.10	0.01V	-10.00V	○
PF.29	Corresponding setting of AI curve 5 minimum input	-100.0%~+100.0%	0.001	-100.0%	○
PF.30	AI curve 5 inflexion 1 input	PF.28~PF.32	0.01V	-3.00V	○
PF.31	Corresponding setting of AI curve 5 inflexion 1 input	-100.0%~+100.0%	0.001	-30.0%	○
PF.32	AI curve 5 inflexion 2 input	PF.30~PF.34	0.01V	3.00V	○

PF.33	Corresponding setting of AI curve 5 inflexion 2 input	-100.0%~+100.0%	0.001	30.0%	○
PF.34	AI curve 5 maximum input	PF.32~+10.00V	0.01V	10.00V	○
PF.35	Corresponding setting of AI curve 5 maximum input	-100.0%~+100.0%	0.001	100.0%	○
PF.36	Jump point of VI input corresponding setting	-100.0%~100.0%	0.001	0%	○
PF.37	Jump amplitude of VI input corresponding setting	0.0%~100.0%	0.001	0.5%	○
PF.38	Jump point of CI input corresponding setting	-100.0%~100.0%	0.001	0%	○
PF.39	Jump amplitude of CI input corresponding setting	0.0%~100.0%	0.001	0.5%	○
Group E0 : User-defined Parameters					

Function Code	Parameter Name	Setting Range	Minimum Unit	Default	Property
E0.00	User-defined function code 0	P0.01~PE.xx	-	P0.01	○
E0.01	User-defined function code 1	P0.01~PE.xx	-	P0.02	○
.....	○
E0.06	User-defined function code 6	P0.01~PE.xx	-	P0.18	○
E0.07~ E0.31	User-defined function code 7 ~31	P0.01~PE.xx	-	P0.02	○

Group b: Standard Monitoring Parameters					
Function Code	Parameter Name	Setting Range	Minimum Unit	Default	Property
b0.00	Running frequency (HZ)	0.00Hz~P0.02Hz	0.01Hz	7000H	
b0.01	Setting frequency (HZ)	0.00Hz~P0.02Hz	0.01Hz	7001H	
b0.02	Bus voltage (V)	0.0V~1000.0V	0.1V	7002H	
b0.03	Output voltage (V)	0V~380V	1V	7003H	
b0.04	Output current (A)	0.01A~655.35A	0.01A	7004H	
b0.05	Output power (KW)	0.0kw~1000.0kw	0.1KW	7005H	
b0.06	Output torque (%)	0.0%~200.0%	0.1%	7006H	
b0.07	DI input status	H.0000~H.FFFF	1	7007H	
b0.08	DO output status	H.0000~H.FFFF	1	7008H	

b0.09	V1 voltage (V)	0.00V~10.00V	0.01V	7009H	
b0.10	C1 voltage (V) /current (mA)	0.00V~10.00V	0.01V/0.01mA	700AH	
b0.12	Count value	0~65535	1	700CH	
b0.13	Length value	0~65535	1	700DH	
b0.14	Load speed display	0.00Hz~P0.05Hz	1	700EH	
b0.15	PID setting	0~65535	1	700FH	
b0.16	PID feedback	0.00~300.00kHz	1	7010H	
b0.17	PLC stage	0~65535	1	7011H	
b0.18	Pulse input frequency	0.0Hz~P0.05Hz	0.01kHz	7012H	
b0.19	Feedback speed (HZ)	0.00V~10.00V	0.01Hz	7013H	
b0.20	Remaining running time	0.0~6553.5	0.1Min	7014H	
b0.21	V1 voltage before correction	0.00V~10.00V	0.001V	7015H	
b0.22	C1 voltage /current before correction	0.00V~10.00V	0.001V/0.01m A	7016H	
b0.24	Linear speed	0 m/Min ~65535 m/Min	1m/Min	7018H	
b0.25	Accumulative power- on time	0.0~6553.5	1Min	7019H	
b0.26	Accumulative running time	0.0~6553.5	0.1Min	701AH	
b0.27	Pulse input frequency	0.0~300.0kHz	1Hz	701BH	
b0.28	Communication	0.00~100.00	0.01%	701CH	

	setting value				
b0.29	Encoder feedback speed	0.00Hz~P0.02Hz	0.01Hz	701DH	
b0.30	Main frequency X	0.00Hz~P0.02Hz	0.01Hz	701EH	
b0.31	Auxiliary frequency Y	0V~380V	0.01Hz	701FH	
b0.32	Viewing any register address value	0V~380V	1	7020H	
b0.34	Motor temperature	0.0~6553.5	1°C	7022H	
b0.35	Target torque (%)	0.0~6553.5	0.1%	7023H	
b0.36	Resolver position	0.0~300.0kHz	1	7024H	
b0.37	Power factor angle	0.00~100.00	0.1°	7025H	
b0.38	ABZ position	0.00Hz~P0.02Hz	1	7026H	
b0.39	Target voltage upon V/F separation	0.00Hz~P0.02Hz	1V	7027H	
b0.40	Output voltage upon V/F separation	0V~380V	1V	7028H	
b0.41	DI state visual display	-	1	7029H	
b0.42	DO state visual display	-	1	702AH	
b0.43	DI function state visual display 1	-	1	702BH	
b0.44	DI function state visual display 2	-	1	702CH	

Chapter 6 Description of Function Codes

6.1 Basic Parameters (Group P0)



P0.00	Control Mode	Setting Range : 0~2	0
-------	--------------	---------------------	---



0 : V/F Control : It is applicable to applications with low load requirements or applications where one AC drive operates multiple motors, such as fan and pump.

1 : Sensorless flux vector control (SFVC) : It indicates open-loop vector control, and is applicable to high-performance control applications such as machine tool, centrifuge, wire drawing machine and injection molding machine. One AC drive can operate only one motor.

2 : Closed-loop vector control (CLVC) : It is applicable to high-accuracy speed control or torque control applications such as high-speed paper making machine, crane and elevator. One AC drive can operate only one motor. An encoder must be installed at the motor side, and a PG card matching the encoder must be installed at the AC drive side.

P0.01	Main frequency source 1 selection	Setting Range : 0~9	0
-------	-----------------------------------	---------------------	---

0 : Digital setting (non-retentive at power failure) : You can change the set frequency by pressing  and  on the operation panel. When the AC drive is powered on again after power failure, the set frequency reverts to the value of P0.02 .

1 : Digital setting (retentive at power failure) : You can change the set frequency by pressing keys  and  on the operation panel (or using the UP/DOWN functions of input terminals). When the AC drive is powered on again after power failure, the set frequency is the value memorized at the moment of the last power failure.

2 : VI analog setting (VI-GND). 0–10 V voltage input

3 : CI analog setting (CI-GND). 0–10 V voltage input or 4–20 mA current input, determined

by jumper J8

5 : Pulse setting(PLUSE).The frequency is set by X5 (high-speed pulse). The corresponding relationship of frequency and pulse setting is confirmed by P3.31 to P3.34.

6 : Multi-reference. In multi-reference mode, combinations of different DI terminal states correspond to different set frequencies. The DGI900 supports a maximum of 16 speeds implemented by 16 state combinations of four DI terminals (allocated with functions 12 to 15) in Group Pb. The multiple references indicate percentages of the value of P0.05 (Maximum frequency).If a DI terminal is used for the multi-reference function; you need to perform related setting in group P3.

7 : Simple PLC setting. When the simple programmable logic controller (PLC) mode is used as the frequency source, the running frequency of the AC drive can be switched over among the 16 frequency references. You can set the holding time and acceleration/deceleration time of the 16 frequency references. For details, refer to the descriptions of Group Pb.

8 : PID setting. When applying PID as the frequency source, you need to set parameters of PID function in group P6.

9 : 485 communication.The frequency is set by means of communication. The data is given by the host computer through the communication address 0x1000. The data format is -100.00% to 100.00%. 100.00% corresponds to the value of P0.05 (Maximum frequency).

P0.02	Preset frequency	Setting Range : lower limit to upper limit frequency	50.00Hz
--------------	-------------------------	---	----------------

If the frequency source is digital setting (P0.01 = 0、1) , the value of P0.02 is the initial frequency of the AC drive.

P0.03	Command source selection	Setting Range : 0、1、2	0
--------------	---------------------------------	------------------------------	----------

0 : Operation panel control. Using operation keyboard FWD、STOP/RESET、JOG to startup/stop.

1 : Terminal control. Using external control terminals FWD,REV,X1~X6 to startup/stop.

2 : Communication control. Using RS485 communication protocol to control startup/stop.

P0.04	Rotation direction	Setting Range : 00~11	0
--------------	---------------------------	------------------------------	----------

0 : Same direction.

1 : Reverse direction.

NOTE: The motor will resume running in the original direction after parameter initialization. Do not use this function in applications where changing the rotating direction of the motor is prohibited after system commissioning is complete.

P0.05	Maximum frequency	Setting Range : 50.00Hz~500.0Hz	50.00Hz
--------------	--------------------------	--	----------------

When the frequency source is AI, pulse setting (X5), or multi-reference, 100% of the input corresponds to the value of this parameter.

P0.06	Frequency upper limit	Setting Range : P0.07Hz~P0.05Hz	50.00Hz
--------------	------------------------------	--	----------------

P0.07	Frequency lower limit	Setting Range : 0Hz~P0.06Hz	AC drive dependent
P0.08	Source of frequency upper limit	Setting Range : 0~5	0

It is used to set the source of the frequency upper limit, including 0 : set by P0.02 ; 1 : V1 ; 2 : CI ; 4 : X5 Pulse setting ; 5 : Communication setting. If the frequency upper limit is set by means of analog input, pulse setting or communication, the setting is similar to that of the main frequency source X. For details, see the description of P0.01.

P0.09	Frequency upper limit offset	Setting Range : 0Hz~P0.05	0. 00Hz
--------------	-------------------------------------	----------------------------------	----------------

If the source of the frequency upper limit is analog input or pulse setting, the final frequency upper limit is obtained by adding the offset in this parameter to the frequency upper limit set in P0.08.

P0.10	Carrier frequency	Setting Range : 1.0K~14.0K	AC drive dependent
--------------	--------------------------	-----------------------------------	-------------------------------------

It is used to adjust the carrier frequency of the AC drive, helping to reduce the motor noise, avoiding the resonance of the mechanical system, and reducing the leakage current to the earth and interference generated by the AC drive.

Adjusting the carrier frequency will exert influences on the aspects listed in the following table.

Carrier frequency	lower	higher
Electromagnetic noise	↑	↓

Leakage current	↓	↑
External radiation interference	↓	↑

NOTE:

1. In order to obtain a better control characteristic, carrier frequency and the maximum operation frequency of AC drive ratio less than 36 is not recommended.
2. The current display value will has deviation when the carrier frequency value is too low.

P0.11	Carrier frequency adjustment with temperature	Setting Range : 0~1	0
--------------	--	----------------------------	----------

0 : Not adjust, 1 : Adjust

It is used to set whether the carrier frequency is adjusted based on the temperature. The AC drive automatically reduces the carrier frequency when detecting that the heatsink temperature is high. The AC drive resumes the carrier frequency to the set value when the heatsink temperature becomes normal. This function reduces the overheat alarms.

P0.12	Acceleration time 1	Setting Range : 0.1~6000.0	20.0
P0.13	Deceleration time 1	Setting Range : 0.1~6000.0	20.0

Acceleration time indicates the time required by the AC drive to accelerate from 0 Hz to "Acceleration/Deceleration base frequency" (P0.05), that is, t1 in Figure 6-1.

Deceleration time indicates the time required by the AC drive to decelerate from "Acceleration/Deceleration base frequency" (P0.05) to 0 Hz, that is, t2 in Figure 6-1.

The DGI900 provides totally four groups of acceleration/deceleration time for selection. You

can perform switchover by using a DI terminal.

- Group 1: P0.12~ P0.13
- Group 2: P2.03~ P2.04
- Group 3: P2.05~ P2.06
- Group 4: 2.07~ P2.08

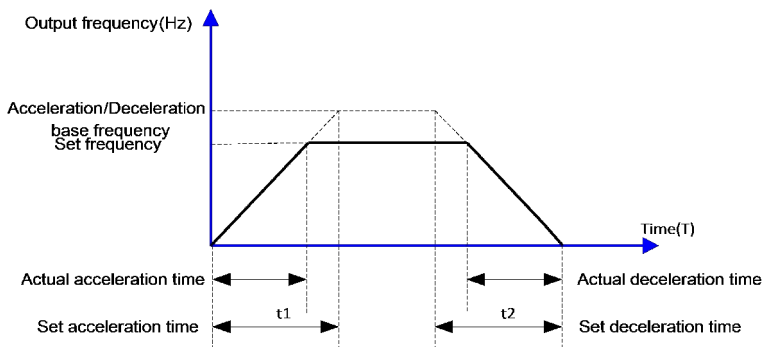

Figure 6-1 Acceleration/Deceleration time

P0.14	Acceleration/ Deceleration time unit	Setting Range : 0~2	0
-------	--------------------------------------	---------------------	---

0: 1s; 1: 0.1s 2: 0.01s

To satisfy requirements of different applications, the DGI900 provides three acceleration/deceleration time units, 1s, 0.1s and 0.01s

NOTE : Modifying this parameter will make the displayed decimal places change and corresponding acceleration/deceleration time also change.

P0.15	Acceleration/ Deceleration	Setting Range : 0~2	0
-------	----------------------------	---------------------	---

	time base frequency		
--	----------------------------	--	--

0 : Maximum frequency (P0.05) ; 1 : Set frequency ; 2 : 100.00Hz

P0.16	Auxiliary frequency source 2 selection	Setting Range : 0~9	0
--------------	---	----------------------------	----------

The same as P0.01(Main frequency source 1 selection)

P0.17	Range of auxiliary frequency 2 for 1 and 2 operation	Setting Range : 0~1	0
--------------	---	----------------------------	----------

0 : Relative to maximum frequency ; 1 : Relative to main frequency 1

P0.18	Range of auxiliary frequency 2 for 1 and 2 operation	Setting Range : 0%~150%	0
--------------	---	------------------------------------	----------

The parameter used for confirming the range of auxiliary frequency

Note : You can set the auxiliary frequency to be relative to either maximum frequency or main frequency 1. If relative to main frequency 1, the setting range of the auxiliary frequency 2 varies according to the main frequency1

P0.19	Frequency source selection	Setting Range : 11~ 00	00
--------------	-----------------------------------	-----------------------------------	-----------

Unit's digit : (Frequency source selection)

0 : Main frequency source 1

1 : 1 and 2 operation (operation relationship determined by ten's digit)

2 : Switchover between 1 and 2,

3 : Switchover between 1 and "1 and 2 operation"

4 : Switchover between 2 and "1 and 2 operation"

Ten's digit (1 and 2 operation relationship)

0 : 1+2

1 : 1-2

2 : Maximum

3 : Minimum

P0.20	Frequency offset of auxiliary frequency source for 1 and 2 operation	Setting Range 0.00Hz~ Maximum frequency	0.00
--------------	---	--	-------------

This parameter is valid only when the frequency source is set to "1 and 2 operation". The final frequency is obtained by adding the frequency offset set in this parameter to the 1 and 2 operation results.

P0.21	Frequency reference resolution	Setting Range : 1 ~2	2
--------------	---------------------------------------	---------------------------------------	----------

1 : 0.1Hz ; 2 : 0.01Hz ;

It is used to set the resolution of all frequency-related parameters.

P0.22	Retentive of digital setting frequency upon power failure	Setting Range : 0~1	0
--------------	--	--------------------------------------	----------

This parameter is valid only when the frequency source is digital setting

0 : "Not retentive" : If P0-22 is set to 0, the digital setting frequency value resumes to the value of P0-02 (Preset frequency) after the AC drive stops. The modification by using keys

▲ and ▼ or the terminal UP/DOWN function is cleared.

1 : “**Retentive**” : If P0-22 is set to 1, the digital setting frequency value is the set frequency at the moment when the AC drive stops. The modification by using keys ▲ and ▼ or the terminal UP/DOWN function remains effective.

P0.23	Base frequency for UP/DOWN modification during running	Setting Range : 0~1	0
--------------	---	--------------------------------------	----------

0 : Running frequency ; **1** : Set frequency.

This parameter is valid only when the frequency source is digital setting.

It is used to set the base frequency to be modified by using keys and or the terminal UP/DOWN function. If the running frequency and set frequency are different, there will be a large difference between the AC drive's performance during the acceleration/deceleration process.

P0.24	Binding command source to frequency source	Setting Range : 0000~ 9999	0000
--------------	---	---	-------------

Unit's digit: Binding operation panel command to frequency source.

Ten's digit: Binding terminal command to frequency source.

Hundred's digit: Binding communication command to frequency source.

Thousand's digit: Binding automatic running command to frequency source

It is used to bind the four running command sources with the nine frequency sources, facilitating to implement synchronous switchover.

For details on the frequency sources, see the description of P0.01 (Main frequency source 1 selection). Different running command sources can be bound to the same frequency source.

If a command source has a bound frequency source, the frequency source set in P0-02, P0.16 and P0.19 no longer takes effect when the command source is effective.

P0.25	G/P type display	Setting Range : 0~1	Model dependent
--------------	-------------------------	----------------------------	------------------------

This parameter is used to display the delivered model and cannot be modified.

1: Applicable to constant torque load with rated parameters specified

2: Applicable to variable torque load (fan and pump) with rated parameters specified

P0.26	Motor parameter group selection	Setting Range : 0~3	0
--------------	--	----------------------------	----------

The DGI900 can drive four motors at different time. You can set the motor nameplate parameters respectively, independent motor auto-tuning, different control modes, and parameters related to running performance respectively for the four motors.

Motor parameter group 1 corresponds to groups P8 and P9. Motor parameter groups 2, 3 and 4 correspond to groups E3, E4 and E5 respectively.

You can select the current motor parameter group by using P0.26 or perform switchover between the motor parameter groups by means of a X terminal. If motor parameters selected by means of P0.26 conflict with those selected by means of X terminal, the selection by X is preferred.

P0.27	Serial communication protocol	Setting Range : 0~0	0
--------------	--------------------------------------	----------------------------	----------

DGI900 supports 0 : MODBUS.

6.2 Start/Stop Control (Group P1)

P1.00	Start mode	Setting Range : 0~2	0
--------------	-------------------	----------------------------	----------

0 : Direct start

- If the DC braking time is set to 0, the AC drive starts to run at the startup frequency.
- If the DC braking time is not 0, the AC drive performs DC braking first and then starts to run at the startup frequency. It is applicable to small-inertia load application where the motor is likely to rotate at startup.

1 : Rotational speed tracking restart

The AC drive judges the rotational speed and direction of the motor first and then starts at the tracked frequency. Such smooth start has no impact on the rotating motor. It is applicable to the restart upon instantaneous power failure of large-inertia load. To ensure the performance of rotational speed tracking restart, set the motor parameters in group P1.11~ P1.12 correctly.

2 : Pre-excited start

It is valid only for asynchronous motor and used for building the magnetic field before the motor runs. For pre-excited current and pre-excited time, see parameters of P1.03 and P1.04.

- If the pre-excited time is 0, the AC drive cancels pre-excitation and starts to run at startup frequency.

– If the pre-excited time is not 0, the AC drive pre-excites first before startup, improving the dynamic response of the motor.

P1.01	Startup frequency	Setting Range : 0.00~ 10.00Hz	0.00
P1.02	Startup frequency holding time	Setting Range : 0.0~100.0s	0.0

To ensure the motor torque at AC drive startup, set a proper startup frequency. In addition, to build excitation when the motor starts up, the startup frequency must be held for a certain period.

NOTE :

The startup frequency (P1.01) is not restricted by the frequency lower limit. If the set target frequency is lower than the startup frequency, the AC drive will not start and stays in the standby state.

During switchover between forward rotation and reverse rotation, the startup frequency holding time is disabled. The holding time is not included in the acceleration time but in the running time of simple PLC.

P1.03	Startup DC braking current/ Pre-excited current	Setting Range: 0%~100%	0
P1.04	Startup DC braking time/ Pre-excited time	Setting Range: 0.0s~100.0s	0.0

Startup DC braking is generally used during restart of the AC drive after the rotating motor stops. Pre-excitation is used to make the AC drive build magnetic field for the asynchronous motor before startup to improve the responsiveness.

Startup DC braking is valid only for direct start (P1.00 = 0). In this case, the AC drive performs DC braking at the set startup DC braking current. After the startup DC braking time, the AC drive starts to run. If the startup DC braking time is 0, the AC drive starts directly without DC braking. The larger the startup DC braking current is, the larger the braking force is.

If the startup mode is pre-excited start (P1.00= 1), the AC drive builds magnetic field based on the set pre-excited current. After the pre-excited time, the AC drive starts to run. If the pre-excited time is 0, the AC drive starts directly without pre-excitation.

NOTE :

The startup DC braking current or pre-excited current is a percentage relative to the base value.

P1.05	Stop mode	Setting Range : 0~1	0
--------------	------------------	----------------------------	----------

0 : Decelerate to stop

After the stop command is enabled, the AC drive decreases the output frequency according to the deceleration time and stops when the frequency decreases to zero.

1 : Coast to stop

After the stop command is enabled, the AC drive immediately stops the output. The motor will coast to stop based on the mechanical inertia.

P1.06	Initial frequency of stop DC braking	Setting Range : 0.00Hz~Maximum frequency	0.00
P1.07	Waiting time of stop DC	Setting Range : 0.0s~	0.0

	braking	100.0s	
P1.08	Stop DC braking time	Setting Range : 0.0s~ 100.0s	0
P1.09	Stop DC braking current	Setting Range : 0%~100%	0.0

P1.06 : During the process of decelerating to stop, the AC drive starts DC braking when the running frequency is lower than the value set in P1.06.

P1.07 : When the running frequency decreases to the initial frequency of stop DC braking, the AC drive stops output for a certain period and then starts DC braking. This prevents faults such as overcurrent caused due to DC braking at high speed.

P1.08 : This parameter specifies the holding time of DC braking. If it is set to 0, DC braking is cancelled.

P1.09 : This parameter specifies the output current at DC braking and is a percentage relative to the base value.

The stop DC braking process is shown in the following figure 6-2.

P1.10	Brake use ratio	Setting Range : 0%~100%	100
--------------	------------------------	--------------------------------	------------

It is valid only for the AC drive with internal braking unit and used to adjust the duty ratio of the braking unit. The larger the value of this parameter is, the better the braking result will be. However, too larger value causes great fluctuation of the AC drive bus voltage during the braking process.

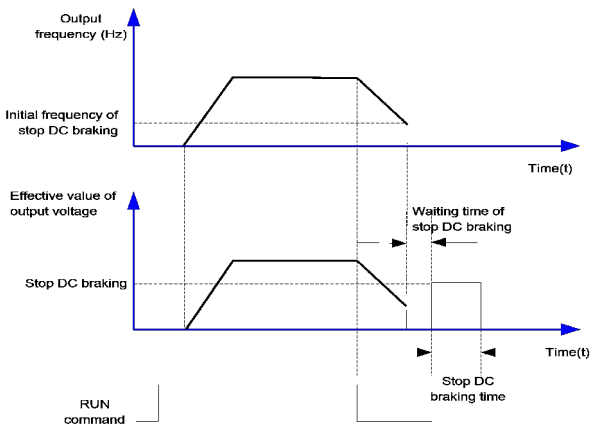

Figure 6-2 Stop DC braking process

P1.11	Rotational speed tracking mode	Setting Range : 0~2	0
-------	--------------------------------	---------------------	---

0 : From frequency at stop - It is the commonly selected mode.

1 : From zero frequency- It is applicable to restart after a long time of power failure.

2 : From the maximum frequency - It is applicable to the power-generating load.

P1.12	Rotational speed tracking speed	Setting Range : 1~100	20
-------	---------------------------------	-----------------------	----

In the rotational speed tracking restart mode, select the rotational speed tracking speed. The larger the value is, the faster the tracking is. However, too large value may cause unreliable tracking.

P1.13	Acceleration/Deceleration mode	Setting Range : 0, 1	0
-------	--------------------------------	----------------------	---

0: Linear acceleration/deceleration. The output frequency increases or decreases in linear mode, showing in figure 6-3.

1: S-curve acceleration/deceleration. The output frequency increases or decreases along the S curve, showing in figure 6-4.

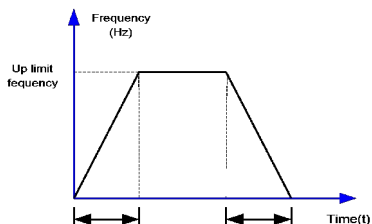

Figure 6-3

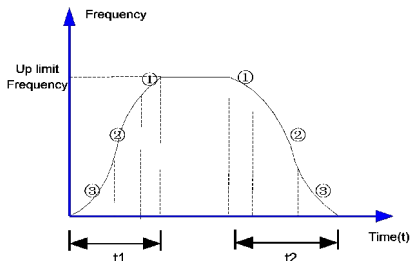

Figure 6-4

P1.14	Time proportion of S-curve start segment	Setting Range : 10.0%~50.0% (acceleration/deceleration time) , P0.14 + P0.15<90%	30.0%
P1.15	Time proportion of S-curve end segment	Setting Range : 10.0%~80.0% (acceleration/deceleration time) , P0.14 + P0.15<90%	30.0%

These two parameters respectively define the time proportions of the start segment and the end segment of S-curve acceleration/deceleration. They must satisfy the requirement: $P1.14+P1.15 \leq 90.0\%$.

In Figure 6-4, ③ is the time defined in P1.14, within which the slope of the output frequency change increases gradually. ① is the time defined in P1.15, within which the slope of the output frequency change gradually decreases to 0. Within the time between ① and ③, the slope of the output frequency change remains unchanged, that is, linear acceleration/

deceleration.

NOTE :

S-curve acceleration/deceleration suitable for startup/stop of elevator, conveyor, etc.

6.3 Auxiliary Functions (Group P2)

P2.00	JOG running frequency	Setting Range : 0.10~50.00Hz	5.00Hz
P2.01	JOG acceleration time	Setting Range : 0.1~60.0S	20.0S
P2.02	JOG deceleration time	Setting Range : 0.1~60.0S	20.0S

JOG acceleration time means the running time of AC drive from 0Hz to upper limit frequency.

JOG deceleration time means the running time of AC drive from upper limit frequency to 0Hz.

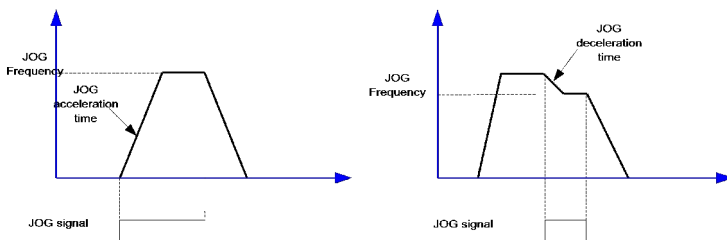

Figure 6-5 JOG operation

P2.03	Acceleration time 2	Setting Range : 0.1~6000.0	20.0
P2.04	Deceleration time 2	Setting Range : 0.1~6000.0	20.0
P2.05	Acceleration time 3	Setting Range : 0.1~6000.0	20.0
P2.06	Deceleration time 3	Setting Range : 0.1~6000.0	20.0

P2.07	Acceleration time 4	Setting Range : 0.1~6000.0	20.0
P2.08	Deceleration time 4	Setting Range : 0.1~6000.0	20.0

The DGI900 provides a total of four groups of acceleration/deceleration time, and you can switch over between the four groups of acceleration/deceleration time through different state combinations of terminals. For more details, see the descriptions of P3.00~P3.09.

P2.09	Jump frequency 1	Setting Range : 0.00 – 500.00Hz	0.00Hz
P2.10	Jump frequency 2	Setting Range : 0.00 – 500.00Hz	0.00Hz
P2.11	Jump frequency amplitude	Setting Range : 0.00 – 30.00Hz	0.00Hz

If the set frequency is within the frequency jump range, the actual running frequency is the jump frequency close to the set frequency. Setting the jump frequency helps to avoid the mechanical resonance point of the load.

The DGI900 supports two jump frequencies. If both are set to 0, the frequency jump function is disabled. The principle of the jump frequencies and jump amplitude is shown in the following figure 6-6.

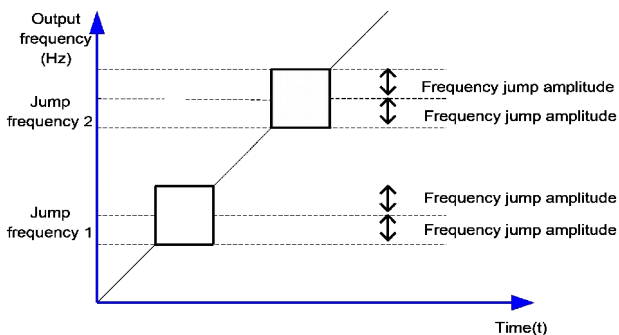

Figure 6-6 Principle of the jump frequencies and jump amplitude

P2.12	Forward/Reverse rotation dead-zone time	Setting Range : 0.0~ 120.0s	0.0s
--------------	--	--	-------------

It is used to set the time when the output is 0 Hz at transition of the AC drive forward rotation and reverse rotation, as t1 shown in the following figure 6-7. t1.

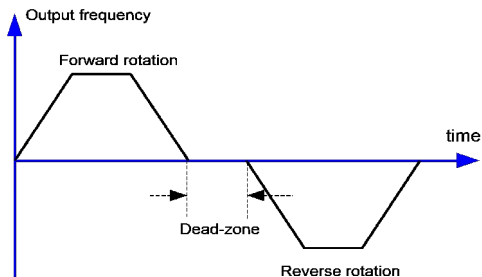

Figure 6-7 Forward/Reverse rotation dead-zone time

P2.13	Reverse control	Setting Range : 0~1	0
--------------	------------------------	----------------------------	----------

It is used to set whether the AC drive allows reverse rotation. In the applications where reverse rotation is prohibited, set this parameter to 1.

P2.14	Running mode when set frequency lower than frequency lower limit	Setting Range : 0~2	0
--------------	---	----------------------------	----------

0 : Run at frequency lower limit ; **1** : Stop ; **2** : Run at zero speed

It is used to set the AC drive running mode when the set frequency is lower than the frequency lower limit. The DGI900 provides three running modes to satisfy requirements of various applications

P2.15	Drop control	Setting Range : 0.00Hz~ 10.00Hz	0
--------------	---------------------	--	----------

This function is used for balancing the workload allocation when multiple motors are used to drive the same load. The output frequency of the AC drives decreases as the load increases.

You can reduce the workload of the motor under load by decreasing the output frequency for this motor, implementing workload balancing between multiple motors.

P2.16	Accumulative power-on time threshold	Setting Range : 0h~65000h	0
--------------	---	--------------------------------------	----------

If the accumulative power-on time (P7.12) reaches the value set in this parameter, the corresponding DO terminal becomes ON.

P2.17	Accumulative running time threshold	Setting Range : 0h~65000h	0
--------------	--	--------------------------------------	----------

It is used to set the accumulative running time threshold of the AC drive. If the accumulative running time (P7.08) reaches the value set in this parameter, the corresponding DO terminal becomes ON.

P2.18	Startup protection	Setting Range : 0~1	0
--------------	---------------------------	----------------------------	----------

0 : NO ; 1 : YES

This parameter is used to set whether to enable the safety protection. If it is set to 1, the AC drive does not respond to the run command valid upon AC drive power-on (for example, an input terminal is ON before power-on). The AC drive responds only after the run command is cancelled and becomes valid again.

In addition, the AC drive does not respond to the run command valid upon fault reset of the AC drive. The run protection can be disabled only after the run command is cancelled.

In this way, the motor can be protected from responding to run commands upon power-on or fault reset in unexpected conditions.

P2.19	Frequency detection value (FDT1)	Setting Range : 0.00Hz~ Maximum frequency	50.00Hz
P2.20	Frequency detection hysteresis (FDT1)	Setting Range : 0.0%~100.0%	0.5%

If the running frequency is higher than the value of P2.19, the corresponding DO terminal becomes ON. If the running frequency is lower than value of P2.19, the DO terminal goes OFF.

These two parameters are respectively used to set the detection value of output frequency and hysteresis value upon cancellation of the output. The value of P2.20 is a percentage of the hysteresis frequency to the frequency detection value (P2.19).

The FDT function is shown in the following figure 6-8.

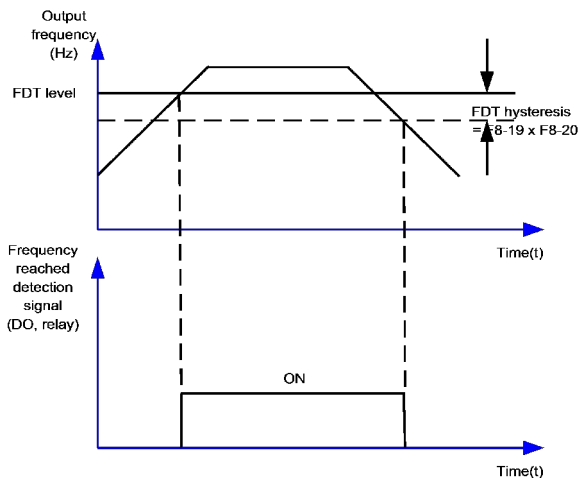

P2.21	Detection range of frequency reached	Setting Range : 0.00~100% (maximum frequency)	0.0%
--------------	---	--	-------------

If the AC drive running frequency is within the certain range of the set frequency, the corresponding DO terminal becomes ON.

This parameter is used to set the range within which the output frequency is detected to reach the set frequency. The value of this parameter is a percentage relative to the maximum frequency. The detection range of frequency reached is shown in the following figure 6-9.

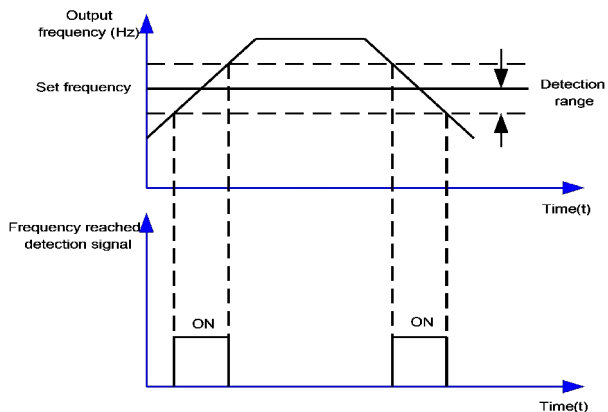

Figure 6-9 Detection range of frequency reached

P2.22	Jump frequency during acceleration /deceleration	Setting Range : 0~1	0
-------	---	-------------------------------	----------

0 : Disabled ; 1 : Enabled

It is used to set whether the jump frequencies are valid during acceleration/deceleration.

When the jump frequencies are valid during acceleration/deceleration, and the running frequency is within the frequency jump range, the actual running frequency will jump over the set frequency jump amplitude (rise directly from the lowest jump frequency to the highest jump frequency). The following figure 6-10 shows the diagram when the jump frequencies are valid during acceleration/deceleration.

DGI900 provides two group parameters of any frequency reaching detection, setting frequency value and frequency reaching detection range respectively, shown in the figure 6-11.

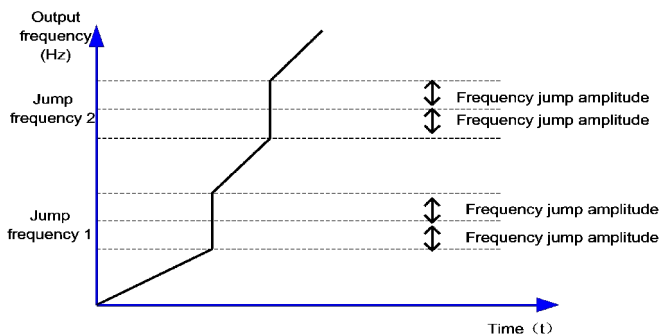

Figure 6-10 Diagram when the jump frequencies are valid during acceleration/deceleration

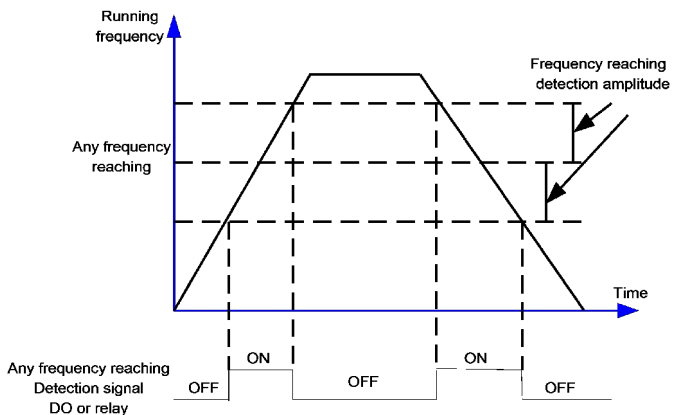

Figure 6-11 Diagram of any frequency reaching detection

P2.23	Frequency switchover point between acceleration time 1 and acceleration time 2	Setting Range : 0.00Hz~ maximum frequency	0.00Hz
P2.24	Frequency switchover point between deceleration time 1 and deceleration time 2	Setting Range : 0.00Hz~ maximum frequency	0.00Hz

This function is valid when motor 1 is selected and acceleration/deceleration time switchover is not performed by means of DI terminal. It is used to select different groups of acceleration/deceleration time based on the running frequency range rather than DI terminal during the running process of the AC drive.

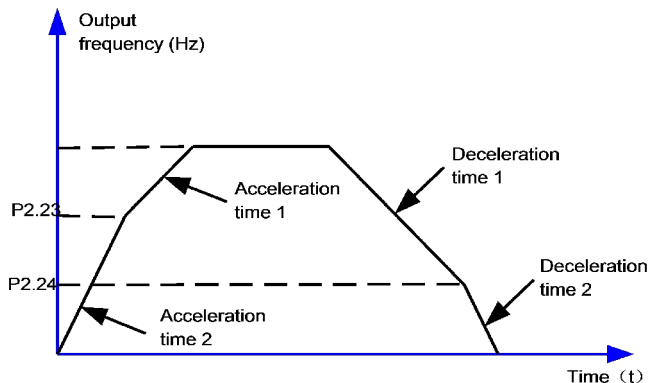

Figure 6-12 Acceleration/deceleration time switchover

During acceleration, if the running frequency is smaller than the value of P2.23, acceleration time 2 is selected. If the running frequency is larger than the value of P2.23, acceleration time 1 is selected.

During deceleration, if the running frequency is larger than the value of P2.24, deceleration time 1 is selected. If the running frequency is smaller than the value of P2.24, deceleration time 2 is selected.

P2.25	Terminal JOG preferred	Setting Range : 0~1	0
--------------	-------------------------------	----------------------------	----------

0 : Disabled ; 1 : Enabled

If terminal JOG is preferred, the AC drive switches to terminal JOG running state when there is a terminal JOG command during the running process of the AC drive.

P2.26	Frequency detection value (FDT2)	Setting Range : 0.00Hz~ maximum frequency	50.00Hz
P2.27	Frequency detection hysteresis (FDT2)	0.0%~100.0%	0.5%

The frequency detection function is the same as FDT1 function. For details, refer to the descriptions of P2.20 and P2.21.

P2.28	Any frequency reaching detection value 1	Setting Range : 0.00Hz~ maximum frequency	0.00Hz
P2.29	Any frequency reaching detection amplitude 1	Setting Range : 0.0%~100.0%	0.0%
P2.30	Any frequency reaching detection value 2	Setting Range : 0.00Hz~ maximum frequency	50.00Hz
P2.31	Any frequency reaching detection amplitude 2	Setting Range : 0.0%~100.0%	0.0%

If the output frequency of the AC drive is within the positive and negative amplitudes of the any frequency reaching detection value, the corresponding DO becomes ON.

P2.32	Zero current detection level	Setting Range : 0.0%~300.0%	5.0%
P2.33	Zero current detection delay time	Setting Range : 0.01s~600.00s	0.10s

If the output current of the AC drive is equal to or less than the zero current detection level

and the duration exceeds the zero current detection delay time, the corresponding DO becomes ON. The zero current detection is shown in the following figure 6-13.

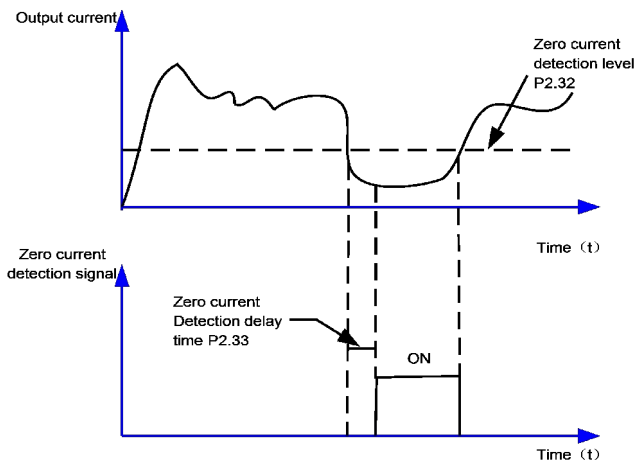

Figure 6-13 Zero current detection

P2.34	Output overcurrent threshold	Setting Range : 0.0%~300.0%	5.0%
P2.35	Output overcurrent detection delay time	Setting Range : 0.01s~600.00s	0.10s

If P2.34 is 0.0%, no detection; 0.1%~300%(rated motor current)

If the output current of the AC drive is equal to or higher than the overcurrent threshold and the duration exceeds the detection delay time, the corresponding DO becomes ON. The output overcurrent detection function is shown in the following figure6-14.

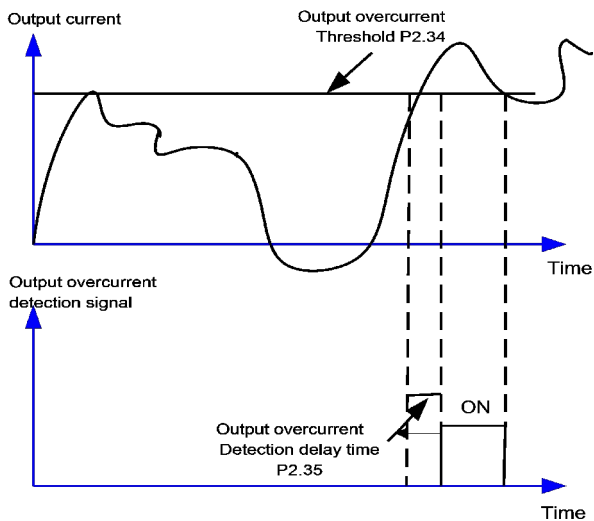

Figure 6-14 Output over current detection

P2.36	Any current reaching 1	Setting Range : 0.0%~300.0% (rated motor current)	100.0%
P2.37	Any current reaching 1 amplitude	Setting Range : 0.0%~300.0% (rated motor current)	0.0%
P2.38	Any current reaching 2	Setting Range : 0.0%~300.0% (rated motor current)	100.0%
P2.39	Any current reaching 2 amplitude	Setting Range : 0.0%~300.0% (rated motor current)	0.0%

If the output current of the AC drive is within the positive and negative amplitudes of any current reaching detection value, the corresponding DO becomes ON.

The DGI900 provides two groups of any current reaching detection parameters, including current detection value and detection amplitudes, as shown in the following figure6-15.

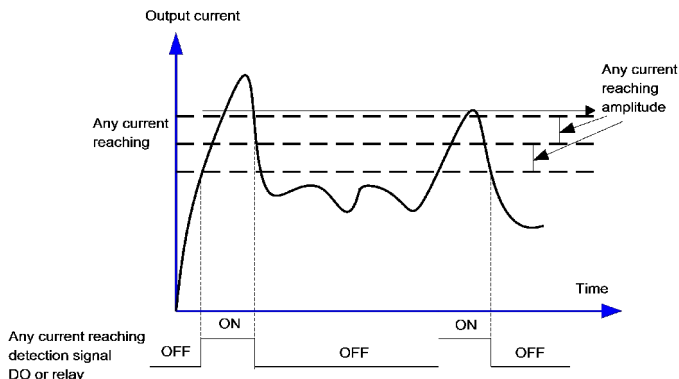

Figure 6-15 Any current reaching detection

P2.40	Timing function	Setting Range : 0~1	0
P2.41	Timing duration selection	Setting Range : 0~3	2.0%
P2.42	Timing duration	Setting Range : 0.0Min~6500.0Min	0Min

These parameters are used to implement the AC drive timing function.

If P2.40 is set to 1, the AC drive starts to time at startup. When the set timing duration is reached, the AC drive stops automatically and meanwhile the corresponding DO becomes ON.

The AC drive starts timing from 0 each time it starts up and the remaining timing duration

can be queried by b0.25.

The timing duration is set in P2.41 and P2.42, in unit of minute. P2.41 Timing duration selection :

0 : P2.41 setting ; 1 : VI ; 2 : CI ; ;

P2.43	VI input voltage lower limit	Setting Range : 0.00V~P2.44	3.1V
P2.44	VI input voltage upper limit	Setting Range : P2.43~10.00V	6.8V

These two parameters are used to set the limits of the input voltage to provide protection on the AC drive. When the AI1 input is larger than the value of P2.43 or smaller than the value of P2.44, the corresponding DO becomes ON, indicating that AI1 input exceeds the limit.

P2.45	Module temperature threshold	Setting Range : 0°C~ 100°C	75°C
--------------	-------------------------------------	---	-------------

When the heatsink temperature of the AC drive reaches the value of this parameter, the corresponding DO becomes ON, indicating that the module temperature reaches the threshold.

P2.46	Cooling fan control	Setting Range : 0~1	0
--------------	----------------------------	----------------------------	----------

It is used to set the working mode of the cooling fan. If this parameter is set to 0, the fan works when the AC drive is in running state. When the AC drive stops, the cooling fan works if the heatsink temperature is higher than 40°C, and stops working if the heatsink

temperature is lower than 40°C.

If this parameter is set to 1, the cooling fan keeps working after power-on.

P2.47	Wakeup frequency	Setting Range : Dormant frequency (P2.49) ~P0.05	0.00Hz
P2.48	Wakeup delay time	Setting Range : 0.0s~6500.0s	0.0s
P2.49	Dormant frequency	Setting Range : 0.00Hz~Wakeup frequency (P2.47)	0
P2.50	Dormant delay time	Setting Range : 0.0s~6500.0s	0.0s

These parameters are used to implement the dormant and wakeup functions in the water supply application.

When the AC drive is in running state, the AC drive enters the dormant state and stops automatically after the dormant delay time (P2.50) if the set frequency is lower than or equal to the dormant frequency (P2.49).

When the AC drive is in dormant state and the current running command is effective, the AC drives starts up after the wakeup delay time (P2.48) if the set frequency is higher than or equal to the wakeup frequency (P2.47).

Generally, set the wakeup frequency equal to or higher than the dormant frequency. If the wakeup frequency and dormant frequency are set to 0, the dormant and wakeup functions

are disabled.

When the dormant function is enabled, if the frequency source is PID, whether PID operation is performed in the dormant state is determined by P6.28. In this case, select PID operation enabled in the stop state (P6.28 = 1).

P2.51	Current running time reached	Setting Range : 0.0s~6500.0s	0.0s
--------------	-------------------------------------	---	-------------

If the current running time reaches the value set in this parameter, the corresponding DO becomes ON, indicating that the current running time is reached.

6.4 Input Terminals (Group P3)

P3.00	X1 function selection	Setting range : 0~50	1
P3.01	X2 function selection	Setting range : 0~50	2
P3.02	X3 function selection	Setting range : 0~50	9
P3.03	X4 function selection	Setting range : 0~50	12
P3.04	X5 function selection	Setting range : 0~50	13
P3.05	X6 function selection	Setting range : 0~50	0
P3.06	X7 function selection	Setting range : 0~50	0
P3.07	X8 function selection	Setting range : 0~50	0
P3.08	X9 function selection	Setting range : 0~50	0
P3.09	X10 function selection	Setting range : 0~50	0

Terminal X1~X10 provide rich functions, user can select it as required by set P3.00 to P3.09. For details, see following table 6-1, and X1 to terminal FWD, X2 to terminal REV.

Table 6-1 Functions of XI terminals

Value	Function	Value	Function
0	No function	1	Forward RUN (FWD)
2	Reverse RUN (REV)	3	Three-line control
4	Forward JOG (FJOG)	5	Reverse JOG (RJOG)
6	Terminal UP	7	Terminal DOWN
8	Coast to stop (FRS)	9	Fault reset
10	RUN pause	11	Normally open(NO) input of external
12	Multit-reference terminal 1	13	Multit-reference terminal 2
14	Multit-reference terminal 3	15	Multit-reference terminal 4
16	Terminal 1 for acceleration /deceleration time selection	17	Terminal 2 for acceleration /deceleration time selection
18	Frequency source switchover	19	UP/DOWN setting clear (terminal, operation panel)
20	Command source switchover	21	Acceleration/Deceleration prohibited
22	PID pause	23	PLC status reset
24	Swing pause	25	Counter input DI5
26	Counter reset	27	Length count input
28	Length reset	29	Reserved
30	Reserved	31	Reserved
32	Immediate DC braking	33	Normally closed(NC)input of external fault
34	Frequency modification forbidden	35	Reverse PID action direction
36	External STOP terminal 1	37	Command source switchover terminal 2
38	PID integral pause	39	Switchover between main frequency source X and preset frequency
40	Switchover between main frequency source Y and	41	Reserved

42	Reserved	43	PID parameter switchover
44	User-defined fault 1	45	User-defined fault 2
46	Reserved	47	Reserved
48	External STOP terminal 2	49	Deceleration DC braking
50	Clear the current running time		

Description of the functions shown in table 6-1 :

1~2 : Forward/Reverse terminals

The terminal is used to control forward or reverse RUN of the AC drive.

3: Three-line control

The terminal determines three-line control of the AC drive. For details, see the description of P3.14.

4~5: Forward/Reverse JOG

FJOG indicates forward JOG running, while RJOG indicates reverse JOG running. The JOG frequency, acceleration time and deceleration time are described respectively in P2.00, P2.01 and P2.02.

6~7 : Terminal UP/ Terminal DOWN

If the frequency is determined by external terminals, the terminals with the two functions are used as increment and decrement commands for frequency modification. When the frequency source is digital setting, they are used to adjust the frequency. The change rate of terminal UP/DOWN per second is set by P3.15.

8 : Coast to stop

The AC drive blocks its output, the motor coasts to rest and is not controlled by the AC drive.

It is the same as coast to stop described in P1.05.

9 : Fault reset (RESET)

The terminal is used for fault reset function, the same as the function of RESET key on the operation panel. Remote fault reset is implemented by this function.

10 : RUN pause

The AC drive decelerates to stop, but the running parameters are all memorized, such as PLC, swing frequency and PID parameters. After this function is disabled, the AC drive resumes its status before stop.

11 : Normally open (NO) input of external fault

If this terminal becomes ON, the AC drive reports E-13 and performs the fault protection action. The fault signal has two input mode: normally open and normally close.

As you see in figure 6-17, X4 is normally open input, and KM is external fault relay.

12~15 : Multi-reference terminal

The four multi-reference terminals have 16 state combinations, corresponding to 16 reference values, as listed in the following table.

K4	K3	K2	K1	Reference Setting	Corresponding Parameter
OFF	OFF	OFF	OFF	Reference 0	Pb.00
OFF	OFF	OFF	ON	Reference 1	Pb.01
OFF	OFF	ON	OFF	Reference 2	Pb.02
OFF	OFF	ON	ON	Reference 3	Pb.03
OFF	ON	OFF	OFF	Reference 4	Pb.04

OFF	ON	OFF	ON	Reference 5	Pb.05
OFF	ON	ON	OFF	Reference 6	Pb.06
OFF	ON	ON	ON	Reference 7	Pb.07
ON	OFF	OFF	OFF	Reference 8	Pb.08
ON	OFF	OFF	ON	Reference 9	Pb.09
ON	OFF	ON	OFF	Reference 10	Pb.10
ON	OFF	ON	ON	Reference 11	Pb.11
ON	ON	OFF	OFF	Reference 12	Pb.12
ON	ON	OFF	ON	Reference 13	Pb.13
ON	ON	ON	OFF	Reference 14	Pb.14
ON	ON	ON	ON	Reference 15	Pb.15

If the frequency source is multi-reference, the value 100% of Pb.00 to Pb.15 corresponds to the value of P0.05 (Maximum frequency).

Besides the multi-speed function, the multi-reference can be also used as the PID setting source or the voltage source for V/F separation, satisfying the requirement on switchover of different setting values.

Figure 6-16 multi-reference wiring diagrams

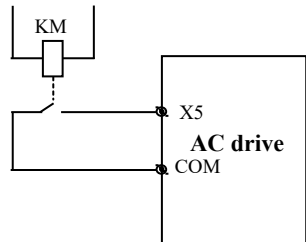
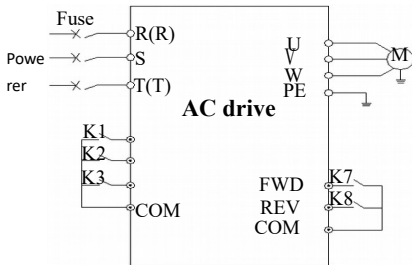

Figure 6-17 External fault input diagram

16~17 : Acceleration/Deceleration time selection

Two terminals for acceleration/deceleration time selection have four state combinations, as listed in the following table.

Terminal 2	Terminal 1	Acceleration/Deceleration time selection
OFF	OFF	Acceleration time 1/ Deceleration time 1
OFF	ON	Acceleration time 2/ Deceleration time 2
ON	OFF	Acceleration time 3/ Deceleration time 3
ON	ON	Acceleration time 4/ Deceleration time 4

Table 6-2 Acceleration/Deceleration time selection

18 : Frequency source switchover

The terminal is used to perform switchover between two frequency sources according to the setting in P0.19.

19 : UP and DOWN setting clear (terminal, operation panel)

If the frequency source is digital setting, the terminal is used to clear the modification by using the UP/DOWN function or the UP/DOWN key on the operation panel, returning the set frequency to the value of P0.02.

20 : Command source switchover terminal

If the command source is set to terminal control (P0.03=1), this terminal is used to perform switchover between terminal control and operation panel control.

If the command source is set to communication control (P0.03=2), this terminal is used to perform switchover between communication control and operation panel control.

21 : Acceleration/Deceleration prohibited

It enables the AC drive to maintain the current frequency output without being affected by external signals (except the STOP command).

22 : PID pause

PID is invalid temporarily. The AC drive maintains the current frequency output without supporting PID adjustment of frequency source.

23 : PLC status reset

The terminal is used to restore the original status of PLC control for the AC drive when PLC control is started again after a pause.

24 : Swing pause

The AC drive outputs the central frequency, and the swing frequency function pauses.

25 : Counter input

This terminal is used to count pulses.

26 : Counter reset

This terminal is used to clear the counter status.

27 : Length count input

This terminal is used to count the length, for details, see PE.05 and PE.06 description.

28 : Length reset

This terminal is used to clear the length (PE.06).

32 : Immediate DC braking

After this terminal becomes ON, the AC drive directly switches over to the DC braking state.

33 : Normally closed (NC) input of external fault

34 : Frequency modification forbidden

After this terminal becomes ON, the AC drive does not respond to any frequency modification.

35 : Reverse PID action direction

After this terminal becomes ON, the PID action direction is reversed to the direction set in P6.03.

36 : External STOP terminal 1

In operation panel mode, this terminal can be used to stop the AC drive, equivalent to the function of the STOP key on the operation panel.

37 : Command source switchover terminal 2

It is used to perform switchover between terminal control and communication control. If the command source is terminal control, the system will switch over to communication control after this terminal becomes ON.

38 : PID integral pause

After this terminal becomes ON, the integral adjustment function pauses. However, the proportional and differentiation adjustment functions are still valid.

39 : Switchover between main frequency source X and preset frequency

After this terminal becomes ON, the frequency source X is replaced by the preset frequency set in P0.02.

40 : Switchover between auxiliary frequency source Y and preset frequency

After this terminal is enabled, the frequency source Y is replaced by the preset frequency set in P0.02.

43 : PID parameter switchover

If the PID parameters switchover performed by means of DI terminal (P6.18 = 1), the PID parameters are P6.05 to P6.07 when the terminal becomes OFF; the PID parameters are P6.15 to P6.17 when this terminal becomes ON.

44~45 : User-defined fault 1,2

If these two terminals become ON, the AC drive reports E-32 and E-33 respectively, and performs fault protection actions based on the setting in PA.46.

47 : Emergency stop

When this terminal becomes ON, the AC drive stops within the shortest time. During the stop process, the current remains at the set current upper limit. This function is used to satisfy the requirement of stopping the AC drive in emergency state.

48 : External STOP terminal 2

In any control mode (operation panel, terminal or communication), it can be used to make the AC drive decelerate to stop. In this case, the deceleration time is deceleration time 4.

49 : Deceleration DC braking

When this terminal becomes ON, the AC drive decelerates to the initial frequency of stop DC braking and then switches over to DC braking state.

50 : Clear the current running time

When this terminal becomes ON, the AC drive's current running time is cleared. This function must be supported by P2.40 and P2.41.

P3.10	VI function selection(DI)	Setting Range : 0~50	0
P3.11	CI function selection(DI)	Setting Range : 0~50	0

The functions of these parameters are to use AI as DI. When AI is used as DI, the AI state is high level if the AI input voltage is 7 V or higher and is low level if the AI input voltage is 3V or lower. The AI state is hysteresis if the AI input voltage is between 3 V and 7 V. A1-10 is used to determine whether high level valid or low level valid when AI is used as DI. See the following figure 6-18.

The setting of AIs (used as DI) function is the same as that of Xs. For details, see the descriptions of group P3.

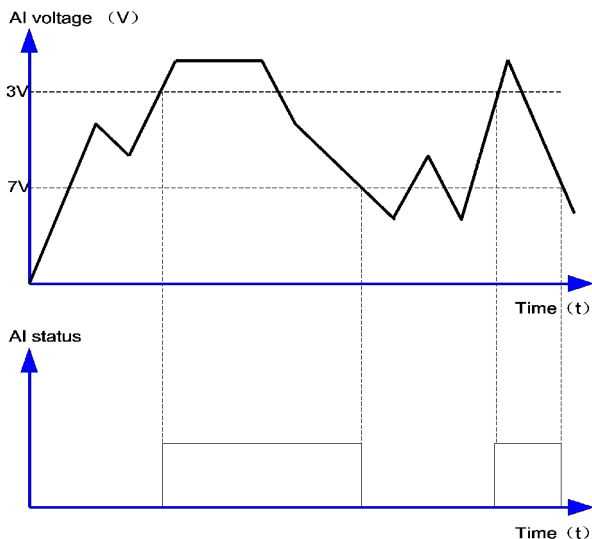

Figure6-18 Relationship of AI input voltage and corresponding DI status

P3.13	X filter time	Setting Range : 0.000s~1.000s	0.010s
--------------	----------------------	--	---------------

It is used to set the software filter time of X terminal status. If DI terminals are liable to interference and may cause malfunction, increase the value of this parameter to enhance the anti-interference capability. However, increase of X filter time will reduce the response of X terminals.

P3.14	Terminal command mode	Setting Range : 0~3	0
--------------	------------------------------	----------------------------	----------

This parameter is used to set the mode in which the AC drive is controlled by external terminals in four modes.

0 : Two-line mode 1

K2K1RUN
Command00Stop01Forward
RUN10Reverse RUN11Stop

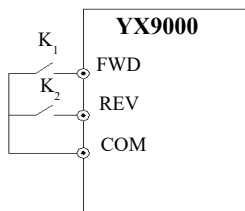

Figure 6-19 Two-line mode 1

1 : Two-line mode 2

K2K1RUN
Command00Stop10Stop01Forward
RUN11Reverse RUN

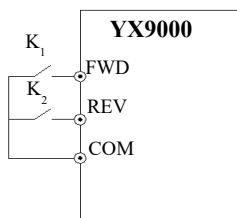

Figure 6-20 Two-line mode 2

2 : Three-line mode 1

SB1 : Stop button

SB2 : Forward button

SB3: Reverse button

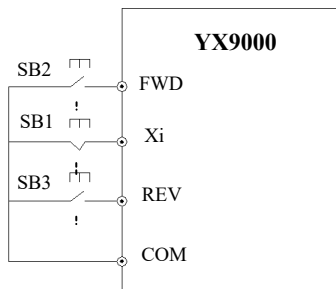

Figure 6-21 Three-line mode 1

3 : Three-line mode 2

SB1 : Stop button

SB2 : Run button

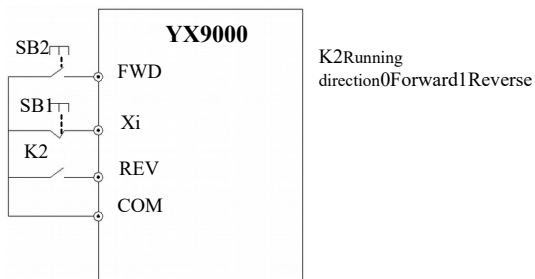

Figure 6-22 Three-line mode 2

NOTE : When alarm to stop, if running command model chose terminals valid and FWD/REV is in valid status, reset the fault, the AC drive will start at once.

P3.15	Terminal UP/DOWN rate	Setting Range : 0.001Hz ~65.535	1.000Hz
--------------	------------------------------	--	----------------

It is used to adjust the rate of change of frequency when the frequency is adjusted by means of terminal UP/DOWN.

P3.16	VI curve 1 minimum input	Setting Range : 0.00v~P3.18	0.00V
P3.17	Corresponding setting of VI curve 1 minimum input	Setting Range : -100.0%~+100.0%	0.0%
P3.18	VI curve 1 maximum input	Setting Range :	10.00v

		P3.16~+10.00v	
P3.19	Corresponding setting of VI curve 1 maximum input	Setting Range : -100.0%~+100.0%	100.0%
P3.20	VI filter time	Setting Range : 0.00s~10.00s	0.10s
P3.21	CI curve 1 minimum input	Setting Range : 0.00v~P3.23	0.00V
P3.22	Corresponding setting of CI curve 1 minimum input	Setting Range : -100.0%~+100.0%	0.0%
P3.23	CI curve 1 maximum input	Setting Range : P3.21~+10.00v	10.00v
P3.24	Corresponding setting of CI curve 1 maximum input	Setting Range : -100.0%~+100.0%	100.0%
P3.25	CI filter time	Setting Range : 0.00s~10.00s	0.10s
P3.31	Pulse minimum input	Setting Range : 0.00kHz~P3.33	0.00kHz
P3.32	Corresponding setting of pulse minimum input	Setting Range : -100.0%~+100.0%	0.0%
P3.33	Pulse maximum input	Setting Range : P3.31~100.00kHz	0.00kHz
P3.34	Corresponding setting of pulse maximum input	Setting Range : -100.0%~+100.0%	0.0%
P3.35	Pulse filter time	Setting Range : 0.00s~10.00s	0.10s

These parameters are used to define the relationship between the analog input voltage and the corresponding setting.

When the analog input voltage exceeds the maximum value (P3.18), the maximum value is used. When the analog input voltage is less than the minimum value (P8.16), the value set in P3.36 (Setting for AI less than minimum input) is used.

When the analog input is current input, 1 mA current corresponds to 0.5 V voltage.

P3.20 (VI1 filter time) is used to set the software filter time of VI1. If the analog input is liable to interference, increase the value of this parameter to stabilize the detected analog input.

However, increase of the VI filter time will slow the response of analog detection. Set this parameter properly based on actual conditions.

In different applications, 100% of analog input corresponds to different nominal values. For details, refer to the description of different applications.

Two typical setting examples are shown in the following figure

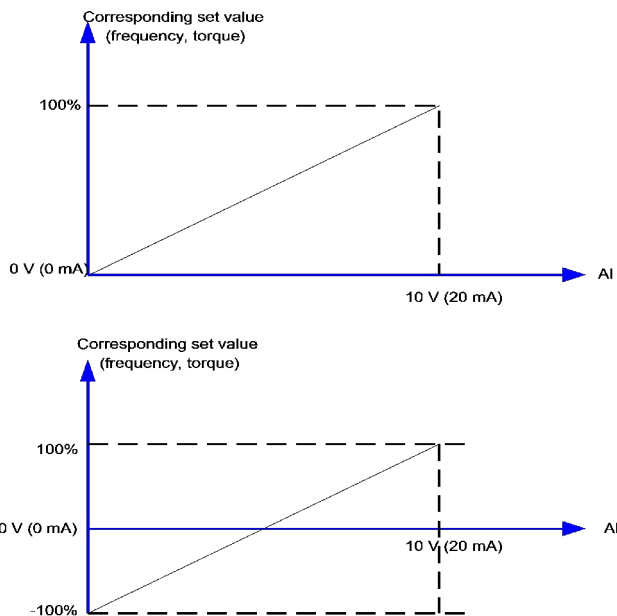

Figure 6-23 Corresponding relationship between analog input and set values

P3.36	VI curve selection	Setting Range : 333~ 000	321
--------------	---------------------------	-------------------------------------	------------

The unit's digit, ten's digit and hundred's digit of this parameter are respectively used to select the corresponding curve of VI and CI. Any of the five curves can be selected for VI and CI.

Curve 1, curve 2 and curve 3 are all 2-point curves, set in group P3. Curve 1 corresponding to P3.16 to P3.20, Curve 2

corresponding to P3.21 to P3.25, Curve 3 corresponding to P3.26 to P3.30.

P3.37	Setting for VI less than minimum input	Setting Range : 333~000	321
--------------	---	--------------------------------	------------

This parameter is used to determine the corresponding setting when the analog input voltage is less than the minimum value. The unit's digit, ten's digit and hundred's digit of this parameter respectively correspond to the setting for VI and CI.

If the value of a certain digit is 0, when analog input voltage is less than the minimum input, the corresponding setting of the minimum input (P3.16、P3.22、P3.26) is used.

If the value of a certain digit is 1, when analog input voltage is less than the minimum input, the corresponding value of this analog input is 0.0%.

P3.38	X1 delay time	Setting Range : 0.0s~3600.0s	0.0s
P3.39	X2 delay time	Setting Range : 0.0s~3600.0s	0.0s
P3.40	X3 delay time	Setting Range : 0.0s~3600.0s	0.0s

These parameters are used to set the delay time of the AC drive when the status of X terminals changes.

Currently, only X1, X2 and X3 support the delay time function.

P3.41	X valid mode Selection 1	Setting Range : 00000~11111	00000
--------------	---------------------------------	------------------------------------	--------------

P3.42	X valid mode Selection 2	Setting Range : 00000~11111	00000
P3.43	AI as valid status selection of X	Setting Range : 000~ 111	000

0 : High level valid, 1 : Low level valid.

These parameters are used to set the valid mode of X terminals.

The X terminal is valid when being connected with COM, and invalid when being disconnected from COM.

The X terminal is invalid when being connected with COM, and invalid when being disconnected from COM.

P3.41 control terminal description: Unit's digit : X1, Ten's digit : X 2, Hundred's digit : X 3, Thousand's digit : X 4, Ten thousand's digit : X 5.

P3.42 control terminal description : Unit's digit : X6, Ten's digit : X 7, Hundred's digit : X 8, Thousand's digit : X9, Ten thousand's digit : X10

P3.43 control terminal description : VI, CI.

6.5 Output Terminals (Group P4)

P4.00	FM terminal output mode	Setting Range : 0~1	0
--------------	--------------------------------	----------------------------	----------

0 : Pulse output (FMP) ; 1 : Switch signal output (FMR)

The FM terminal is programmable multiplexing terminal. It can be used for high-speed pulse output (FMP), with maximum frequency of 100 kHz. Refer to P4.06 for relevant functions of FMP. It can also be used as open collector switch signal output

(FMR) .

P4.01	FMR function (open-collector output terminal)	Setting Range : 0~41	0
P4.02	Relay function (T/A-T/B-T/C)	Setting Range : 0~41	2
P4.03	Extension card relay function (R/A-R/B-R/C)	Setting Range : 0~41	0
P4.04	DO1 function selection (open-collector output terminal)	Setting Range : 0~41	1
P4.05	Extension card DO2 function	Setting Range : 0~41	4

These five parameters are used to select the functions of the five digital output terminals. T/A-T/B-T/C and P/A-P/B-P/C are respectively the relays on the control board and the extension card.

The functions of the output terminals are described in the following table.

Table 6-3 Functions of output terminals

Value	Function	Value	Function
0	No output	1	AC drive running
2	Fault output (stop)	3	Frequency-level detection FDT1 output
4	Frequency reached	5	Zero-speed running(no output at stop)
6	Motor overload pre-warning	7	AC drive overload pre-warning
8	Set count value reached	9	Designated count reached
10	Length reached	11	PLC cycle complete
12	Current running time reached	13	Frequency limited
14	Reserved	15	Ready for RUN
16	VI larger than AI	17	Frequency upper limit reached
18	Frequency lower limit reached (no output at stop)	19	Under-voltage state output
20	Communication setting	21	Reserved

22	Accumulative running time reached	23	Zero-speed running 2 (having output at stop)
24	Accumulative power-on time	25	Frequency level detection FDT2 output
26	Frequency 1 reached	27	Frequency 2 reached
28	Current 1 reached	29	Current 2 reached
30	Timing reached	31	VI input limit exceeded
32	Load becoming 0	33	Reverse running
34	Zero current state	35	Module temperature reached
36	Software current limit exceeded	37	Frequency lower limit reached (having output at stop)
38	Fault output	39	Motor overheat warning
40	Current running time reached	41	Fault output (no output at undervoltage)

Function description :

0 : No output

The terminal has no function.

1 : AC drive running

When the AC drive is running and has output frequency (can be zero), the terminal becomes ON.

2 : Fault output (stop))

When the AC drive stops due to a fault, the terminal becomes ON.

3 : Frequency-level detection FDT1 output: Refer to the descriptions of P2.19 and P2.20.

4 : Frequency reached : Refer to the descriptions of P2.21.

5 : Zero-speed running (no output at stop)

If the AC drive runs with the output frequency of 0, the terminal becomes ON. If the AC drive is in the stop state, the terminal becomes OFF.

6 : Motor overload pre-warning

The AC drive judges whether the motor load exceeds the overload pre-warning threshold before performing the protection action. If the pre-warning threshold is exceeded, the terminal becomes ON. For motor overload parameters, see the descriptions of PA.00 to PA.02.

7 : AC drive overload pre-warning

The terminal becomes ON 10s before the AC drive overload protection action is performed.

8 : Set count value reached : The terminal becomes ON when the count value reaches the value set in PE.08.

9 : Designated count value reached : The terminal becomes ON when the designated value reaches the value set in PE.09.

10 : Length reached : The terminal becomes ON when the detected actual length exceeds the value set in PE.05.

11 : PLC cycle complete : When simple PLC completes one cycle, the terminal outputs a pulse signal with width of 250 ms.

12 : Current running time reached : If the current running time of the AC drive exceeds the time set in P2.51, the terminal becomes ON.

13 : Frequency limited

If the set frequency exceeds the frequency upper limit or lower limit and the output

frequency of the AC drive reaches the upper limit or lower limit, the terminal becomes ON.

15 : Ready for RUN

If the AC drive main circuit and control circuit become stable, and the AC drive detects no fault and is ready for RUN, the terminal becomes ON.

16 : VI larger than CI

When the input of VI is larger than the input of CI, the terminal becomes ON.

17 : Frequency upper limit reached

If the running frequency reaches the upper limit, the terminal becomes ON.

18 : Frequency lower limit reached (no output at stop)

If the running frequency reaches the lower limit, the terminal becomes ON. In the stop state, the terminal also becomes ON.

19 : Under-voltage state output

If the AC drive is in under-voltage state, the terminal becomes ON.

20 : Communication setting

DO output controlled by communication setting, refer to the communication protocol in chapter nine.

22 : Accumulative running time reached

If the accumulative running time of the AC drive exceeds the time set in P2.16, the terminal becomes ON.

23 : Zero-speed running 2 (having output at stop)

If the output frequency of the AC drive is 0, the terminal becomes ON. In the state of stop, the signal is still ON.

24 : Accumulative power-on time reached

If the AC drive accumulative power-on time exceeds the value set in P2.17, the terminal becomes ON.

25 : Frequency level detection FDT2 output : Refer to the descriptions of P2.26 and P2.27.

26 : Frequency 1 reached : Refer to the descriptions of P2.28 and P2.29.

27 : Frequency 2 reached : Refer to the descriptions of P2.30 and P2.31.

28 : Current 1 reached : Refer to the descriptions of P2.36 and P2.37. 29 : Current 2 reached : Refer to the descriptions of P2.38 and P2.39.

30 : Timing reached

If the timing function (P2.40) is valid, the terminal becomes ON after the current running time of the AC drive reaches the set time(P2.42).

31 : VI input limit exceeded

If VI input is larger than the value of P2.44(VI input voltage upper limit) or lower than the value of P2.43 (VI input voltage lower limit), the terminal becomes ON.

32 : Load becoming 0 :

If the load becomes 0, the terminal becomes ON.

33 : Reverse running :

If the AC drive is in the reverse running state, the terminal becomes ON.

34 : Zero current state : Refer to the descriptions of P2.32 and P2.33.

35 : Module temperature reached

If the heat-sink temperature of the inverter module (P7.06) reaches the set module temperature threshold (P2.45), the terminal becomes ON.

36 : Software current limit exceeded : Refer to the descriptions of P2.32 and P2.33

37 : Frequency lower limit reached (having output at stop)

If the running frequency reaches the lower limit, the terminal becomes ON. In the stop state, the signal becomes OFF.

38 : Fault output : If a fault occurs on the AC drive and the AC drive stop, the terminal becomes ON.

39 : Motor overheat warning

If the motor temperature (b0.34) reaches the temperature set in PA.54 (Motor overheat warning threshold), the terminal becomes ON.

40 : Current running time reached : If the current running time of AC drive exceeds the value of P2.51, the terminal becomes ON.

41 : Fault output

When the AC drive stops due to a fault, the terminal becomes ON.

Mark : No output when under-voltage

P4.06	FMP function selection	Setting Range : 0~16	0
P4.07	AO1 function selection	Setting Range : 0~16	0
P4.08	AO2 function selection	Setting Range : 0~16	1

The output pulse frequency of the FMP terminal ranges from 0.01 kHz to "Maximum FMP output frequency" (P5.09). The value of P5.09 is between 0.01 kHz and 100.00 kHz.

The output range of AO1 and AO2 is 0–10 V or 0–20 mA.

The relationship between pulse and analog output ranges and corresponding functions is listed in the following table.

Value	Function	Range (Corresponding to Pulse or Analog Output Range 0.0%–100.0%)
0	Running frequency	0 to maximum output frequency
1	Set frequency	0 to maximum output frequency
2	Output current	0~2 times of rated motor current
3	Output current	0.0A~1000.0A
4	Output torque (absolute value)	0 to 2 times of rated motor torque
5	Output torque (actual value)	-2 times of rated motor torque to 2 times of rated motor torque
6	Output voltage	0~1.2 times of rated AC drive voltage
7	Output voltage	0.0V~1000.0V
8	Motor rotational speed	0 to rotational speed corresponding to maximum output frequency
9	Output power	0~2 times of rated power
10	VI input	0~10V
11	CI input	0~10V (or 4~20mA)
12	Pulse input	0.01kHz~100.00kHz
13	Communication setting	0.0%~100.0%
14	Length	0 to maximum set length

15	Count value	0 to maximum count value
----	-------------	--------------------------

P4.09	Maximum FMP output frequency	Setting Range : 0.01kHz~ 100.00kHz	50.00kHz
--------------	-------------------------------------	---	-----------------

If the FM terminal is used for pulse output, this parameter is used to set the maximum frequency of pulse output.

P4.10	AO1 offset coefficient	Setting Range : -100.0%~ 100.0%	0.0%
P4.11	AO1 gain	Setting Range : -10.00~+10.00	1.00
P4.12	AO2 offset coefficient	Setting Range : -100.0%~ 100.0%	0.0%
P4.13	AO2 gain	Setting Range : -10.00~+10.00	1.00

These parameters are used to correct the zero drift of analog output and the output amplitude deviation. They can also be used to define the desired AO curve.

If "b" represents zero offset, "k" represents gain, "Y" represents actual output, and "X" represents standard output, the actual output is: $Y = kX + b$.

The zero offset coefficient 100% of AO1 and AO2 corresponds to 10 V (or 20 mA). The standard output refers to the value corresponding to the analog output of 0 to 10 V (or 0 to 20 mA) with no zero offset or gain adjustment.

For example, if the analog output is used as the running frequency, and it is expected that the output is 8 V when the frequency is 0 and 3 V at the maximum frequency, the gain shall be set to -0.50, and the zero offset shall be set to 80%.

P4.14	FM output delay time	Setting Range : 0.0s~3600.0s	0.0s
--------------	-----------------------------	-------------------------------------	-------------

P4.15	Relay1 output delay time	Setting Range : 0.0s~3600.0s	0.0s
P4.16	Relay2 output delay time	Setting Range : 0.0s~3600.0s	0.0s
P4.17	DO1 output delay time	Setting Range : 0.0s~3600.0s	0.0s
P4.18	DO2 output delay time	Setting Range : 0.0s~3600.0s	0.0s

These parameters are used to set the delay time of output terminals FM, relay 1, relay 2, DO1 and DO2 from status change to actual output.

P4.19	DO valid mode selection	Setting Range : 00000~11111	00000
-------	-------------------------	-----------------------------	-------

It is used to set the logic of output terminals FM, relay 1, relay 2, DO1 and DO2.

Unit's digit: FM valid mode ; Ten's digit: Relay 1 valid mode ; Hundred's digit: Relay 2 valid mode ; Thousand's digit: DO1 valid mode ; Ten thousand's digit:DO2 valid mode.

0: Positive logic, The output terminal is valid when being connected with COM, and invalid when being disconnected from COM.

1 : Positive logic, The output terminal is invalid when being connected with COM, and valid when being disconnected from COM.

6.6 V/F Control Parameter (Group P5)

P5.00	V/F curve setting	Setting Range : 00~11	00
-------	-------------------	-----------------------	----

According to the different load requirements, there are five kinds of curve modes can be selected base on P5.00 setting.

0 : Linear V/F : It is applicable to common constant torque load.

1 : Multi-point V/F : It is applicable to special load such as dehydrator and centrifuge. Any such V/F curve can be obtained by setting parameters of PA.01 to PA.06.

2 : Square V/F : It is applicable to centrifugal loads such as fan and pump.

10 : V/F complete separation : In this mode, the output frequency and output voltage of the AC drive are independent. The output frequency is determined by the frequency source, and the output voltage is determined by "Voltage source for V/F separation" (PA.13).It is applicable to induction heating, inverse power supply and torque motor control.

11 : V/F half separation : In this mode, V and F are proportional and the proportional relationship can be set in PA.12. The relationship between V and F are also related to the rated motor voltage and rated motor frequency in Group PA.

Assume that the voltage source input is X (0 to 100%), the relationship between V and F is:

$$V/F = 2 * X * (\text{Rated motor voltage})/(\text{Rated motor frequency})$$

P5.01	Torque boost	Setting Range : 0.0%~ 30.0%	Model dependent
--------------	---------------------	--	----------------------------

To compensate the low frequency torque characteristics of V/F control, you can boost the output voltage of the AC drive at low frequency by modifying P5.01.

If the torque boost is set to too large, the motor may overheat, and the AC drive may suffer overcurrent.

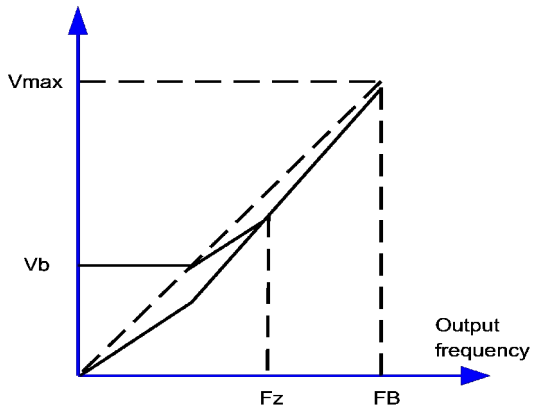
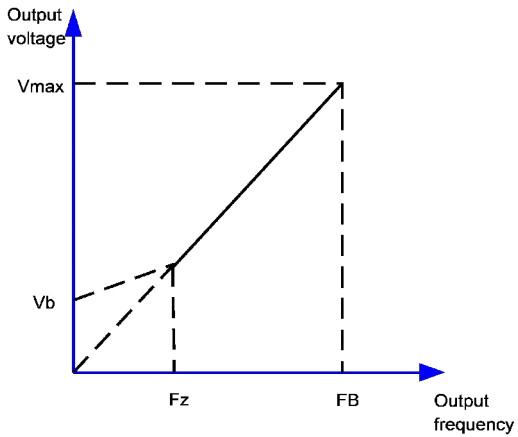

Vmax: Maximum Output voltage
Vb: Voltage of Manual torque boost
Fz: Cut-off frequency of Manual torque boost
FB: Rated running frequency

Figure 6-24 Manual torque boost

P5.02	Cut-off frequency of torque boost	Setting Range : 0.00 Hz to maximum output frequency	50
--------------	--	--	-----------

This parameter defines the cut-off frequency of torque boost, see Fz in figure 6-24, this cut-off frequency suitable for any V/F curve in P5.00.

P5.03	Multi-point V/F frequency 1 (F1)	Setting Range : 0.00Hz ~ P5.05	0.00Hz
P5.04	Multi-point V/F voltage 1 (V1)	Setting Range : 0%~ 100.0%	0.0%
P5.05	Multi-point V/F frequency 2 (F2)	Setting Range : P5.03 ~ P5.07	0.00Hz
P5.06	Multi-point V/F voltage 2 (V2)	Setting Range : 0%~ 100.0%	0.0%
P5.07	Multi-point V/F frequency 3 (F3)	Setting Range : P5.05 to rated motor frequency	0.00Hz
P5.08	Multi-point V/F voltage 3 (V3)	Setting Range : 0%~ 100.0%	0.0%

These six parameters are used to define the multi-point V/F curve.

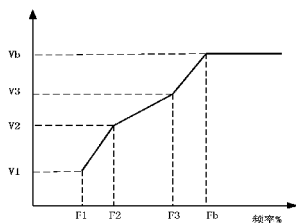

V1 ~ V3 : 1st, 2nd and 3rd voltage percentages of multi-point V/F

F1 ~ F3 : 1st, 2nd and 3rd frequency percentages of multi-point V/F

Fb : Rated motor running frequency

Figure 6-25 Setting of multi-point V/F curve

P5.09	V/F slip compensation gain	Setting Range : 0%~200%	0%
--------------	-----------------------------------	--------------------------------	-----------

This parameter is valid only for the asynchronous motor.

It can compensate the rotational speed slip of the asynchronous motor when the load of the motor increases, stabilizing the motor speed in case of load change. If this parameter is set to 100%, it indicates that the compensation when the motor bears rated load is the rated motor slip. The rated motor slip is automatically obtained by the AC drive through calculation based on the rated motor frequency and rated motor rotational speed in P8.05.

Generally, if the motor rotational speed is different from the target speed, slightly adjust this parameter.

P5.10	V/F over-excitation gain	Setting Range : 0~200	64
--------------	---------------------------------	------------------------------	-----------

During deceleration of the AC drive, over-excitation can restrain rise of the bus voltage, preventing the overvoltage fault. The larger the over-excitation is, the better the restraining result is.

Increase the over-excitation gain if the AC drive is liable to overvoltage error during deceleration. However, too large over-excitation gain may lead to an increase in the output current. Set P5.09 to a proper value in actual applications.

Set the over-excitation gain to 0 in the applications where the inertia is small and the bus voltage will not rise during motor deceleration or where there is a braking resistor.

P5.11	V/F oscillation suppression gain	Setting Range : 0~100	Model dependent
--------------	---	------------------------------	------------------------

Set this parameter to a value as small as possible in the prerequisite of efficient oscillation suppression to avoid influence on V/F control. Set this parameter to 0 if the motor has no oscillation. Increase the value properly only when the motor has obvious oscillation. The larger the value is, the better the oscillation suppression result will be.

When the oscillation suppression function is enabled, the rated motor current and no-load current must be correct. Otherwise, the V/F oscillation suppression effect will not be satisfactory.

P5.13	Voltage source for V/F separation	Setting Range : 0~8	Model dependent
--------------	--	----------------------------	------------------------

P5.00 setting to 10 or 11 : the function is valid when V/F separation.

0 : Digital setting(PA.13) : The output voltage is set directly by PA.13.

1 : VI

2 : CI

The output voltage is set by VI terminals.

4. Pulse setting : The output voltage is set by pulses of the terminal X5.

Pulse setting specification: voltage range 9~30 V, frequency range 0~100 kHz.

5. Multi-reference

If the voltage source is multi-reference, parameters in group PF must be set to determine the corresponding relationship between setting signal and setting voltage. 100.0% of the multi-reference setting in group PF corresponds to the rated motor voltage.

6. Simple PLC

If the voltage source is simple PLC mode, parameters in group PF must be set to determine the setting output voltage.

7. PID : The output voltage is generated based on PID closed loop. For details, see the description of PID in group PE.

8. Communication setting

The output voltage is set by the host computer by means of communication.

The voltage source for V/F separation is set in the same way as the frequency source. For details, see P0.01. 100.0% of the setting in each mode corresponds to the rated motor voltage. If the corresponding value is negative, its absolute value is used.

P5.14	Voltage digital setting for V/F separation	Setting Range : 0V to rated motor voltage	0
--------------	---	--	----------

When P5.13 set to 0, the output voltage is set by P5.14.

P5.15	Voltage rise time of V/F separation	Setting Range : 0.0S~1000.0S	0
--------------	--	---	----------

P5.15 indicates the time required for the output voltage to rise from 0 V to the rated motor voltage.

6.7 PID Function (Group P6)

PID control is a general process control method. By performing proportional, integral and differential operations on the difference between the feedback signal and the target signal, it adjusts the output frequency and constitutes a feedback system to stabilize the controlled counter around the target value.

It is applied to process control such as flow control, pressure control and temperature control. The following figure shows the principle block diagram of PID control.

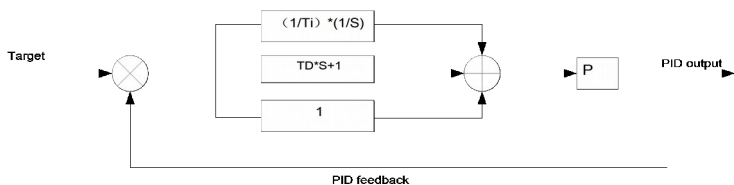

Figure 6-26 Principle block diagram of PID control

P6.00	PID setting source	Setting Range : 0~5	0
P6.01	PID digital setting	Setting Range : 0.0%~100.0%	50%

0 : P6.01 setting ; 1~2: VI, CI ; 4 : Pulse setting (X5/HDI)

5 : Communication setting

P6.00 is used to select the channel of target process PID setting. The PID setting is a relative value and ranges from 0.0% to 100.0%. The PID feedback is also a relative value. The purpose of PID control is to make the PID setting and PID feedback equal.

P6.02	PID feedback source	Setting Range : 0~8	0
--------------	----------------------------	----------------------------	----------

0~1: VI, CI ; 3 : VI-CI ; 4 : Pulse setting (X5/HDI) ; 5 : Communication setting ; 6 : VI ; 7 : MAX(|VI|, |CI|) ; 8 : MIN(|VI|, |CI|)

This parameter is used to select the feedback signal channel of process PID. The PID feedback is a relative value and ranges from 0.0% to 100.

P6.03	PID action direction	Setting Range :	0.00s
--------------	-----------------------------	------------------------	--------------

		0.00~60.00s	
--	--	--------------------	--

0 : Forward action.

When the feedback value is smaller than the PID setting, the AC drive's output frequency rises. For example, the winding tension control requires forward PID action.

1 : Reverse action.

When the feedback value is smaller than the PID setting, the AC drive's output frequency reduces. For example, the unwinding tension control requires reverse PID action.

Note that this function is influenced by the DI function 35 "Reverse PID action

direction".

P6.04	PID setting feedback range	Setting Range : 0~65535	1000
--------------	-----------------------------------	--------------------------------	-------------

This parameter is a non-dimensional unit. It is used for PID setting display (b0.15) and PID feedback display (b0.16).

Relative value 100% of PID setting feedback corresponds to the value of P6.04. If P6.04 is set to 2000 and PID setting is 100.0%, the PID setting display (b0.15) is 2000.

P6.05	Proportional gain Kp1	Setting Range : 0.0~100.0	20
P6.06	Integral time Ti1	Setting Range : 0.01s~10.00s	2.00s
P6.07	Differential time Td1	Setting Range : 0.000s~10.000s	0.000s

P6.05 : Proportional gain Kp1

It decides the regulating intensity of the PID regulator. The higher the Kp1 is, the larger the regulating intensity is. The value 100.0 indicates when the deviation between PID feedback and PID setting is 100.0%, the adjustment amplitude of the PID regulator on the output frequency reference is the maximum frequency.

P6.06 : Integral time T_{I1}

It decides the integral regulating intensity. The shorter the integral time is, the larger the regulating intensity is. When the deviation between PID feedback and PID setting is 100.0%, the integral regulator performs continuous adjustment for the time set in P6.06. Then the adjustment amplitude reaches the maximum frequency.

P6.07 : Differential time T_{d1}

It decides the regulating intensity of the PID regulator on the deviation change. The longer the differential time is, the larger the regulating intensity is. Differential time is the time within which the feedback value change reaches 100.0%, and then the adjustment amplitude reaches the maximum frequency.

P6.08	Cut-off frequency of PID reverse rotation	Setting Range : 0.00 to maximum frequency	2.00Hz
--------------	--	--	---------------

In some situations, only when the PID output frequency is a negative value (AC drive reverse rotation), PID setting and PID feedback can be equal. However, too high reverse rotation frequency is prohibited in some applications, and P6.08 is used to determine the reverse rotation frequency upper limit.

P6.09	PID deviation limit	Setting Range : 0.0%~100.0%	0.01%
--------------	----------------------------	---------------------------------------	--------------

If the deviation between PID feedback and PID setting is smaller than the value of P6.09, PID control stops. The small deviation between PID feedback and PID setting will make the output frequency stabilize, effective for some closed-loop control applications.

P6.10	PID differential limit	Setting Range : 0.00%~100.00%	0.10%
--------------	-------------------------------	---	--------------

It is used to set the PID differential output range. In PID control, the differential operation may easily cause system oscillation. Thus, the PID differential regulation is restricted to a small range.

P6.11	PID setting change time	Setting Range : 0.00s~650.00s	[0.00s]
--------------	--------------------------------	---	----------------

The PID setting change time indicates the time required for PID setting changing from 0.0% to 100.0%. The PID setting changes linearly according to the change time, reducing the impact caused by sudden setting change on the system.

P6.12	PID feedback filter time	Setting Range : 0.00~60.00s	[0.00s]
P6.13	PID output filter time	Setting Range : 0.00~60.00s	[0.00s]

P6.12 is used to filter the PID feedback, helping to reduce interference on the feedback but

slowing the response of the process closed-loop system.

P6.13 is used to filter the PID output frequency, helping to weaken sudden change of the AC drive output frequency but slowing the response of the process closed-loop system.

P6.15	Proportional gain Kp2	Setting Range : 0.0~100.0	[20.0]
P6.16	Integral time Ti2	Setting Range : 0.01s~ 10.00s	[2.00s]
P6.17	Differential time Td2	Setting Range : 0.00~10.000	[0.000s]
P6.18	PID parameter switchover condition	Setting Range : 0~2	[0]
P6.19	PID parameter switchover deviation 1	Setting Range : 0.0%~PE.19	[20.0%]
P6.20	PID parameter switchover deviation 2	Setting Range : PE.18~100.0%	[80.0%]

These parameters are used for switchover between two groups of PID parameters. P6.18 set parameter switchover condition: 0: No switchover; 1: Switchover via X; 2: Automatic switchover based on deviation.

Regulator parameters P6.15 to P6.16 are set in the same way as P6.05 to P6.07.

If you select switchover via a DI terminal, the DI must be allocated with function 37 "PID parameter switchover". If the DI is OFF, group 1 (P6.05 to P6.07) is selected. If the DI is ON, group 2 (P6.15 to P6.17) is selected.

If you select automatic switchover, when the absolute value of the deviation between PID

feedback and PID setting is smaller than the value of P6.19, group 1 is selected. When the absolute value of the deviation between PID feedback and PID setting is higher than the value of P6.20, group 2 is selected. When the deviation is between P6.19 and P6.20, the PID parameters are the linear interpolated value of the two groups of parameter values.

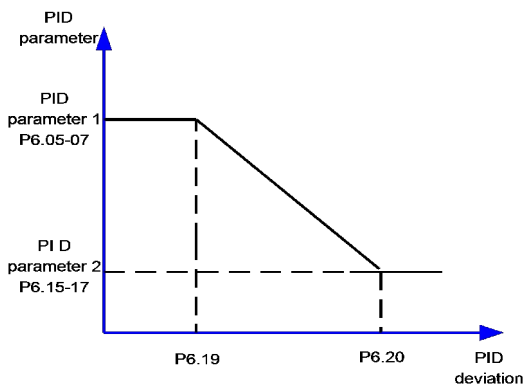

Figure 6-27 PID parameters switchover

P6.21	PID initial value	Setting Range : 0.0%~100.0%	[0.0%]
P6.22	PID initial value holding time	Setting Range : 0.00~650.00s	[0.00s]

When the AC drive starts up, the PID starts closed-loop algorithm only after the PID output is fixed to the PID initial value (P6.21) and lasts the time set in P6.23, see figure 6-28.

P6.23	Maximum deviation between two PID outputs in forward direction	Setting Range : 0.0%~100.0%	[1.00%]
--------------	---	--	----------------

P6.24	Maximum deviation between two PID outputs in reverse direction	Setting Range : 0.0%~100.0%	[1.00%]
--------------	---	--	----------------

This function is used to limit the deviation between two PID outputs (2 ms per PID output) to suppress the rapid change of PID output and stabilize the running of the AC drive.

P6.23 and P6.24 respectively correspond to the maximum absolute value of the output deviation in forward direction and in reverse direction.

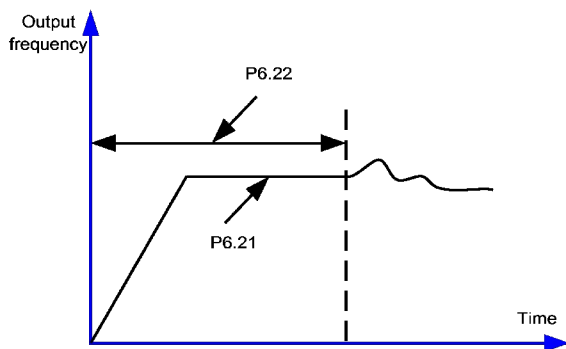

Figure 6-28 PID initial value function

P6.25	PID integral property	Setting Range : 00~11	[00]
--------------	------------------------------	------------------------------	-------------

Unit's digit (Integral separated) 0 : Invalid ; 1 : Valid

If it is set to valid, , the PID integral operation stops when the X allocated with function 38 "PID integral pause" is ON. In this case, only proportional and differential operations take effect.

If it is set to invalid, integral separated remains invalid no matter whether the X allocated

with function 38 "PID integral pause" is ON or not.

Ten's digit : Whether to stop integral operation when the output reaches the limit ; 0 : Continue integral operation ; 1 : Stop integral operation.

If "Stop integral operation" is selected, the PID integral operation stops, which may help to reduce the PID overshoot.

P6.26	Detection value of PID feedback loss	Setting Range : 0.1%~ 100.0%	[0.0%]
P6.27	Detection time of PID feedback loss	Setting Range : 0.0s~ 20.0s	[1s]

These parameters are used to judge whether PID feedback is lost. Not judging feedback loss when set P6.26 to 0.0%.

If the PID feedback is smaller than the value of P6.26 and the lasting time exceeds the value of P6.27, the AC drive reports Err31 and acts according to the selected fault protection action.

P6.28	PID operation at stop	Setting Range : 0~1	[0]
--------------	------------------------------	----------------------------	------------

0 : No PID operation at stop ; 1 : PID operation at stop

It is used to select whether to continue PID operation in the state of stop. Generally, the PID operation stops when the AC drive stops.

6.8 Operation Panel and Display (Group P7)

P7.00	REV key function selection	Setting Range : 0~4	3
--------------	-----------------------------------	----------------------------	----------

0 : **REV** key disabled

1 : Switchover between operation panel control and remote command control. You can perform switchover from the current command source to the operation panel control (local operation).

If the current command source (P0.03) is operation panel control, this key is invalid..

2 : Switchover between forward rotation and reverse rotation : You can change the direction of the frequency reference by using the **REV** key.

It is valid only when the current command source is operation panel control.

3 : Forward JOG : You can perform forward JOG (FJOG) by using the **REV** key.

4 : Reverse JOG: You can perform reverse JOG (FJOG) by using the **REV** key.

P7.01	STOP key function	Setting Range : 0~1	0
--------------	--------------------------	----------------------------	----------

0 : STOP key enabled only in operation panel control.

1 : STOP key enabled in any operation mode.

P7.02	LED display running parameter 1	Setting Range : 0x 0000 ~0x FFFF	0x1F
P7.03	LED display running parameter 2	Setting Range : 0x 0000 ~0x FFFF	0x00

These two parameters are used to set the parameters that can be viewed when the AC drive is in the running state. You can view a maximum of 32 running state parameters that are displayed from the lowest bit of P7.02.

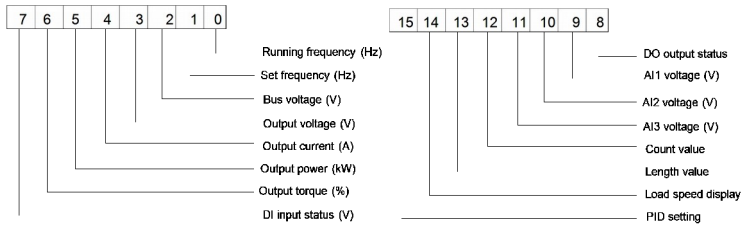

Figure6-29 P7.02 unit's definition

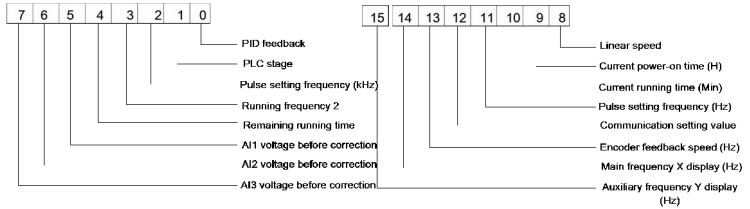

Figure6-30 P7.03 unit's definition

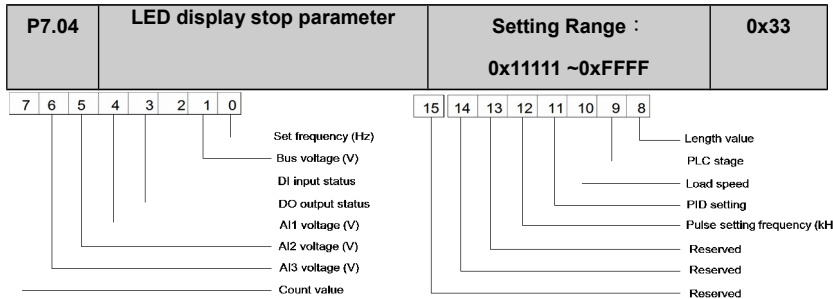
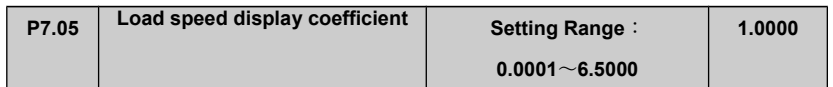

Figure 6-31 P7.04 unit's definition



This parameter is used to adjust the relationship between the output frequency of the AC drive and the load speed. For details, see the description of P7.11. Function Code Parameter Name Setting

P7.06	Heatsink temperature of inverter module	Setting Range : 0.0°C~100°C	0°C
--------------	--	--	------------

It is used to display the insulated gate bipolar transistor (IGBT) temperature of the inverter module, and the IGBT overheat protection value of the inverter module depends on the model.

P7.07	Temporary software version	Setting Range : YH.9000	YH.9000
P7.08	Accumulative running time	Setting Range : 0h~ 65535h	0h

It is used to display the accumulative running time of the AC drive. After the accumulative running time reaches the value set in P2.17, the terminal with the digital output function 12 becomes ON.

P7.11	Number of decimal places for load speed display	Setting Range : 0~3	0h
--------------	--	----------------------------	-----------

0 : 0 decimal place ; 1 : 1decimal place ; 2 : 2 decimal place ; 3 : 3 decimal place

P7.11 is used to set the number of decimal places for load speed display. The following gives an example to explain how to calculate the load speed:

Assume that P7.05 (Load speed display coefficient) is 2.000 and P7.05 is 2 (2 decimal places). When the running frequency of the AC drive is 40.00 Hz, the load speed is $40.00 \times 2.000 = 80.00$ (display of 2 decimal places).

If the AC drive is in the stop state, the load speed is the speed corresponding to the set frequency, namely, "set load speed". If the set frequency is 50.00 Hz, the load speed in the stop state is $50.00 \times 2.000 = 100.00$ (display of 2 decimal places).

P7.12	Accumulative power-on time	Setting Range : 0h~65535h	0h
--------------	-----------------------------------	--	-----------

It is used to display the accumulative power-on time of the AC drive since the delivery.

If the time reaches the set power-on time (P2.16), the terminal with the digital output function 24 becomes ON.

P7.13	Accumulative power consumption	Setting Range : 0~65535 kWh	0
--------------	---------------------------------------	--	----------

It is used to display the accumulative power consumption of the AC drive until now.

6.9 Motor Parameters (Group P8)

P8.00	Motor type selection	0 : Common asynchronous motor 1 : Variable frequency asynchronous motor	0
P8.01	Rated motor power	Setting Range: 0.1KW~1000.0KW	Model dependent
P8.02	Rated motor voltage	Setting Range: 0~2000V	Model dependent
P8.03	Rated motor current	Setting Range: 0.01A~655.35 A	Model dependent
P8.04	Rated motor frequency	Setting Range: 0.01HZ to	Model

		maximum frequency	dependent
P8.05	Rated motor rotational speed	Setting Range: 1~65535 RPM	Model dependent

Set the parameters according to the motor nameplate no matter whether V/F control or vector control is adopted.

To achieve better V/F or vector control performance, motor auto-tuning is required. The motor auto-tuning accuracy depends on the correct setting of motor nameplate parameters.

P8.06	Stator resistance	Setting Range: 0.001Ω~65.535Ω	Model dependent
P8.07	Rotor resistance	Setting Range: 0.001Ω~65.535Ω	Model dependent
P8.08	Leakage inductive reactance	Setting Range: 0.01mH~655.35mH	Model dependent
P8.09	Mutual inductive reactance	Setting Range: 0.01mH~655.35mH	Model dependent
P8.10	No-load current	Setting Range: 0.01A~655.35 A	Model dependent

The parameters in P8.06 to P8.10 are asynchronous motor parameters. These parameters are unavailable on the motor nameplate and are obtained by means of motor auto-tuning. Only P8.06 to P8.08 can be obtained through static motor auto-tuning. Through complete motor auto-tuning, encoder phase sequence and current loop PI can be obtained besides the parameters in P8.06 to P8.10.

Each time "Rated motor power" (P8.01) or "Rated motor voltage" (P8.02) is changed; the AC drive automatically restores values of

P8.06 to P8.10 to the parameter setting for the common standard Y series asynchronous motor.

P8.27	Encoder pulses per revolution	Setting Range: 1~65535	1024
--------------	--------------------------------------	-------------------------------	-------------

This parameter is used to set the pulses per revolution (PPR) of ABZ or UVW incremental encoder. In CLVC mode, the motor cannot run properly if this parameter is set incorrectly.

P8.28	Encoder type	Setting Range: 0~4	0
--------------	---------------------	---------------------------	----------

0 : ABZ incremental encoder ; 1 : UVW incremental encoder ; 2 : Resolver ; 3 : SIN/COS encoder; 4 : Wire-saving UVW encoder.

The DGI900 supports multiple types of encoder. Different PG cards are required for different types of encoder. Select the appropriate PG card for the encoder used. Any of the five encoder types is applicable to synchronous motor. Only ABZ incremental encoder and resolver are applicable to asynchronous motor.

After installation of the PG card is complete, set P8.28 properly based on the actual condition. Otherwise, the AC drive cannot run properly.

P8.30	A/B phase sequence of ABZ incremental encoder	Setting Range: 0~1	0
--------------	--	---------------------------	----------

0 : Forward ; 1 : Reverse.

This parameter is valid only for ABZ incremental encoder (P8.28 = 0) and is used to set the A/B phase sequence of the ABZ incremental encoder.

P8.34	Number of pole pairs of resolver	Setting Range: 1~65535	1
--------------	---	-------------------------------	----------

If a resolver is applied, set the number of pole pairs properly.

P8.37	Auto-tuning selection	Setting Range: 0~2	0
--------------	------------------------------	---------------------------	----------

0 : No auto-tuning

1 : Asynchronous motor static auto-tuning

It is applicable to scenarios where complete auto-tuning cannot be performed because the asynchronous motor cannot be disconnected from the load.

Before performing static auto-tuning, properly set the motor type and motor nameplate parameters of P8.00 to P8.05 first. The AC drive will obtain parameters of P8.06 to P8.08 by static auto-tuning.

Set this parameter to 1, and press FWD. Then, the AC drive starts static auto-tuning.

2 : Asynchronous motor complete auto-tuning

To perform this type of auto-tuning, ensure that the motor is disconnected from the load. During the process of complete auto-tuning, the AC drive performs static auto-tuning first and then accelerates to 80% of the rated motor frequency within the acceleration time set in P0.12. The AC drive keeps running for a certain period and then decelerates to stop within deceleration time set in P0.13.

Before performing complete auto-tuning, properly set the motor type, motor nameplate parameters of P8.00 to P8.05, "Encoder type" (P8.27) and "Encoder pulses per revolution" (P8.28) first.

The AC drive will obtain motor parameters of P8.06 to P8.10, "A/B phase sequence of ABZ incremental encoder" (P8.30) and vector control current loop PI parameters of P8.14 to P8.17 by complete auto-tuning.

Set this parameter to 2, and press RUN. Then, the AC drive starts complete auto-tuning.

6.10 Torque Control and Vector Control Parameters (Group P9)

P9.00	Speed/Torque control selection	Setting Range: 0~1	0
--------------	---------------------------------------	---------------------------	----------

0 : Speed control ; 1: Torque control

The DGI900 provides X terminals with two torque related functions, function 29 (Torque control prohibited) and function 46 (Speed control/Torque control switchover). The two X terminals need to be used together with P9.00 to implement speed control/torque control switchover.

If the X terminal allocated with function 46 (Speed control/Torque control switchover) is OFF, the control mode is determined by P9.00. If the X terminal allocated with function 46 is ON, the control mode is reverse to the value of P9.00.

However, if the DI terminal with function 29 (Torque control prohibited) is ON, the AC drive is fixed to run in the speed control mode.

P9.01	ASR Speed loop proportional gain Kp1	Setting Range: 0~100	30
P9.02	ASR Speed loop integral time Ti1	Setting Range: 0.01s~10.00s	0.50s
P9.03	Switchover frequency 1	Setting Range: 0.00~P9.05	5.00Hz
P9.04	ASR Speed loop proportional gain Kp2	Setting Range: 0~100	20

P9.05	ASR Speed loop integral time Ti2	Setting Range: 0.01s~10.00s	1.00s
P9.06	Switchover frequency 2	Setting Range: P9.03 to maximum output frequency	1000Hz

Speed loop PI parameters vary with running frequencies of the AC drive.

If the running frequency is less than or equal to "Switchover frequency 1" (P9.03), the speed loop PI parameters are P9.01 and P9.02.

If the running frequency is equal to or greater than "Switchover frequency 2" (P9.06), the speed loop PI parameters are P9.04 and P9.05.

If the running frequency is between P9.03 and P9.06, the speed loop PI parameters are obtained from the linear switchover between the two groups of PI parameters, as shown in Figure 6-32.

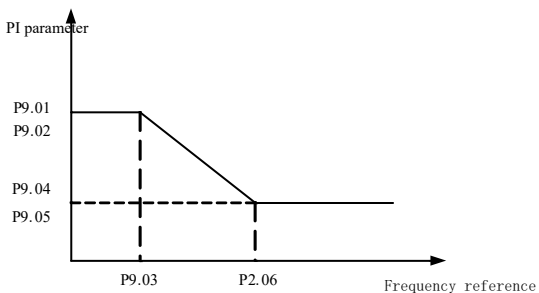

Figure 6-32. Relationship between running frequencies and PI parameters

The speed dynamic response characteristics in vector control can be adjusted by setting the

proportional gain and integral time of the speed regulator.

To achieve a faster system response, increase the proportional gain and reduce the integral time. Be aware that this may lead to system oscillation.

The recommended adjustment method is as follows:

If the factory setting cannot meet the requirements, make proper adjustment. Increase the proportional gain first to ensure that the system does not oscillate, and then reduce the integral time to ensure that the system has quick response and small overshoot.

NOTE: Improper PI parameter setting may cause too large speed overshoot, and overvoltage fault may even occur when the overshoot drops.

P9.07	Vector control slip gain	Setting Range: 50%~200%	100%
--------------	---------------------------------	--------------------------------	-------------

For SFVC, it is used to adjust speed stability accuracy of the motor. When the motor with load runs at a very low speed, increase the value of this parameter; when the motor with load runs at a very large speed, decrease the value of this parameter.

For CLVC, it is used to adjust the output current of the AC drive with same load.

P9.08	Time constant of speed loop filter	Setting Range: 0.000s~0.100s	0.000s
--------------	---	-------------------------------------	---------------

In the vector control mode, the output of the speed loop regulator is torque current reference. This parameter is used to filter the torque references. It need not be adjusted generally and can be increased in the case of large speed fluctuation. In the case of motor oscillation, decrease the value of this parameter properly.

If the value of this parameter is small, the output torque of the AC drive may fluctuate greatly, but the response is quick.

P9.09	Vector control over-excitation gain	Setting Range: 0~200	64
--------------	--	-----------------------------	-----------

During deceleration of the AC drive, over-excitation control can restrain rise of the bus voltage to avoid the overvoltage fault. The larger the over-excitation gain is, the better the restraining effect is.

Increase the over-excitation gain if the AC drive is liable to overvoltage error during deceleration. Too large over-excitation gain, however, may lead to an increase in output current. Therefore, set this parameter to a proper value in actual applications.

Set the over-excitation gain to 0 in applications of small inertia (the bus voltage will not rise during deceleration) or where there is a braking resistor.

P9.10	Torque upper limit source in speed control mode	Setting Range: 0~5	0
P9.11	Digital setting of torque upper limit in speed control mode	Setting Range: 0.0%~ 200.0%	150.0%

0 : P9.11 setting ; 1 : VI ; 2 : CI ; 4 : X5 Pulse setting ; 5 : Communication setting.

In the speed control mode, the maximum output torque of the AC drive is restricted by P9.10. If the torque upper limit is analog, pulse or communication setting, 100% of the setting corresponds to the value of P9.11, and 100% of the value of P9.11 corresponds to the AC drive rated torque.

For details on the VI and C setting, see the description of the AI curves in group P3.

For details on the pulse setting, see the description of P3.32 to P3.35.

When the AC drive is in communication with the master, the host computer writes data -100.00% to 100.00% by the communication address 0x1000, where 100.0% corresponds to the value of P9.11.

P9.14	Excitation adjustment proportional gain	Setting Range: 0 ~20000	2000
P9.15	Excitation adjustment integral gain	Setting Range: 0 ~20000	2000
P9.16	Torque adjustment proportional gain	Setting Range: 0 ~20000	2000
P9.17	Torque adjustment integral gain	Setting Range: 0 ~20000	2000

These are current loop PI parameters for vector control. These parameters are automatically obtained through "Asynchronous motor complete auto-tuning" or "Synchronous motor no-load auto-tuning", and need not be modified.

The dimension of the current loop integral regulator is integral gain rather than integral time.

Note that too large current loop PI gain may lead to oscillation of the entire control loop. Therefore, when current oscillation or torque fluctuation is great, manually decrease the proportional gain or integral gain here.

P9.24	Torque setting source in torque control	0~5	0
P9.26	Torque digital setting in torque control	0.0%~200.0%	150.0%

For details of these parameters setting, refer to P9.10 (P9.24) and P9.11 (P9.26) .

P9.28	Forward maximum frequency in torque control	0.00Hz to maximum frequency	50.00Hz
P9.29	Reverse maximum frequency in torque control	0.00Hz to maximum frequency	50.00Hz

Two parameters are used to set the maximum frequency in forward or reverse rotation in torque control mode.

In torque control, if the load torque is smaller than the motor output torque, the motor's rotational speed will rise continuously. To avoid runaway of the mechanical system, the motor maximum rotating speed must be limited in torque control.

You can implement continuous change of the maximum frequency in torque control dynamically by controlling the frequency upper limit.

P9.30	Acceleration time in torque control	0.00s~65000s	0.00s
P9.31	Deceleration time in torque control	0.00s~65000s	0.00s

In torque control, the difference between the motor output torque and the load torque determines the speed change rate of the motor and load. The motor rotational speed may change quickly and this will result in noise or too large mechanical stress. The setting of acceleration/deceleration time in torque control makes the motor rotational speed change softly.

However, in applications requiring rapid torque response, set the acceleration/deceleration time in torque control to 0.00s.

6.11 Parameter Protection (Group PA)

PA00	Motor overload protection selection	Setting Range : 0~1	1
-------------	--	----------------------------	----------

0 : Disabled

The motor overload protective function is disabled. The motor is exposed to potential damage due to overheating. A thermal relay is suggested to be installed between the AC drive and the motor.

1 : Enabled

The AC drive judges whether the motor is overloaded according to the inverse time-lag curve of the motor overload protection.

PA.01	Motor overload protection gain	0.20~10.00	1.00
--------------	---------------------------------------	-------------------	-------------

The inverse time-lag curve of the motor overload protection is:

$220\% \times PA.01 \times \text{rated motor current}$ (if the load remains at this value for one minute, the AC drive reports motor overload fault), or

$150\% \times PA.01 \times \text{rated motor current}$ (if the load remains at this value for 60 minutes, the AC drive reports motor overload fault).

NOTE: Set PA.01 properly based on the actual overload capacity. If the value of PA.01 is set too large, damage to the motor may result because the motor overheats but the AC drive does not report the alarm.

PA.02	Motor overload warning coefficient	Setting Range : 50%~100%	80%
--------------	---	---------------------------------	------------

This function is used to give a warning signal to the control system via DO before motor overload protection. This parameter is used to determine the percentage, at which pre-

warning is performed before motor overload. The larger the value is, the less advanced the pre-warning will be.

When the accumulative output current of the AC drive is greater than the value of the overload inverse time-lag curve multiplied by PA.02, the DO terminal on the AC drive allocated with function 6 (Motor overload pre-warning) becomes ON.

PA.03	Over voltage stall gain	Setting Range : 0~100	0
PA.04	Over voltage stall protective voltage	Setting Range : 120%~150%	130%

When the DC bus voltage exceeds the value of PA.04 (Overvoltage stall protective voltage) during deceleration of the AC drive, the AC drive stops deceleration and keeps the present running frequency. After the bus voltage declines, the AC drive continues to decelerate.

PA.03 (Overvoltage stall gain) is used to adjust the overvoltage suppression capacity of the AC drive. The larger the value is, the greater the overvoltage suppression capacity will be.

In the prerequisite of no overvoltage occurrence, set PA.03 to a small value.

For small-inertia load, the value should be small. Otherwise, the system dynamic response will be slow. For large-inertia load, the value should be large. Otherwise, the suppression result will be poor and an overvoltage fault may occur.

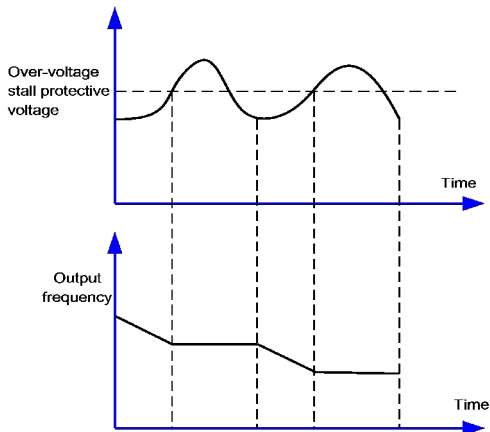

Figure 6-33 over-voltage stall protection function

PA.05	Overcurrent stall gain	Setting Range : 0~100	20
PA.06	Overcurrent stall protective current	Setting Range : 120%~150%	150%

When the output current exceeds the overcurrent stall protective current during acceleration/deceleration of the AC drive, the AC drive stops acceleration/deceleration and keeps the present running frequency. After the output current declines, the AC drive continues to accelerate/decelerate.

PA.05 (Overcurrent stall gain) is used to adjust the overcurrent suppression capacity of the AC drive. The larger the value is, the greater the overcurrent suppression capacity will be. In the prerequisite of no overcurrent occurrence, set PA.05 to a small value.

For small-inertia load, the value should be small. Otherwise, the system dynamic response will be slow. For large-inertia load, the value should be large. Otherwise, the suppression result will be poor and overcurrent fault may occur.

If the overcurrent stall gain is set to 0, the overcurrent stall function is disabled.

PA.09	Fault auto reset times	Setting Range : 0~20	0
PA.10	DO action during fault auto reset	Setting Range : 0~1	1
PA.11	Time interval of fault auto reset	Setting Range : 0.1s~100.0s	1.0s

It is used to set the times of fault auto resets if this function (PA.09) is used. After the value is exceeded, the AC drive will remain in the fault state.

It is used to decide whether the DO acts during the fault auto reset if the fault auto reset function is selected, you can set by PA.10.

0 : Not act

1 : Act

PA.11 used to set the waiting time from the alarm of the AC drive to fault auto reset.

PA.12	Input phase loss protection/contactor energizing protection selection	Setting Range : 00~11	11
-------	---	-----------------------	----

Unit's digit: Input phase loss protection **0 : Disabled; 1 : Enabled**

Ten's digit: Contactor energizing protection **0 : Disabled; 1 : Enabled**

PA.13	Output phase loss protection selection	Setting Range : 0~1	1
-------	--	---------------------	---

It is used to determine whether to perform output phase loss protection.

0 : Disabled; 1 : Enabled

PA.14	1st fault type	Setting Range : 0~99	1
PA.15	2nd fault type	Setting Range : 0~99	1
PA.16	3rd (latest) fault type	Setting Range : 0~99	1

It is used to record the types of the most recent three faults of the AC drive. 0 indicates no fault. For possible causes and solution of each fault, refer to Chapter 7.

PA.17	Frequency upon 3rd fault	It displays the frequency when the latest fault occurs.	0.00Hz
PA.18	Current upon 3rd fault	It displays the current when the latest fault occurs.	0.00A
PA.19	Bus voltage upon 3rd fault	It displays the bus voltage when the latest fault occurs	0.00v
PA.20	X terminals status upon 3rd fault	Setting Range : 0~1111111111	0
PA.21	Output terminal status upon 3rd fault	Setting Range : 0~11111	0
PA.23	Power-on time upon 3rd fault	Setting Range : 0~65535h	0
PA.24	Running time upon 3rd fault	Setting Range : 0~65535h	0

PA.20 displays the status of all X terminals when the latest fault occurs, the sequence is BIT9~ BIT0 refer to X10~ X1.

If an X is ON, the setting is 1. If the X is OFF, the setting is 0. The value is the equivalent decimal number converted from the X status..

PA.21 displays the status of all output terminals when the latest fault occurs, the sequence is BIT4-DO2, BIT3-DO1, BIT2-REL2, BIT1-REL1, BIT0-FM.

If an output terminal is ON, the setting is 1. If the output terminal is OFF, the setting is 0. The value is the equivalent decimal number converted from the X statuses.

PA.25~ PA.32	2nd fault information	Setting Range : same as PA.17 to PA.24	0
---------------------	---	---	----------

PA.25 to PA.32 are the information of 2nd fault, refer to PA.17 to PA.24

PA.33~ PA.40	1st fault information	Setting Range : same as PA.17 to PA.24	0
---------------------	---	---	----------

PA.33 to PA.40 are the information of 3rd fault, refer to PA.17 to PA.24

PA.43	Fault protection action selection 1	Setting Range : 00000~22222	00000
PA.44	Fault protection action selection 2	Setting Range : 00000~22222	00000
PA.45	Fault protection action selection 3	Setting Range : 00000~22222	00000
PA.46	Fault protection	Setting Range :	00000

	action selection 4	0000~2222	
--	---------------------------	------------------	--

PA.43、PA.44、PA.35 and PA.36 are used to stop the AC drive when fault occurs, setting range, **0 : Coast to stop ; 1 : Stop according to the stop mode ; 2 : Continue to run.**

PA.43 Fault protection action selection 1

Unit's digit : Motor overload(E-11); Ten's digit: Power input phase loss(E-12) ; Hundred's digit: External equipment fault (E-15) ; Thousand's digit : Communication fault (E-16) ; Ten thousand's digit : EEPROM read-write fault (E-17)

PA.44 Fault protection action selection 2

Unit's digit : Power input phase loss (E-19) ; Ten's digit : Encoder fault (E-21) ; Hundred's digit : Accumulative running time reached (E-23) ; Thousand's digit : \perp Accumulative power-on time reached (E-24) ; Ten thousand's digit : Motor overheat (E-27)

PA.45 Fault protection action selection 3

Unit's digit : Too large speed deviation (E-28) 1 ; Ten's digit : Motor over-speed (E-29) 2 ; Hundred's digit : Load becoming 0 ; Thousand's digit : PID feedback lost during running(E-34) ; Ten thousand's digit: Reserved

PA.46 Fault protection action selection 4

Unit's digit : User-defined fault 1 (E-32) ; Ten's digit : User-defined fault 2(E-33)

PA.50	Frequency selection for continuing to run upon fault	Setting Range : 0~4	0
--------------	---	----------------------------	----------

0 : Current running frequency ; 1 : Set frequency ; 2 : Frequency upper limit ; 3: Frequency lower limit ; 4: Backup frequency upon abnormality

If a fault occurs during the running of the AC drive and the handling of fault is set to "Continue to run", the AC drive displays A-** and continues to run at the frequency set in PA.50.

Note :

(**)content is confirmed by fault, for example if the fault is Power input phase loss (E-12), then the ac drive display A-12.

PA.51	Backup frequency upon abnormality	Setting Range : 60%~100%	100%
--------------	--	---------------------------------	-------------

The setting of PA.51 is a percentage relative to the maximum frequency.

PA.53	Motor overheat protection threshold	Setting Range : 0°C~200°C	110°C
PA.54	Motor overheat warning threshold	Setting Range : 0°C~200°C	90°C

PA.55	Action selection at instantaneous power failure	Setting Range: 0~2	0
PA.56	Action pause judging voltage at instantaneous power failure	Setting Range: 80%~100%	90
PA.57	Voltage rally judging time at instantaneous power failure	Setting Range: 0.00s~100.00s	0.5S
PA.58	Action judging voltage at instantaneous power failure	Setting Range: 60%~100%	80

Upon instantaneous power failure or sudden voltage dip, the DC bus voltage of the AC drive reduces. This function enables the AC drive to compensate the DC bus voltage reduction with the load feedback energy by reducing the output frequency so as to keep the AC drive running continuously.

If PA.55 = 1, upon instantaneous power failure or sudden voltage dip, the AC drive decelerates. Once the bus voltage resumes to normal, the AC drive accelerates to the set frequency. If the bus voltage remains normal for the time exceeding the value set in PA.57, it is considered that the bus voltage resumes to normal.

If PA.55 = 2, upon instantaneous power failure or sudden voltage dip, the AC drive decelerates to stop.

For details, see the following figure 6-34

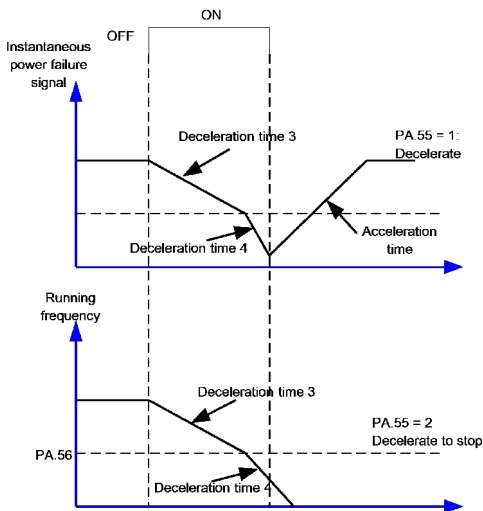

Figure 6-34 AC drive action diagram upon instantaneous power failure

PA.59	Protection upon load becoming 0	Setting Range: 0~1	1
PA.60	Detection level of load becoming 0	Setting Range: 0.0%~100.0%	10.0%
PA.61	Detection time of load becoming 0	Setting Range: 0.0s~60.0s	1.0s

0 : Disabled ; 1 : Enabled

If protection upon load becoming 0 is enabled, when the output current of the AC drive is lower than the detection level (PA.60) and the lasting time exceeds the detection time (PA.61), the output frequency of the AC drive automatically declines to 7% of the rated frequency. During the protection, the AC drive automatically accelerates to the set frequency if the load resumes to normal.

PA.63	Over-speed detection value	Setting Range: 0.0%~50.0%	20.0%
PA.64	Over-speed detection time	Setting Range: 0.0s~60.0s	1.0s

This function is valid only when the AC drive runs in the CLVC mode.

If the actual motor rotational speed detected by the AC drive exceeds the maximum frequency and the excessive value is greater than the value of PA.63 and the lasting time exceeds the value of PA.64, the AC drive reports E-29 and acts according to the selected

fault protection action.

If the over-speed detection time is 0.0s, the over-speed detection function is disabled.

PA.65	Detection value of too large speed deviation	Setting Range: 0.0%~50.0%	20.0%
PA.66	Detection time of too large speed deviation	Setting Range: 0.0s~60.0s	5.0s

This function is valid only when the AC drive runs in the CLVC mode.

If the AC drive detects the deviation between the actual motor rotational speed detected by the AC drive and the set frequency is greater than the value of PA.65 and the lasting time exceeds the value of PA.66, the AC drive reports E-30 and according to the selected fault protection action.

If PA.66 (Detection time of too large speed deviation) is 0.0s, this function is disabled.

6.12 Multi-Reference and Simple PLC Function (Group Pb)

The DGI900 multi-reference has many functions. Besides multi-speed, it can be used as the setting source of the V/F separated voltage source and setting source of process PID. In addition, the multi-reference is relative value.

Pb.00~15	Multi-reference 0 to Multi-reference 15	Setting Range: -100.0%~100.0%	0.0%
-----------------	---	---	-------------

Multi-reference can be the setting source of frequency, V/F separated voltage and process PID. The multi-reference is relative value and ranges from -100.0% to 100.0%.

As frequency source, it is a percentage relative to the maximum frequency. As V/F separated voltage source, it is a percentage relative to the rated motor voltage. As process PID setting source, it does not require conversion.

Multi-reference can be switched over based on different states of X terminals. For details, see the descriptions of group P3.

Pb.16	Simple PLC running mode	Setting Range: 0~3	0
--------------	--------------------------------	---------------------------	----------

0 : Stop after the AC drive runs one cycle

The AC drive stops after running one cycle, and will not start up until receiving another command.

1 : Keep final values after the AC drive runs one cycle

The AC drive keeps the final running frequency and direction after running one cycle.

2 : Repeat after the AC drive runs one cycle

The AC drive automatically starts another cycle after running one cycle, and will not stop until receiving the stop command.

Simple PLC can be either the frequency source or V/F separated voltage source.

When simple PLC is used as the frequency source, whether parameter values of Pb.00 to Pb.15 are positive or negative determines the running direction. If the parameter values are negative, it indicates that the AC drive runs in reverse direction. Figure 6-32 Simple PLC when used as frequency source

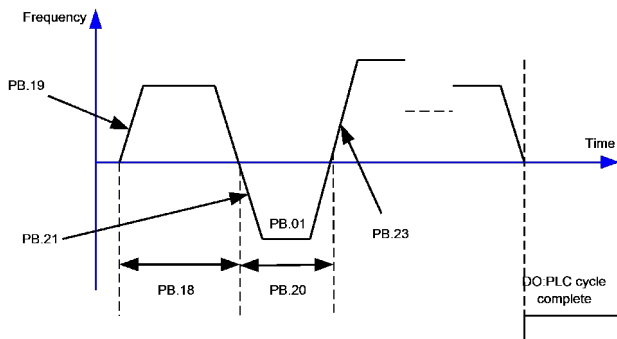

Figure 6-35 Simple PLC when used as frequency source

Pb.17	Simple PLC retentive selection	Setting Range: 00~11	00
-------	--------------------------------	----------------------	----

Unit's digit : Retentive upon power failure ; 0 : NO ; 1 : YES

Ten's digit : Retentive upon stop ; 0 : NO ; 1 : YES

PLC retentive upon power failure indicates that the AC drive memorizes the PLC running moment and running frequency before power failure and will continue to run from the memorized moment after it is powered on again. If the unit's digit is set to 0, the AC drive restarts the PLC process after it is powered on again.

PLC retentive upon stop indicates that the AC drive records the PLC running moment and running frequency upon stop and will continue to run from the recorded moment after it starts up again. If the ten's digit is set to 0, the AC drive restarts the PLC process after it starts up again.

P b.18	Running time of simple PLC reference 0	Setting Range: 0.0s(h)~6553.5s(h)	0.0s(h)
--------	--	-----------------------------------	---------

Pb.19	Acceleration/deceleration time of simple PLC reference 0	Setting Range: 0~3	0
Pb.20~46 (even)	Running time of simple PLC reference n	Setting Range: 0.0s(h)~6553.5s(h)	0.0s(h)
Pb.21~46 (singular)	Acceleration/deceleration time of simple PLC reference n	Setting Range: 0~3	0
P b.48	Running time of simple PLC reference 15	Setting Range: 0.0s(h)~6553.5s(h)	0.0s(h)
Pb.49	Acceleration/deceleration time of simple PLC reference 15	Setting Range: 0~3	0
Pb.50	Time unit of simple PLC running	Setting Range: 0~1	0

0: s(second) ; 1: h(hour)

P b.51	Reference 0 source	Setting Range: 0~5	0
--------	--------------------	--------------------	---

0 : set by PA.00 ; 1 ~ 2: VI、CI ; 4 : PULSE setting ; 5 : PID ; 6 : Set by preset frequency

It determines the setting channel of reference 0. You can perform convenient switchover between the setting channels. When multi-reference or simple PLC is used as frequency source, the switchover between two frequency sources can be realized easily.

6.13 Communication Parameter (Group PC)

Please refer to chapter 9《[YX-9000 RS485 communication protocol](#)》

6.14 Function Code Parameter (Group Pd)

Pd.00	User password	Setting Range:	0
-------	---------------	----------------	---

		0~5555	
--	--	---------------	--

If it is set to any non-zero number, the password protection function is enabled. After a password has been set and taken effect, you must enter the correct password in order to enter the menu. If the entered password is incorrect you cannot view or modify parameters.

If Pd.00 is set to 00000, the previously set user password is cleared, and the password protection function is disabled

Pd.01	Restore default settings	Setting Range: 0~2	0
--------------	---------------------------------	---------------------------	----------

0 : No operation

1 : Restore factory settings except motor parameters

If Pd.01 is set to 1, most function codes are restored to the default settings except motor parameters, frequency reference resolution, fault records, accumulative running time, accumulative power-on time and accumulative power consumption. □

2 : Clear records

If Pd.01 is set to 2, the fault records, accumulative running time, accumulative power-on time and accumulative power consumption are cleared.

Pd.02	AC drive parameter display property	Setting Range: 0~1111	0011
--------------	--	------------------------------	-------------

Unit's digit : Group b display selection 0 : Not display ; 1 : Display

Ten's digit : Group E display selection 0 : Not display ; 1 : Display

Pd.04	Parameter modification property	Setting Range: 0~1	0
--------------	--	---------------------------	----------

It is used to set whether the parameters are modifiable to avoid mal-function. If it is set to 0, all parameters are modifiable. If it is set to 1, all parameters can only be viewed.

6.15 Swing Frequency, Fixed Length and Count (Group PE)

The swing frequency function is applied to the textile and chemical fiber fields and the applications where traversing and winding functions are required.

The swing frequency function indicates that the output frequency of the AC drive swings up and down with the set frequency as the center. The trace of running frequency at the time axis is shown in the following figure.

The swing amplitude is set in PE.00 and PE.01. When PE.01 is set to 0, the swing amplitude is 0 and the swing frequency does not take effect.

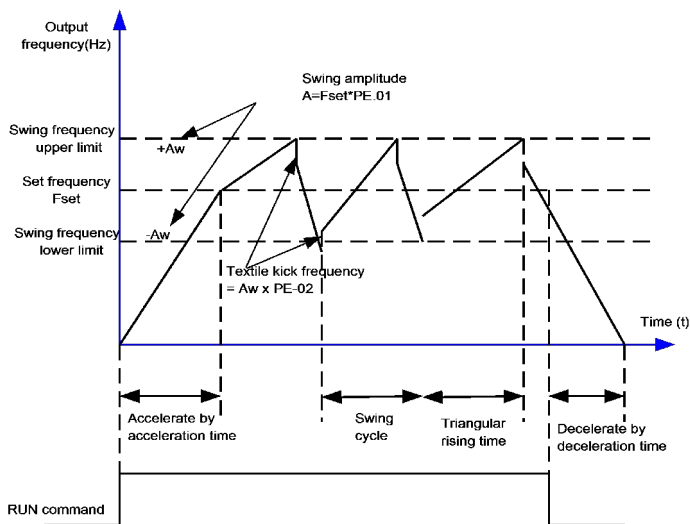

Figure 6-36 Swing frequency control

PE.00	Swing frequency setting mode	Setting Range: 0~1	0
--------------	-------------------------------------	---------------------------	----------

This parameter is used to select the base value of the swing amplitude.

0 : Relative to the central frequency

It is variable swing amplitude system. The swing amplitude varies with the central frequency (set frequency).

1 : Relative to the maximum frequency (PE.04)

It is fixed swing amplitude system. The swing amplitude is fixed.

PE.01	Swing frequency amplitude	Setting Range: 0.0%~100.0%	[0.0%]
PE.02	Jump frequency amplitude	Setting Range: 0.0%~50.0%	[0.0%]

This parameter is used to determine the swing amplitude and jump frequency amplitude. The swing frequency is limited by the frequency upper limit and frequency lower limit.

If relative to the central frequency (PE.00=0), the actual swing amplitude AW is the calculation result of P0.19 (Frequency source selection) multiplied by PE.01.

If relative to the maximum frequency (PE.00=1), the actual swing amplitude AW is the calculation result of PE.04 (Maximum frequency) multiplied by PE.01.

Jump frequency = Swing amplitude AW x PE.02 (Jump frequency amplitude).

If relative to the central frequency (PE.00=0), the jump frequency is a variable value.

If relative to the maximum frequency (PE.00=1), the jump frequency is a fixed value.

The swing frequency is limited by the frequency upper limit and frequency lower limit.

PE.03	Swing frequency cycle	Setting Range: 0.0s~3000.0s	10.0s
PE.04	Triangular wave rising time coefficient	Setting Range: 0.0%~100.0%	50.0%

PE.03 specifies the time of a complete swing frequency cycle.

PE.04 specifies the time percentage of triangular wave rising time to PE.03 (Swing frequency cycle).

Triangular wave rising time = PE.03 (Swing frequency cycle) x PE.04 (Triangular wave rising time coefficient, unit: s)

Triangular wave falling time = PE.03 (Swing frequency cycle) x (1 – PE.04 Triangular wave rising time coefficient, unit: s)

PE.05	Set length	Setting Range: 0m~65535m	1000m
PE.06	Actual length	Setting Range: 0m~65535m	0m
PE.07	Number of pulses per meter	Setting Range: 0.1~6553.5	100.0

The preceding parameters are used for fixed length control.

The length information is collected by X terminals. PE.06 (Actual length) is calculated by dividing the number of pulses collected by the X terminal by PE.07 (Number of pulses each meter).

When the actual length PE.06 exceeds the set length in PE.05, the DO terminal allocated with function 10 (Length reached) becomes ON.\

During the fixed length control, the length reset operation can be performed via the X terminal allocated with function 28. For details, see the descriptions of Group P3.

Allocate corresponding X terminal with function 27 (Length count input) in applications. If the pulse frequency is high, X5/HDI must be used.

PE.08	Set count value	Setting Range: 1~65535	1000
PE.09	Designated count value	Setting Range: 1~65535	1000

The count value needs to be collected by X terminal. Allocate the corresponding X terminal with function 25 (Counter input) in applications. If the pulse frequency is high, X5/HDI must be used.

When the count value reaches the set count value (PE.08), the DO terminal allocated with function 8 (Set count value reached) becomes ON. Then the counter stops counting.

When the counting value reaches the designated counting value (PE.09), the DO terminal allocated with function 9 (Designated count value reached) becomes ON. Then the counter continues to count until the set count value is reached.

PE.09 should be equal to or smaller than PE.08

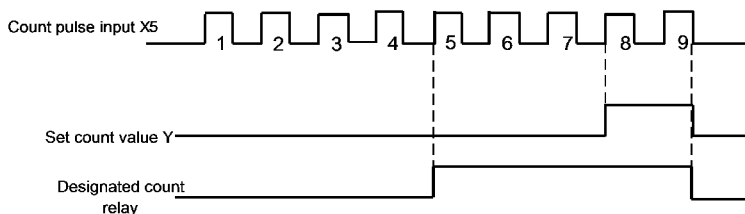

Figure 6-37 Reaching the set count value and designated count value

6.16 AI/AO Correction and AI Curve Setting (Group PF)

PF.00	VI measured voltage 1	Setting Range:	Factory-corrected
--------------	------------------------------	-----------------------	--------------------------

		0.500 V~4.000 V	
PF.01	VI displayed voltage 1	Setting Range: 0.500 V~4.000 V	Factory-corrected
PF.02	VI measured voltage 2	Setting Range: 6.000V~9.999V	Factory-corrected
PF.03	VI displayed voltage 2	Setting Range: 6.000V~9.999V	Factory-corrected

These parameters are used to correct the VI to eliminate the impact of AI zero offset and gain.

They have been corrected upon delivery. When you resume the factory values, these parameters will be restored to the factory-corrected values. Generally, you need not perform correction in the applications.

Measured voltage indicates the actual output voltage value measured by instruments such as the multimeter. Displayed voltage indicates the voltage display value sampled by the AC drive.

During correction, send two voltage values to each AI terminal, and save the measured values and displayed values to the function codes PF.00 to PF.03. Then the AC drive will automatically perform AI zero offset and gain correction.

If the input voltage and the actual voltage sampled by the AC drive are inconsistent, perform correction on site. Take AI as an example. The on-site correction is as follows:

- 1) Send a voltage signal (approximately 2 V) to AI.
- 2) Measure the AI voltage and save it to PF.00.
- 3) View the displayed value of b0.21 and save the value to PF.01.

4) Send a voltage signal (approximately 8 V) to AI.

5) Measure AI voltage and save it to PF.03.

6) View the displayed value of b0.21 and save the value to PF.04.

PF.04	CI measured voltage 1	Setting Range: 0.500 V~4.000 V	Factory-corrected
PF.05	CI displayed voltage 1	Setting Range: 0.500 V~4.000 V	Factory-corrected
PF.06	CI measured voltage 2	Setting Range: 6.000V~9.999V	Factory-corrected
PF.07	CI displayed voltage 2	Setting Range: 6.000V~9.999V	Factory-corrected

These parameter corrected method is the same with PF.00 to PF.03, view the displayed value of b0.22.

PF.12	AO1 target voltage 1	Setting Range: 0.500 V~4.000 V	Factory-corrected
PF.13	AO1 measured voltage 1	Setting Range: 0.500 V~4.000 V	Factory-corrected
PF.14	AO1 target voltage 2	Setting Range: 6.000V~9.999V	Factory-corrected
PF.15	AO1 measured voltage 2	Setting Range: 6.000V~9.999V	Factory-corrected

These parameters are used to correct the AO

They have been corrected upon delivery. When you resume the factory values, these parameters will be restored to the factory-corrected values. Generally, you need not perform correction in the applications.

Measured voltage indicates the actual output voltage value measured by instruments such as the multimeter. Displayed voltage indicates the voltage display value sampled by the AC drive.

PF.16	AO2 target voltage 1	Setting Range: 0.500 V~4.000 V	Factory-corrected
PF.17	AO2 measured voltage 1	Setting Range: 0.500 V~4.000 V	Factory-corrected
PF.18	AO2 target voltage 2	Setting Range: 6.000V~9.999V	Factory-corrected
PF.19	AO2 measured voltage 2	Setting Range: 6.000V~9.999V	Factory-corrected

Corrected method is the same with AO1.

PF.36	Jump point of VI input corresponding setting	Setting Range: -100.0%~100.0%	[0.0%]
PF.37	Jump amplitude of VI input corresponding setting	Setting Range: 0.0%~100.0%	[0.5%]
PF.38	Jump point of CI input corresponding setting	Setting Range: -100.0%~100.0%	[0.0%]
PF.39	Jump amplitude of CI input corresponding setting	Setting Range: 0.0%~100.0%	[0.5%]

The X terminals (CI,VI)of the DGI900 all support the corresponding setting jump function, which fixes the X input corresponding setting at the jump point when X input corresponding setting jumps around the jump range.

For example, AI input voltage jumps around 5.00 V and the jump range is 4.90–5.10 V. AI minimum input 0.00 V corresponds to 0.0% and maximum input 10.00 V corresponds to 100.0%. The detected AI input corresponding setting varies between 49.0% and 51.0%.

If you set PF.36 to 50.0% and PF.37 to 1.0%, then the obtained AI input corresponding setting is fixed to 50.0%, eliminating the fluctuation effect.

6.17 User-Defined Function Codes (Group E0)

E0.00	User-Defined Function Code 0	Setting Range: uP0.00~ub0.xx	P0.00
E0.01 ~ A2.30	User-Defined Function Code 01 to 30	Setting Range: uP0.00~ub0.xx	P0.01
E0.31	User-Defined Function Code 31	Setting Range: uP0.00~ub0.xx	P0.02

Group E0 is user-defined parameter group. You can select the required parameters from all DGI900 functions codes and add them into this group, convenient for view and modification.

Group E0 provides a maximum of 32 user-defined parameters. If "uP0.00" is displayed, it indicates that group E0 is null. After you enter user-defined function code mode, the displayed parameters are defined by E0.00 to E0.31 and the sequence is consistent with that in group E0.

6.18 Motor 2 to Motor 4 Parameters (Group E3, E4, E5)

Motor 2 parameters E3.00 to E3.37 in group E3 are the same with P8.00~P8.37, while

E3.38 to E3.55 is same with P9.01to P9.18.

Motor 3 parameters E4.00 to E4.37 in group are the same with P8.00 to P8.37, while E4.38 to E4.55 is same with P9.01 to P9.18.

Motor 4 parameters E5.00 to E5.37 in group E5 are the same with P8.00 to P8.37, while E5.38 to E5.55 is same with P9.01to P9.18.

6.19 Standard Monitoring Parameters (Group b0)

Group b0 is used to monitor the AC drive's running state. You can view the parameter details description in chapter 5(Group b0).

Chapter 7 Troubleshooting

7.1 Fault Alarm and Troubleshooting

When inverter trips, protection function acts as LED displays fault code, fault relay acts, inverter output stops and motor coasts to stop. DGI900 series inverter's fault contents and troubleshooting are shown in Table 7-1. After fault alarm occurs, inverter should be inspected according to Table 7-1. When technical assistance required, please contact your supplier.

Table 7-1 Alarms and troubleshooting

Fault code	Type of faults	Possible fault reasons	Troubleshooting
E-01	Acc over current	Acc time is short	Adjust acc time
		V/F curve setup is not suitable	Adjust V/F curve
		Restart the motor in running	Setup start mode as speed tracking
		Torque boost setup is big	Adjust torque boost or set as auto
		Inverter power is small	Select inverter with proper capacity
E-02	Dec over current	Dec time is short	Adjust Dec time
		Potential load or load inertia is big	Add suitable braking device
		Inverter power is small	Select inverter with proper capacity
E-03	Over current at constant speed running	Load mutation	Check load
		Acc or Dec time is short	Adjust Acc or Dec time
		Input voltage abnormal	Check input power supply
		Load abnormal	check load
		Inverter power is small	Select inverter with proper capacity
E-04	Acc overvoltage	Input voltage abnormal	Check input power supply
		Acc time is too short	Adjust Acc time
		Restart the motor in running	Setup start mode as speed tracking

Fault code	Type of faults	Possible fault reasons	Troubleshooting
E-05	Dec overvoltage	Dec time is short	Adjust the Dec time
		Potential load or load inertia is big	Add suitable braking device
E-06	Overvoltage at constant speed running	Input voltage abnormal	Check input power supply
		Acc or Dec time is short	Adjust the Acc or Dec time
		Abnormal change of input voltage	Mount input reactor
		Load inertia is big	Add suitable braking device
E-07	Reserved	---	---
E-08	Inverter overheat	Air duct obstruction	Clean air duct
		Environment temperature is high	Improve the ventilation or decrease the carrier frequency
		Fan damaged	Replace a new fan
		Inverter module abnormal	Contact supplier
E-09	Inverter overload	Acc time is short	Adjust Acc time
		DC braking value is high	Decrease DC braking current and increase braking time
		V/F curve setup is not suitable	Adjust V/F curve
		Restart the motor in running	Setup start mode as speed tracking restart
		Grid voltage is low	Check grid voltage
		heavy load	Select inverter with proper capacity
E-10	Motor overload	V/F curve setup is not suitable	Adjust V/F curve
		Grid voltage is low	Check grid voltage
		General motor runs at low speed with heavy load for long	Use a special motor for long term running

		Wrong setting of motor overload protection factor	Set the factor right
		Motor chocked or sudden change of load	Check load
E-11	Under voltage in running	Grid voltage is low	Check grid voltage
E-12	Output lack phases	Cable between Inverter and motor is fault	Check the peripheral fault
		Output 3-phases un balance	Check motor 3 phases winding
		Drive board fault	Contact supplier
		IGBT module fault	Contact supplier
		Control board connecting wire or plug-in unit loose	Check and re-wiring
E-13	Peripheral fault	External fault terminals closed	Check the reason
E-14	Current detecting circuit fault	Loose wiring or terminal connections	Check and re-wiring
		Auxiliary power source damaged	Contact supplier
		Hall component damaged	Contact supplier
		Amplifier circuit abnormal	Contact supplier
E-15	RS232/485 communication fault	Baud rate setting incorrect	Set baud rate properly
		Serial port communication fault	Press  Key to reset or contact supplier
		Improper fault alarm parameter setting	Revise function code PC group

		Upper computer doesn't work	Check upper computer and connecting cable
E-16	STOP m interference	Serious interference	Press key to reset or install input power source filter
		DSP read/write error	Reset or contact supplier
E-17	STOP ROM error	Read/write error of control parameter	press key to reset or install input power source filter
E-18	Motor STOP eter over current fault	Power range of Motor and inverter do not match	Contact supplier press key to reset
E-19	STOP hase loss protection	One of R, S, T port has no voltage	Press key to reset check voltage of R, S, T
E-20	Reserved	---	---
E-21	Encorder fault	Encorder not matched	Select right model of Encorder
		Encorder wiring incorrect	Check wiring
		Encorder damaged	Replace encorder
		PG card fault	Replace PG card
E-22	Input Power fault	Input power out of range	Use proper power supply
E-23	Runing time completed	Running time reach setting value	Clear record
E-24	Power on time completed	Power on time reach setting value	Clear record

E-25	Motors switch over fault during running	Change the selection of the motor via terminal during running of Inverter	Perform motor switchover after inverter stops.
E-26	Wave limiting current	Load heavy or motor blocked	Reduce load or check mechanical status
		Inverter power small	Select big rating inverter
E-27	Motor over heat fault	Temperature sensor wiring loose	Check sensor wiring
		Motor temperature high	Reduce carrier frequency or adopt other heat radiation measure.
E-28	large speed deviation	The encoder parameters are set incorrectly.	Set the encoder parameters properly.
		Auto-tuning is not performed.	Perform the motor autotuning.
		PA65、PA66 setting is improper	Set PA65 and PA66 correctly based on the actual situation.
E-29	Motor over speed fault	Encoder parameter setting incorrect	Set the encoder parameter properly
		Auto-tuning is not performed	Perform motor autotuning
		Motor speed inspection parameter PA63 and PA64 setting is incorrect	Set inspection parameter as actual
E-30	Load drop	Inverter running current is lower than PA60	Check the load disconnected or the setting of PA60 and PA61
E-31	PID feedback loss	PID feedback value less than P6.26 setting value	Check PID feedback signal or set P6.26 properly

E-32	User defined fault 1	Input user defined fault 1 signal via multi-function terminal X	Reset
E-33	User defined fault 2	Input user defined fault 2 signal via multi-function terminal X	Reset
E-34	Contactor fault	Drive board or power supply is abnormal	Change drive board or power supply
		Contactor is abnormal	Change contactor
E-35	Short circuit to ground fault	Motor short circuit to ground	Change motor or cable

7.2 Fault Record Search

Inverter record the fault codes occurred in the last 3 times. The fault information is reserved in PA group. Enter PA parameter group by Keypad operation

7.3 Fault Reset

When fault occurred, please select the following methods to recover:

- (1) When fault code is displayed, after ensure it can be reset, press  to reset.
- (2) Set one of X1~X8 terminal as external RESET input (P3.00~P3.09=9).
- (3) Cut off power.

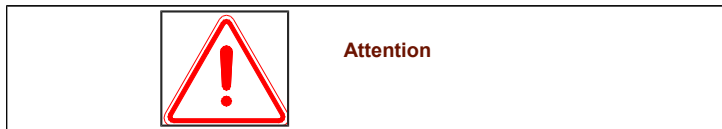

- (1) Reset the inverter after thoroughly investigating the cause of fault and clearing, otherwise, the inverter may be damaged.
- (2) If it can't be reseted or fault occurs again after reset, please check the cause of fault, continuous reset may damage inverter.
- (3) Reset the inverter after waiting for 5min when overload or overheat protection occurs.

Chapter 8 Preservation and Maintenance

8.1 Preservation and Maintenance

Potential hazards exist due to aging, wear and tear of inverter internal components as well as environmental influences to the inverter, such as temperature, humidity particles etc.. Therefore, daily inspection, periodic preservation and maintenance must be performed to the inverter and its driving mechanism during their storage and operation.

Daily Maintenance

The following must be verified before starting up :

- (1) No abnormal vibration and no abnormal noise.
- (2) No abnormal heat.
- (3) No abnormal ambient temperature.
- (4) The ammeter satisfy the specification

(5) Fan is working in good condition

8.2 Periodic Preservation and Maintenance

8.2.1 Periodic Maintenance

Cut off the power when inverter is maintained thermally, check after the main circuit power indicator light is off. The checking content is shown in Table 8-1.

Table 8-1 Periodic inspections

Checking item	Checking content	Troubleshooting
Screws of control terminals and main circuit terminals	The screws are loose or not	If loose, tighten them with screw driver
Heat sink	Whether there is dust	Clean thoroughly the dust
Printed circuit board	Whether there is dust	Clean thoroughly the dust
Cooling fans	Whether there is abnormal vibration or abnormal noise	Replace cooling fans
Power element	Whether there is dust	Clean thoroughly the dust
Electrolytic capacitor	Whether there is discoloring, peculiar smell	Replace electrolytic capacitor

8.2.2 Thermally maintaining

In order to let inverter work well for a long term, user must maintain the inverter thermally. The replace time of element of inverter is shown in Table 8-2.

Table 8-2 frequency inverter parts replacement

Items	Time criterion
Cooling fans	2-3 years

Electrolytic capacitors	4-5 years
Printed circuit board	5-8 years
Fuse	10 years

The working condition of the inverter as following:

- (1) Environment temperature: average 30C.
- (2) Load coefficient: under 80%.
- (3) Running time: under 12 hour everyday.

8.3 Warranty of Inverter

Our company supply warranty in the following condition:

- (1) Only inverter in the warranty range.
- (2) In the normal using, inverter damaged in 15 month. Over 15 month, our company will charge for the repair service.
- (3) In the following condition in 15 month, our company also will charge for the repair service:
 - Inverter is damaged caused by user not complying with instructions.
 - Inverter is damaged caused by fire, flood, and abnormal voltage.
 - Inverter is damaged caused by wrong wiring.
 - Inverter is damaged when it is used in the abnormal applications.
- (4) Service charge will be calculated with reference to actual cost, but if included in the contract, then according to the contract.

Chapter 9 Serial port RS485 communication protocol

9.1 Communication overview

Our series of inverters provide users with a common industrial control RS485

communication interface, in which The MODBUS standard protocol is used for communication. The inverters can be used as slave connected to the host (such as PLC controller, PC), both of which have the same communication interface and protocol, for the purpose of centralized monitoring of the inverters. Or one inverter can be used as host and other inverters as slaves, all connected with RS485 communication interface, to achieve multi-machine interaction of the inverters. And with this communication interface, a Keyboard can also be connected to inverters for remote operation.

The MODBUS communication protocol of the inverter supports two transmitting ways: RTU mode, the following is a detailed description of the communication protocol of the inverter.

9.2 Communication protocol specification

9.2.1 Communications networking methods

1. networking methods with inverter as slave:

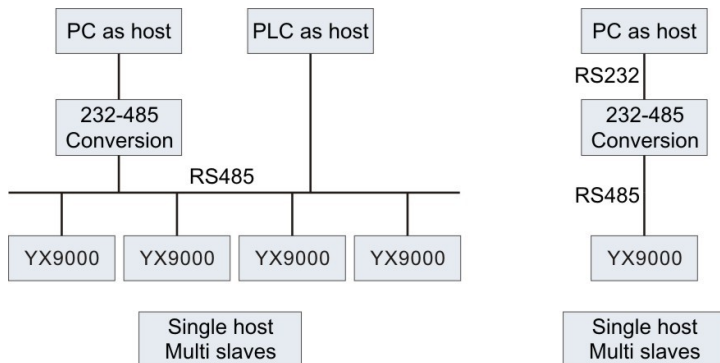

Fig. 9 – 1 networking of slaves

- (2) The networking of multi-machine interaction :

Fig. The networking of multi-machine interaction

9.2.2 Communication protocol

The inverter can either be used as a host or slave in RS485 network. It can be used for controlling our other inverters as host to achieve multi-level linkage, or controlled by host (PC or PLC) as a slave. The specific communication mode as follows:

- 1) Inverter is used as slave, in point-to-point communication of master-slave mode. Host sends commands from broadcast address, while slave doesn't answer.
- 2) Inverter is used as host, sending commands from broadcast address, while slave doesn't answer.
- 3) The address, baud rate and data format of the inverter can be setup by using the keyboard or the serial communication.
- 4) message of error is reported by slave, in the recent response frame against host polling

9.2.3 Communication Interface

The communication is using RS485 interface, with asynchronous serial and half-duplex transmission. The default communication protocol is in RTU mode.

The default data format: 1 start bit, 7 data bits, 2 stop bits.

The default rate is 9600bps. Communication parameter settings reference P3.09 ~ P3.12 function code.

9.3 RTU protocol

Character structure:

11 characters box (For RTU)

(1-8-2 format, no parity)

Start	1	2	3	4	5	6	7	Stop	Stop
-------	---	---	---	---	---	---	---	------	------

bit									bit	bit
-----	--	--	--	--	--	--	--	--	-----	-----

(1-8-1 format, odd parity)

Start bit	1	2	3	4	5	6	7	Odd parity	Stop bit
-----------	---	---	---	---	---	---	---	------------	----------

(1-8-1 format, even parity)

Start bit	1	2	3	4	5	6	7	Even parity	Stop bit
-----------	---	---	---	---	---	---	---	-------------	----------

Communications data structures

RTU mode :

START	Maintaining no input signal for more than or equal to 10ms
Address	address : 8-bit Binary address
Function	Function code : 8-bit Binary address
DATA (n - 1)	Data content : N*8-bit data, N<=8, less than 8 bytes
.....	
DATA 0	
CRC CHK Low	CRC Check code
CRC CHK High	16-bit CRC check code is combined with 2 8-bit Binary code
END	Maintaining no input signal for more than or equal to 10ms

The most important function of Modbus is to read and write parameters. Different function codes determine different operation requests. Inverter Modbus protocol supports the following function code operation:

function code	Function code meaning
0x03	Read inverter function code parameters and operating status parameters
0x06	Rewrite the inverter's single function code or control parameters, do not save after power down
0x07	Rewrite the inverter's single function code or control parameters, save after power down

The function code, control and status parameters of the inverter are all mapped as Modbus read and write registers. Read and write features and ranges of function code parameters follow the instructions of the inverter user manual. The control and status parameters of the inverter are separately assigned addresses.

Correspondence between the function code group number and its mapped high byte Address under:

Address is 0x00~0x0F, corresponding function code is Group P0~PF, Address is 0x10~0x1F, corresponding function code is Group E0~EF, Address is 0x20~0x2F, corresponding function code is Group F0~FF, Address is 0x30~0x3F, corresponding function code is Group d0~dF, Address is 0x40~0x4F, corresponding function code is Group c0~cF, address is 0x500x, the inverter status parameter read address: address is 0x600x, inverter control parameter group address: address is 0x8000, inverter fault status address: address is 0x8001, inverter communication error address:

Inverter status parameter address	Order content	Inverter status Parameter address	Order content
0x5000	Communication given frequency -10000 ~1000	0x5011	PID feedback

	(Decimal)		
0x5001	Operating frequency	0x5012	PLC steps
0x5002	bus voltage	0x5013	PULSE Input pulse frequency, unit 0.01KHz
0x5003	output voltage	0x5014	Feedback speed, unit 0.1Hz
0x5004	Output current	0x5015	Remaining runtime
0x5005	Output power	0x5016	All sampling voltage
0x5006	Output torque	0x5017	AI2 sampling voltage
0x5007	Performance feedback frequency	0x5018	AI3 sampling voltage
0x5008	DI input status	0x5019	Line speed
0x5009	DO output status	0x501A	current power-on time
0x500A	All corrected voltage	0x501B	current running time
0x500B	AI2 corrected voltage	0x501C	PULSE Input pulse frequency in 1Hz
0x500C	AI3 corrected voltage	0x501D	Encoder feedback speed 0.01Hz
0x500D	Count value input	0x501E	Actual feedback speed
0x500E	length value input	0x501F	Main frequency X display
0x500F	Load speed	0x5020	Auxiliary frequency Y display
0x5010	PID setting		

Control command address :

Control word address	Order content	Control word address	Order content
0x6000 (control command word address)	0001:Forward running	0x6001(Communication control analog AO1 output address)	0x0~0x7FFF
	0002:Reverse running		0x0~0x7FFF
	0003:Positive rotation	0x6003(Communication DO output address)	BIT0:DO1 output control
	0004:Reverse jogging		BIT1:DO2 output control
	0005:Deceleration stop		BIT2:Relay 1
	0006:Free downtime		BIT3:Relay 2
	0007:Fault reset		BIT4:HDO as normal DO output
0x6004(HDO pulse output system)	0x0~0x7FFF		Other bits: Reserved

Note:

Communication setting is a percentage of relative value, 10000 corresponds to 100.00%, -10000 corresponds to -100.00%.

For frequency dimension data, the percentage is a percentage of the maximum frequency (P 0.05); for torque dimension data, the percentage is P9.26 (torque ceiling digital setting).

AO and HDO output 0x0 ~ 0x7FFF, respectively, with 0% to 100%.

Inverter fault addresses	Inverter fault information	Inverter fault address	Inverter fault information
0x8000	0000: no fault	0x8000	0012:Motor parameter over current fault
	0001:Acc overcurrent		0013 : Input phase loss protection
	0002:Dec overcurrent		0014 : Earthing short circuit fault
	0003:Over current at constant speed running		0015 : Encoder fault
	0004:acc overvoltage		0016 : Input Power fault
	0005:Dec overvoltage		0017 : Running time completed fault
	0006:Overvoltage at constant speed running		0018 : Power on time completed fault
	0007:Contactor fault		0019 : Motors switch over fault during running
	0008:Inverter overheat		001A:Motor over heat fault
	0009:Inverter overload		001B:large speed deviation
	000A:Motor overload		001C:Motor over speed fault
	000B:Under voltage in running		001D: Load drop
	000C:Output lack phase		001E:PID feedback loss

	000D:Peripheral fault		001F:User defined fault 1
	000E : Current detecting circuit fault		0028 : User defined fault 2
	000F : RS232/485 Communication fault		0029 : PID feedback loss
	0010 : System interference		002A:User defined fault 1
	0011 : EP2PPROM error		002B:User defined fault 2

Note:

The inverter fault information read from the fault address is consistent with the fault record code in Table 7-1 in Chapter 7.

If the operation request fails, the response is the error code and the exception code. The address is 0x8001 the meaning of the exception code is as follows:

Abnormal code	Abnormal code meaning	Abnormal code	Abnormal code meaning
0x0001	wrong password	0x0005	Illegal data, operating data is not within the upper and lower limits
0x0002	Read and write command error	0x0006	Parameter read-only, does not allow changes
0x0003	CRC check error	0x0007	Read and write failed, factory parameters are not allowed to operate
0x0004	Illegal address, operation address error	0x0008	Parameter does not allow changes

CRC check

Taking into account the need to improve speed, CRC-16 is usually achieved using the form,

the following is to achieve CRC-16 C language source code, pay attention to the final result has been exchanged high and low byte, that is, the result is to send the CRC checksum .

```
uint16 CrcValueByteCaA0(const uint16 *data, uint16 len)
```

```
{
    uint16 CRCValue = 0xFFFF;
    uint16 tmp;
    uint16 a;
    while (len--)
    {
        tmp = *(data++);
        a = (CRCValue ^ tmp) & 0x000F;
        CRCValue >>= 4;
        CRCValue ^= crc16Table[a];
        a = (CRCValue & 0x000F) ^ (tmp >> 4);
        CRCValue >>= 4;
        CRCValue ^= crc16Table[a];
    } return crcValue;
}
```

Application examples

Read command frame: The request frame is to read two consecutive parameter values from P0.02 function code of No.1 engine.

address	Order code	Register		Number of bytes of		Checksum
		address		operation		
0x01	0x03	0x00	0x02	0x00	0x02	To be calculated

Read command response frame:

address	Order code	Number of data sections	P0.02 Data content		P0.03 Data content		Checksum
0x01	0x03	0x04 (2*2)	0x13	0x88	0x00	0x00	To be calculated

Write command frame: Request frame is write data frame of P0.02 parameter of machine number 1:

address	Order code	Register address		Write the value		Checksum
0x01	0x06	0x00	0x02	0x13	0x88	To be calculated

Write command response frame:

address	Order code	Register address		Write the value		Checksum
0x01	0x06	0x00	0x02	0x13	0x88	To be calculated

Write command frame: Unit 1 is running forward start (P0.03 need to be set to 2)

address	Order code	Register address		Write the value		Checksum
0x01	0x06	0x60	0x00	0x00	0x01	To be calculated

Parameter Description

PC.00	Baud rate	Range: 0~9	6
-------	-----------	------------	---

0: 300BPS;

1: 600BPS;

2: 1200BPS;

3: 2400BPS;

- 4: 4800BPS;
- 5: 9600BPS;
- 6: 19200BPS;
- 7: 38400BPS;
- 8: 57600BPS;
- 9: 115200BPS.

This parameter is used to set the data transmission rate between host computer and inverter. Note that the host computer and the inverter set the baud rate must be the same, Otherwise, communication will not work.

PC.01	Data Format	Range: 0~3	0
-------	-------------	------------	---

- 0 : No parity: data format <8,N,2>;
- 1 : Even check = data format <8,E,1>;
- 2 : Odd parity = data format<8, 0,1>;
- 3 : No parity, data format<8-N-l>.

This parameter must be consistent with the host computer, or can not communicate.

PC.02	Local address	Range: 1~247	1
-------	---------------	--------------	---

When the local address is set to 0, that is broadcast address, to achieve PC broadcast function.

The uniqueness of the local address (in addition to broadcast address sunset, which is to achieve PC and inverter peer-to-peer communications.

PC.03	Response delay	Range: 0~20ms	2ms
-------	----------------	---------------	-----

Response delay: refers to the inverter data reception to the host computer to send data to the middle of the interval. If the response delay is less than the system processing time, the response delay is based on the system processing time. If the response delay is longer than

the system processing time, the system delays the processing after the data is processed until the response delay time arrives. Send data.

PC.04	Communication timeout	Range: 0.0s~60.0s	【0.0s】
-------	--------------------------	-------------------	---------------

When this function code is set to 0.0 s, the communication timeout parameter is invalid.

When this function code is set as valid value, if the interval time between one communication and the next communication exceeds the communication timeout, the system will report a communication error (E-15 will be set to invalid normally.) If the function of continuous communication of the system, set the secondary parameters, you can monitor the communication status.

PC.05	Read data return format selection	Range: 0~1	【0】
-------	--------------------------------------	------------	------------

0: return data is 2 bytes high and low 8 bits:

1: return data bit 1 byte.