

User Manual

DGI300 Sensorless Vector Type Inverter



The logo for degdrive, featuring three horizontal grey bars to the left of the word 'degdrive' in a bold, sans-serif font. The 'deg' is in orange and 'drive' is in grey. A registered trademark symbol (®) is located at the top right of the 'e' in 'drive'.

Preface

Thank you for choosing DGI300 of DEGDRIVE .

DGI300 series vector control inverter is mainly positioned as a high-end market for OEM customers and the specific requirements of fan and pump load applications, its flexible design, both embedded SVC and VF control in one, can be widely used for speed control accuracy, torque response speed, low-frequency output characteristics and other situations with higher requirements.

This user manual supplies a detailed description of DGI300 series vector control inverter includes product characterization, structural features, parameter setting, operation and commissioning, inspection maintenance and other contents. Be sure to carefully read through the safety precautions before use, and use this product on the premise that personnel and equipment safety is ensured.

IMPORTANT NOTES

- ◆ To illustrate the details of the products, pictures in this manual based on products with outer casing or safety cover being removed. When using this product, please be sure to well install outer casing or covering by the rules, and operating in accordance with the manual contents.
- ◆ The illustrations this manual for illustration only and may vary with different products you have ordered.
- ◆ The company is committed to continuous improvement of products, product features will continue to upgrade, and the information provided is subject to change without notice.
- ◆ If you are using have questions; please contact our regional agents or our customer service center.

Customer Service Tel: 0212 451 56 05.

Customer Service mobile: +90 533 775 60 66.

- ◆ The company's other products please visit our website. <http://www.degdrive.com>

Contents

Chapter 1 Safety Precautions

1.1 Safety Considerations	(4)
1.2 Precaution	(8)

Chapter 2 Models and Specifications

2.1 Models	(12)
2.2 Specifications	(13)
2.3 Parts of Inverter	(16)
2.4 Dimensions	(17)
2.5 Optional Parts.....	(24)

Chapter 3 Installation and Wire Connection

3.1 Installation	(27)
3.2 Removing and Mounting Front Cover of Inverter.....	(28)
3.3 Wire Connection	(28)
3.4 Main Circuit Wiring	(29)
3.5 Basic Wiring Diagram	(31)
3.6 Control Circuit Terminal Wiring	(32)
3.7 EMC Installation Instruction	(39)

Chapter 4 Running of Inverter

4.1 Running of Inverter	(42)
4.2 Operation and Using of the Control Panel.....	(45)
4.3 Inverter power.....	(53)

Chapter5 Function Parameter Table

5.1 Symbol Description	(55)
5.2 Function Code Table	(55)

5.3 State Monitoring Parameter Table-----	(73)
5.4 Terminal Monitoring State-----	(74)

Chapter 6 Function Code Description

6.1 Basic running function parameter (P0 Group) -----	(75)
6.2 Frequency Setting Function Parameter (P1 Group)--	----- (83)
6.3 Start/Brake Function Parameter (P2 Group)-----	(86)
6.4 Auxiliary Running Parameter (P3 Group)-----	(88)
6.5 Terminal Control Function Parameter (P4 Group)-----	----- (97)
6.6 Protection Function Parameter (P5 Group)-----	----- (113)
6.7 Fault Record Function Parameter (P6 Group)-----	(116)
6.8 Close Loop Running Control Function Parameter (P7 Group)--	----- (117)
6.9 PLC Running Parameter (P8 Group)-----	(125)
6.10 Swing Frequency Function Parameter (P9 Group)-----	----- (130)
6.11 Vector Control Parameter (PA Group)-----	(135)
6.12 Factory Function Parameter (PF Group)-----	(136)

Chapter 7 Troubleshooting

7.1 Fault Alarm and Troubleshooting -----	(137)
7.2 Fault Record Search-----	(141)
7.3 Fault Reset -----	(141)

Chapter 8 Preservation and Maintenance

8.1 Preservation and Maintenance -----	(142)
8.2 Periodic Preservation and Maintenance-----	(142)
8.3 Warranty of Inverter-----	(143)

Chapter 9 Serial Port Communication Protocol of RS485

9.1 Communication Overview-----	(144)
9.2 Communication Protocol Specification-----	(144)
9.3 The ASCII Communication Protocol-----	(146)

Chapter 1 Safety Precautions

Safety Precautions

Safety signs in this manual:



DANGER: indicates the situation in which the failure to follow operating requirements may result in fire or serious personal injury or even death.







CAUTION: indicates the situation in which the failure to follow operating requirements may cause moderate or slight injury and damage to equipment.





Users are requested to read this chapter carefully when installing, commissioning and repairing this product and perform the operation according to safety precautions as set forth in this chapter without fail. DEGDRIVE will bear no responsibility for any injury and loss as a result of any violation operation.

1.1 Safety Considerations

The use phase	Safety class	Considerations
Before Installation	 Danger	<ul style="list-style-type: none"> ◆ Do not install the product if the package is with water, or component is missing or broken. ◆ Do not install the product if the label on the package is not identical to that on the inverter.
	 Caution	<ul style="list-style-type: none"> ◆ Be careful of carrying or transportation. Risk of devices damage. ◆ Do not use damaged product or the inverters

		<p>missing component .Risk of injury.</p> <ul style="list-style-type: none"> ◆ Do not touch the parts of control system with bare hands. Risk of ESD hazard.
Installation	 Danger	<ul style="list-style-type: none"> ◆ Installation base shall be metal or other non-flammable material. Risk of fire. ◆ Do not install inverter in an environment containing explosive gases, otherwise there is danger of explosion. ◆ Do not unscrew the fixing bolts, especially the bolts with red mark.
	 Caution	<ul style="list-style-type: none"> ◆ Do not leave cable strips or screws in the inverter. Risk of inverter damage. ◆ Install the product at the place with less vibration and no direct sunlight. ◆ Consider the installation space for cooling purpose when two or more inverters are placed in the same cabinet.
Wiring	 Danger	<ul style="list-style-type: none"> ◆ Wiring must be performed by authorized and qualified personnel. Risk of danger. ◆ Circuit-breaker should be installed between inverter and the mains. Risk of fire. ◆ Make sure the input power supply has been completely disconnected before wiring. Failure to comply may result in personnel injury and/or equipment damage. ◆ Since overall leakage current of this equipment may be bigger than 3.5mA, for safety's sake, this

		<p>equipment and its associated motor must be well grounded so as to avoid risk of electric shock.</p> <ul style="list-style-type: none"> ◆ Never connect the power cables to the output terminals (U,V,W) of the AC drive. Pay attention to the marks of the wiring terminals and ensure correct wiring. Failure to comply will result in damage to the AC drive. ◆ Install braking resistors at terminals (P+) and (P- or PB) only. Failure to comply may result in equipment damage.
	<p style="text-align: center;"> Caution</p>	<ul style="list-style-type: none"> ◆ Since all adjustable frequency AC drives from DEGDRIVE have been subjected to hi-pot test before delivery, users are prohibited from implementing such a test on this equipment. Failure to comply may result in equipment damage. ◆ Signal wires should to the best of the possibility be away from main power lines. If this cannot be ensured, vertical cross-arrangement shall be implemented, otherwise interference noise to control signal may occur. ◆ If motor cables are longer than 100m, it is recommended output AC reactor be used. Failure to comply may result in faults.
Before	<p style="text-align: center;"></p>	<ul style="list-style-type: none"> ◆ Inverter shall be power-on only after the front

Power-on	Danger	cover is assembled. Risk of electrical hazard.
	 Caution	<ul style="list-style-type: none"> ◆ Verify that the input voltage is identical to the rated voltage of product, correct wiring of input terminals R, S, T or L1, L2 and output terminals U, V, and W, wiring of inverter and its peripheral circuits, and all wires should be in good connection. Risk of inverter damage.
After Power-on	 Danger	<ul style="list-style-type: none"> ◆ Do not open the cover after power. Risk of electrical hazard. ◆ Do not touches any input/output terminals of inverter with bare hands. Risk of electrical hazard.
	 Caution	<ul style="list-style-type: none"> ◆ If auto tuning is required, be careful of personal injury when motor is running. Risk of accident. ◆ Do not change the defaults of parameters. Risk of devices damage.
During Operation	 Danger	<ul style="list-style-type: none"> ◆ Non-professionals shall not detect signals during operation. Risk of personal injury or device damage. ◆ Do not touch the fan or the discharging resistor to check the temperature. Failure to comply will result in personal burnt.
	 Caution	<ul style="list-style-type: none"> ◆ Prevent any foreign items from being left in the devices during operation. Risk of device damage. ◆ Do not control start/stop of inverter by ON/OFF of contactor. Risk of device damage.

Maintenance	 Danger	<ul style="list-style-type: none"> ◆ Maintenance and inspection can only be performed by professionals. Risk of personal injury. ◆ Maintain and inspect devices after power is off. Risk of electric hazard. ◆ Repair or maintain the AC drive only ten minutes after the AC drive is powered off. This allows for the residual voltage in the capacitor to discharge to a safe value. Failure to comply will result in personal injury. ◆ All pluggable components can be inserted or pulled out only when power has been turned off. ◆ Set and check the parameters again after the AC drive is replaced.
-------------	---	--

1.2 Precautions

1.2.1 Motor Insulation Inspection

When the motor is used for the first time or when the motor is reused after being kept, or when periodical inspection is performed, insulation inspection shall be conducted with motor so as to avoid damaging the inverter because of the insulation failure of the motor windings. The motor wires must be disconnected from the inverter during the insulation inspection. It is recommended to use the 500V mega meter, and the insulating resistance measured shall be 5M Ω at least..

1.2.2 Motor Thermal Protection

If the motor rating does not match that of the inverter, especially when the rated power of the inverter is higher than that of the motor, adjust motor protection parameters in the inverter or install thermal relay to protect motor.

1.2.3 Operating with the Frequency Higher than Grid Power Frequency

Output frequency of DGI300 is 0.00Hz~500Hz. If DGI300 is required to operate above 50.00Hz, please take the endurance of mechanical devices into consideration.

1.2.4 Mechanical Vibrations

Inverter may encounter mechanical resonance point of the load device at certain output frequencies which can be avoided by setting the skip frequency parameters of the inverter.

1.2.5 Motor Heat and Noise

Since output voltage of inverter is PWM wave and contains a certain amount of harmonics, so that the temperature, noise and vibration of the motor will be higher than those when the inverter runs at grid power frequency.

1.2.6 Voltage-sensitive device or capacitor on output side of the AC drive

Do not install the capacitor for improving power factor or lightning protection voltage-sensitive resistor on the output side of the AC drive because the output of the AC drive is PWM wave. Otherwise, the AC drive may suffer transient overcurrent or even be damaged.

1.2.7 Contactor at the I/O terminal of the AC drive

When a contactor is installed between the input side of the AC drive and the power supply, the AC drive must not be started or stopped by switching the contactor on or off. If the AC drive has to be operated by the contactor, ensure that the time interval between switching is at least one hour since frequent charge and discharge will shorten the service life of the capacitor inside the AC drive.

When a contactor is installed between the output side of the AC drive and the motor, do not

turn off the contactor when the AC drive is active. Otherwise, modules inside the AC drive may be damaged.

1.2.8 Applied with the Rated Voltage

Apply DGI300 with the rated voltage. Failure to comply will damage inverter. If required, take a transformer to boost or step-down voltage.

1.2.9 Do Not Apply a 3-Phase Input Inverter to 2-Phase Input Applications

Do not apply a 3-phase input FR inverter to 2-phase input applications. Otherwise, it will result in faults or damage inverter.

1.2.10 Lightning Protection

DGI300 has integrated lightning over-current protection device which has certain self-protection capacity against the lightning. Additional protection devices have to be installed between inverter and power supply in the area where lightning occurs frequently.

1.2.11 Altitude De-rating

In places where the altitude is above 1000 m and the cooling effect reduces due to thin air, it is necessary to de-rate the AC drive. Contact DEGDRIVE for technical support.

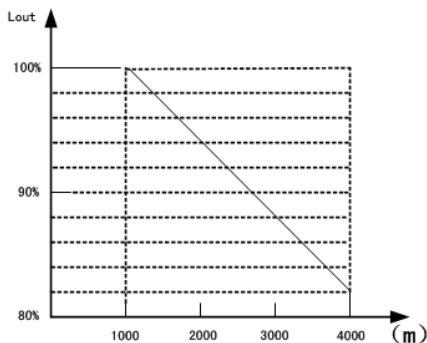

1.2.12 some special usages

If wiring that is not described in this manual such as common DC bus is applied, contact the

agent or DEGDRIVE for technical support.

1.2.13 Cautions for Inverter Disposal

The electrolytic capacitors on the main circuit and PCBA may explode when they are burnt. Emission of toxic gas may be generated when the plastic parts are burnt. Please dispose inverter as industrial wastes.

1.2.14 Adaptable Motor

The standard adaptable motor is adaptable four-pole squirrel-cage asynchronous induction motor or PMSM. For other types of motor, select a proper AC drive according to the rated motor current.

The cooling fan and rotor shaft of non-variable-frequency motor are coaxial, which results in reduced cooling effect when the rotational speed declines. If variable speed is required, add a more powerful fan or replace it with variable-frequency motor in applications where the motor overheats easily.

The standard parameters of the adaptable motor have been configured inside the AC drive. It is still necessary to perform motor auto-tuning or modify the default values based on actual conditions. Otherwise, the running result and protection performance will be affected.

The AC drive may alarm or even be damaged when short-circuit exists on cables or inside the motor. Therefore, perform insulation short-circuit test when the motor and cables are newly installed or during routine maintenance. During the test, make sure that the AC drive is disconnected from the tested parts.

Chapter 2 Models and Specifications

2.1 Models

DGI300 series inverter has 2 kinds of voltage levels, 220V and 380V. The Power range is from 0.4KW to 450KW. Models of DGI300 series are shown in Table 2-1.

Table 2-1. Models description

Voltage level	Models		Rated capacity (KVA)	Rated output current	Applicable motor(KW) Applicable
220V Single phase	DGI300-2S0004G		1.1	3.0	0.4
	DGI300-2S0007G		1.5	4.7	0.75
	DGI300-2S0015G		2.8	7.5	1.5
	DGI300-2S0022G		3.8	10.0	2.2
220V Three	DGI300-2T0015G		3.0	7.0	1.5
	DGI300-2T0022G		4.0	10.0	2.2
380V Three phase	DGI300-4T0007G	DGI300-4T0015P	1.5	2.5	0.75
	DGI300-4T0015G	DGI300-4T0022P	2.5	4.0	1.5
	DGI300-4T0022G	DGI300-4T0037P	3.0	6.0	2.2
	DGI300-4T0037G	DGI300-4T0055P	5.9	9.6	3.7
	DGI300-4T0055G	DGI300-4T0075P	8.5	14.0	5.5
	DGI300-4T0075G	DGI300-4T0110P	11	17.0	7.5
	DGI300-4T0110G	DGI300-4T0150P	17	25	11
	DGI300-4T0150G	DGI300-4T0185P	21.7	32	15
	DGI300-4T0185G	DGI300-4T0220P	25.7	39	18.5
	DGI300-4T0220G	DGI300-4T0300P	29.6	45	22
	DGI300-4T0300G	DGI300-4T0370P	39.5	60	30
	DGI300-4T0370G	DGI300-4T0450P	49.4	75	37
DGI300-4T0450G	DGI300-4T0550P	60	91	45	

380V Three	DGI300-4T0550G	DGI300-4T0750P	73.7	112	55
	DGI300-4T0750G	DGI300-4T0900P	99	150	75
	DGI300-4T0900G	DGI300-4T1100P	116	176	90
	DGI300-4T1100G	DGI300-4T1320P	138	210	110
	DGI300-4T1320G	DGI300-4T1600P	167	253	132
	DGI300-4T1600G	DGI300-4T1850P	200	304	160
	DGI300-4T1850G	DGI300-4T2000P	234	355	187
	DGI300-4T2000G	DGI300-4T2200P	248	377	200
	DGI300-4T2200G	DGI300-4T2500P	280	426	220
	DGI300-4T2500G	DGI300-4T2800P	318	474	250
	DGI300-4T2800G	DGI300-4T3150P	342	520	280
	DGI300-4T3150G	DGI300-4T3500P	390	600	315
	DGI300-4T3500G	DGI300-4T4000P	435	660	350
	DGI300-4T4000G	DGI300-4T4500P	493	750	400
	DGI300-4T4500G	DGI300-4T6300P	560	850	450

2.2 Specifications

Items		Specifications
Input	Rated Voltage	Single phase 220V, three phase 200V, three phase 380V; 50Hz/60Hz
	Range	Voltage: $\pm 20\%$ voltage unbalance rate: $< 3\%$; frequency: $\pm 5\%$
	Built-in filter	
Output	Rated voltage	0~200V/220V/380V
	Frequency range	0Hz~500Hz
	Frequency resolution	0.01Hz

	Overload ability	150% rated current for 1 minute, 180% rated current for 3 seconds
Control function	Modulation modes	Optimized space voltage vector SVPWM modulation
	Control mode	Sensorless vector control (with optimal low frequency compensation)
	Frequency precision	Digital setting: The highest frequency $\pm 0.01\%$ Analog setting: The highest frequency $\pm 0.2\%$
	Frequency resolution	Digital setting: 0.01Hz; Analog setting: The highest frequency $\times 0.1\%$
	Start frequency	0.40Hz ~ 20.00Hz
	Torque boost	Auto torque boost, manual torque boost 0.1%~30.0%
	V/F curve	Five ways: constant torque V/F curve, 1 kind of user defined V/F curve, 3 kinds of down torque curve (2.0/1.7/1.2 times the power)
	Acc./Dec. curve	Two ways: linear Acc./Dec., S-curve Acc./Dec.; 7 kinds of Acc./Dec. time, Time unit (minute/second) optional, max. time: 6000 mins.
	DC braking	DC braking start frequency: 0 ~ 15.00Hz braking time: 0 ~ 60.0s braking current: 0 ~ 80%
	Energy consuming braking	Below 22KW drive built-in energy consuming braking unit, external braking resistor is optional.
	Jog running	Jog frequency range: 0.1Hz ~ 50.00Hz, JOG Acc./Dec. time: 0.1 ~ 60.0s
	PI built-in	Easily constitute a close loop control system
	Multi-stage speed running	Multi-stage speed running available through built-in PLC or control terminals
	Textile swing frequency	Swing frequency available with preset and centre frequency adjustable
	Auto voltage regulation	Keep a stable voltage automatically when the grid voltage transients

	Auto energy saving running	Saving energy by auto optimizing V/F curve according to the load
	Auto current limiting	Auto current limiting to prevent frequent over current fault trip
	Fixed-length control	Inverter stops when reaches the preset length
	Communication	RS485 standard communication port available, support MODBUS communication protocol of ASCII and RTU, master-slave multi-machine interaction function available
Running function	Running command channel	Control panel : control terminal :serial port :3 channels switchable
	Frequency setting channel	Control panel potentiometer setting: ▲、▼control panel keys setting; Function code setting: Serial port setting; Terminal up/down setting: Input Analog voltage setting: Input Analog current setting: Input pulse setting; Combination ways setting; Above ways are switchable.
	Switch input channel	FWD/REV command: 8channels programmable switch inputs, 35kinds of function can be set separately
	Analog input channel	4~20mA: 0-10V: 2 optional analog inputs
	Analog output channel	4~20mA or 0~10V optional, setting frequency and output frequency ,etc feature output
	Switch/pulse output channel	Programmable open collector output: relay output :0~20KHz pulse output:
Control panel	LED digital display	Display setting frequency, output voltage, output current, etc.
	External meter display	Display output frequency, output current, output voltage, etc.
	Key lock	All the keys can be locked

	Parameter copy	Function code parameters are able to be copied between inverters when use remote control panel.
Protection function		Overcurrent protection: overvoltage protection: undervoltage protection: overheating protection: overload protection, etc.
Optional parts		Braking unit: remote control panel: cable: panel mounting feet, etc.
Environment	Environment	Indoors, free from direct sunlight, dust, corrosive gas, oil mist, steam, water dropper salt, etc
	Altitude	Lower than 1000m (derating is necessary above 1000m)
	Ambient temperature	-10°C ~ +40°C
	Humidity	<90%RH, no condensation
	Vibration	Lower than 5.9m/s (0.6g)
	Storage temperature	-20°C ~ +60°C
Structure	Protection level	IP20 (In the selection of state display unit or the keyboard state)
	Cooling	Forced air cooling
Installation		Wall mounted; Floor mounted

2.3 Parts of Inverter

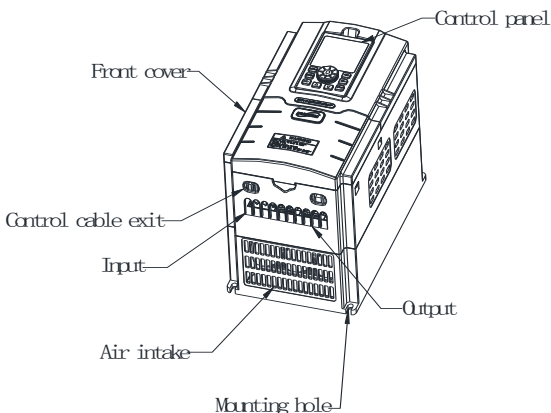

2.4 Dimensions

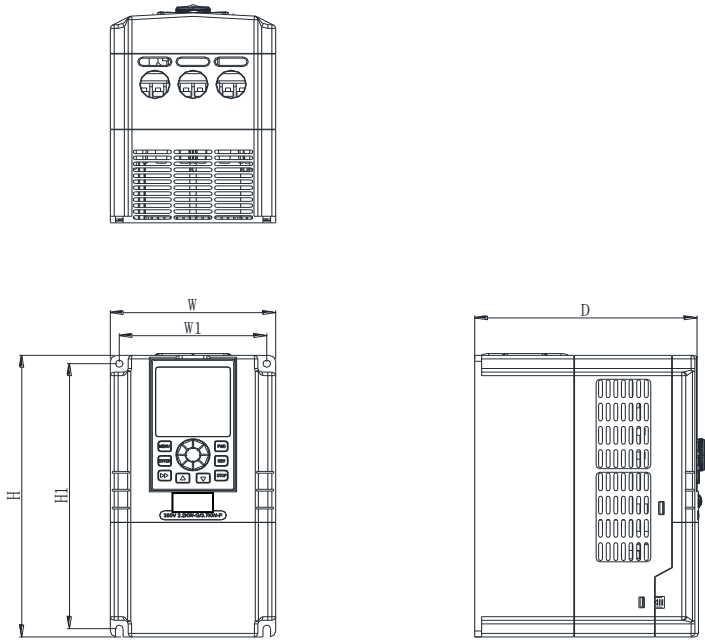

(a) 、 Inverters below 7.5KW

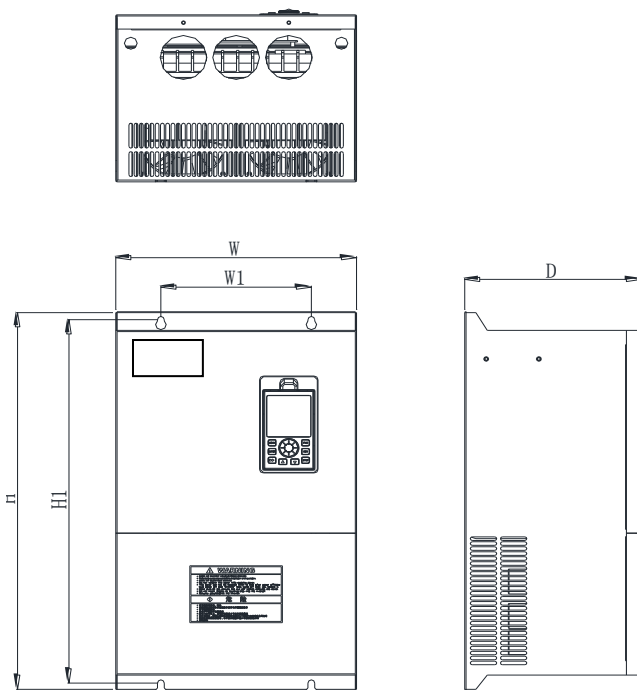

(b) 、 Inverters from 11KW to 90 KW

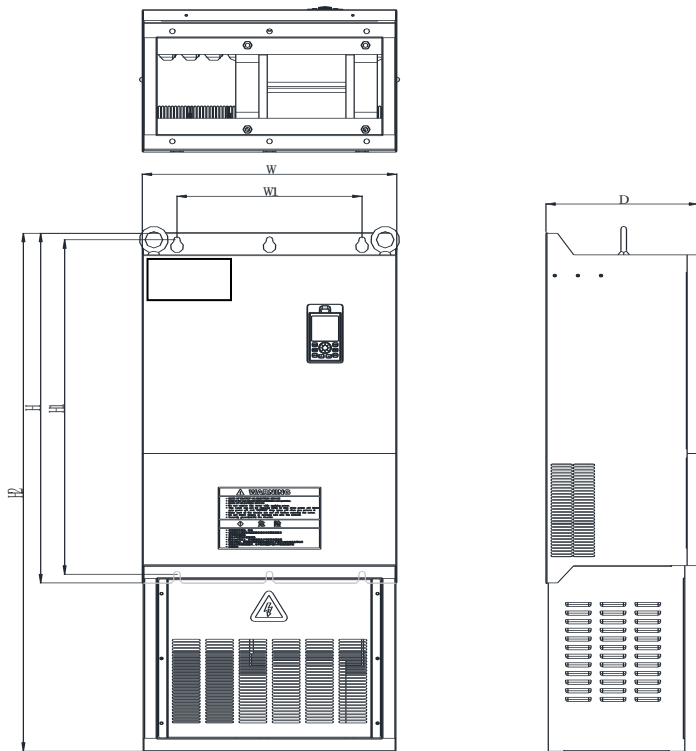

(c) 、 Inverters from 110KW to 250 KW

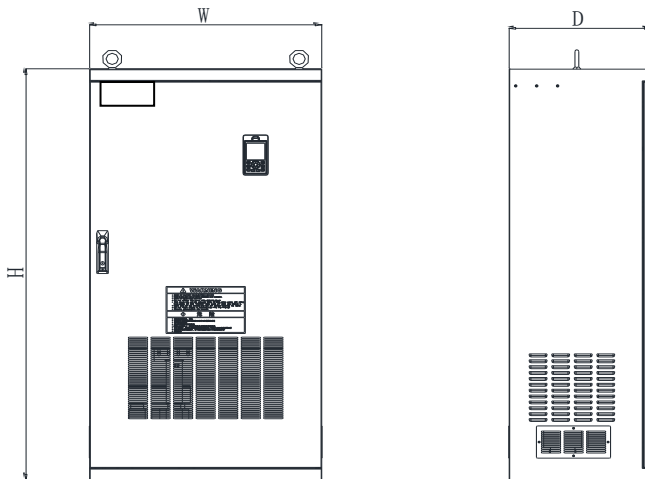
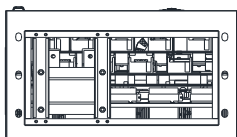

(d) 、 Inverters from 285KW to 315KW

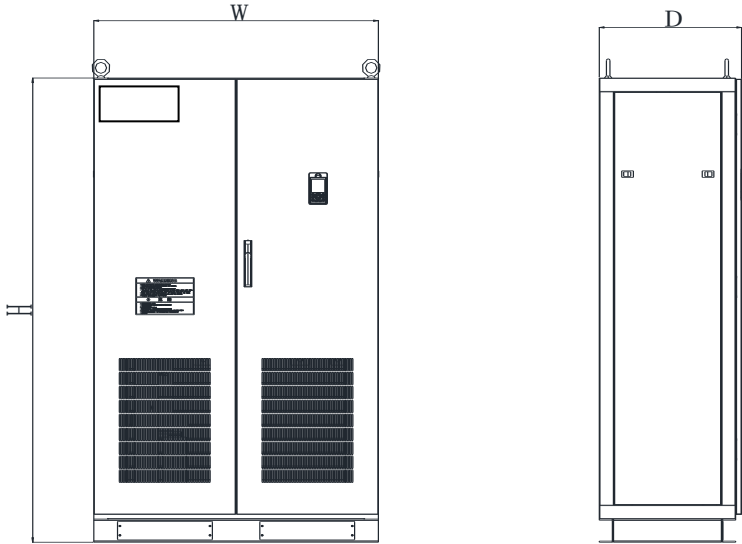
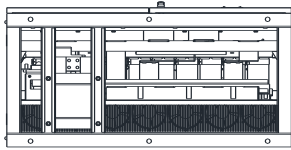

(e) 、 Inverters from 350KW to 630KW

Model		W1	W	H1	H	H2	D	Pore
G	P	(mm)	(mm)	(mm)	(mm)	(mm)	(mm)	Size
DGI300-2S0004G		74	85	144	142	N/A	113	Φ5
DGI300-2S0007G								
DGI300-2S0015G								
DGI300-4T0007G	DGI300-4T0015P	88	98	174	184	N/A	135	Φ5
DGI300-4T0015G	DGI300-4T0022P							
DGI300-4T0007G- Double display	DGI300-4T0015P- Double display	90	104	177	190	N/A	148	Φ5
DGI300-4T0015G- Double display	DGI300-4T0022P- Double display							
DGI300-4T0022G	DGI300-4T0037P	108	118	220	230	N/A	153	Φ5
DGI300-4T0037G	DGI300-4T0055P							
DGI300-4T0022G- Double display	DGI300-4T0037P- Double display	116	130	223	236	N/A	175	Φ5
DGI300-4T0037G- Double display	DGI300-4T0055P- Double display							
DGI300-4T0055G	DGI300-4T0075P	155	172	256	271	N/A	183	Φ5
DGI300-4T0075G	DGI300-4T0110P							
DGI300-4T0110G	DGI300-4T0150P	170	248	347	360	N/A	210	Φ6
DGI300-4T0150G	DGI300-4T0185P							
DGI300-4T0185G	DGI300-4T0220P	200	280	427	445	N/A	200	Φ8
DGI300-4T0220G	DGI300-4T0300P							
DGI300-4T0300G	DGI300-4T0370P	200	320	512	530	N/A	235	Φ8
DGI300-4T0370G	DGI300-4T0450P							
DGI300-4T0450G	DGI300-4T0550P	250	310	530	555	N/A	260	Φ10
DGI300-4T0550G	DGI300-4T0750P							

		W1	W	H1	H	H2	D	Pore
G	P	(mm)	(mm)	(mm)	(mm)	(mm)	(mm)	Size
DGI300-4T0750	DGI300-4T0900P	280	400	620	650	N/A	300	Φ14
DGI300-4T0900	DGI300-4T1100P							
DGI300-4T1100G	DGI3000-4T1320P	280	450	756	790	108 0	300	Φ14
DGI300-4T1320	DGI300-4T1600P							
DGI300-4T1600	DGI300-4T1850P							
DGI300-4T1850	DGI300-4T2000P	400	550	776	810	1150	330	Φ14
DGI300-4T2000	DGI300-4T2200P							
DGI300-4T2200	DGI300-4T2500P	480	640	776	810	127 0	330	Φ14
DGI300-4T2500	DGI300-4T2850P							

Model		W(mm)	H(mm)	D(mm)
G	P			
DGI300-4T2800G	DGI300-4T3150P	720	1400	440
DGI300-4T3150G	DGI300-4T3500P			
DGI300-4T3500G	DGI300-4T4000P	950	1700	475
DGI300-4T4000G	DGI300-4T4000P			
DGI300-4T5600G	DGI300-4T6300P	1200	2000	600
DGI300-4T6300G	DGI300-4T7100P			

Table 2-2 Dimensions (mm)

2.5 Optional Parts:

The following parts are optional. If require, please order

2.5.1 Remote control panel

RS485 communications applied between remote control panel and inverter which are connected by a 4-core cable via RJ45 network port.

The maximum connection distance is 500M. The inverter supports local control panel and remote control panel used at the same time, no priority. Both can control the inverter. Hot plug in for remote control panel is available.

The following functions are available by using remote control panel:

- (1) Control slave inverter to run, stop, jog run, fault reset, change setting frequency, change function parameters and running direction.
- (2) Monitor slave inverter's running frequency, setting frequency , output voltage, output current, bus bar voltage, etc.

2.5.2 Communication cable for remote control panel

Type: DGI300-LAN0020 (2.0m)

Standard options:1m, 2m, 5m, 10m, 20m. Which is more than 20m can be customized for the remote keyboard and inverter connection.

2.5.3 Field bus Adaptor

The inverter can be connected into MODBUS field bus net work via adaptor as a slave station in the network.

The function as follow:

- (1) send command to inverter such as start, stop, jog running, etc.
- (2) Send speed or frequency signal to inverter.
- (3) Read status from inverter.
- (4) Fault reset for the inverter.

Please refer to Chapter 9 for communication protocol

2.5.4 Braking Resistors

DGI300 series inverters under 22KW have built-in braking units. If energy consuming braking is needed, please choose braking resistors according to Table 2-3. The wire connections of

braking resistors are shown in Fig. 2-2.

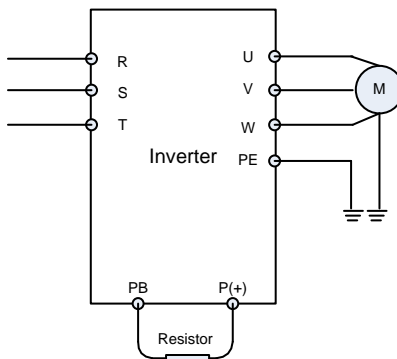

Fig.2-2 The wire connection of braking resistors

Table 2-3 Braking resistors selection table

Model	Applicable motor (KW)	Resistance(Ω)	Resistance power
DGI300-2S0004G	0.4	200	100W
DGI300-2S0007G	0.75	150	200W
DGI300-2S0015G	1.5	100	400W
DGI300-2S0022G	2.2	75	500W
DGI300-4T0007G	0.75	300	400W
DGI300-4T0015G	1.5	300	400W
DGI300-4T0022G	2.2	200	500W
DGI300-4T0037G	4.0	200	500W
DGI300-4T0055G	5.5	100	800W
DGI300-4T0075G	7.5	75	800W
DGI300-4T0110G	11	50	1KW
DGI300-4T0150G	15	40	1.5KW
DGI300-4T0185G	18.5	30	4KW
DGI300-4T0220G	22	30	4KW
DGI300-4T0300G	30	20	6KW

DGI300 - Degdrive

DGI300-4T0370G	37	16	9KW
DGI300-4T0450G	45	13.6	9KW
DGI300-4T0550G	55	20×2	12KW
DGI300-4T0750G	75	13.6×2	18KW
DGI300-4T0900G	90	20×3	18KW
DGI300-4T1100G	110	20×3	18KW
DGI300-4T1320G	132	20×4	24KW
DGI300-4T1600G	160	13.6×4	36KW
DGI300-4T1850G	185	13.6×4	36KW
DGI300-4T2000G	200	13.6×5	45KW
DGI300-4T2200G	220	13.6×5	45KW
DGI300-4T2500G	250	13.6×5	45KW
DGI300-4T2800G	280	13.6×6	54KW
DGI300-4T3150G	315	13.6×6	54KW
DGI300-4T3500G	350	13.6×7	63KW
DGI300-4T4000G	400	13.6×8	72KW
DGI300-4T4500G	450	13.6×8	90KW

Chapter 3 Installation and Wire Connection

3.1 Installation

3.1.1 Environment Requirements

- (1) Please mount inside a well-ventilated location. The ambient temperature is required to be within the range of -10 ~40°C. If the temperature is higher than 40 °C, the inverter should be de-rated, at the same time the ventilation and heat dissipation should be enhanced.
- (2) Be away from the location full of dust or metal powder, and mount in the location free of direct sunlight.
- (3) Mount in the location free of corrosive gas or combustible gas.
- (4) Humidity should be lower than 90% with no dew condensation.
- (5) Mount in the location where vibration is less than 5.9m/s^2 (0.6G) .
- (6) Please try to keep the inverter away from EMI source and other electronic devices which are sensitive to EMI.

3.1.2 Mounting Space and Direction

- (1) Generally in vertical way.
- (2) For the requirements on mounting space and distance, refer to Fig.3-1.
- (3) When several inverters are installed in one cabinet, they should be mounted in parallel with special incoming and out coming ventilation and special fans. When two inverters are mounted up and down, an air flow diverting plate should be fixed as shown in Fig.3-2 to ensure good heat dissipation.

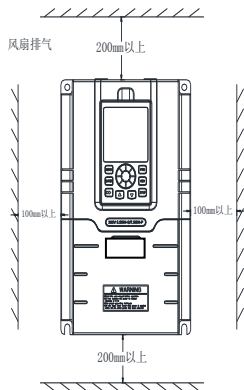

Fig.3-1 Mounting space and distance

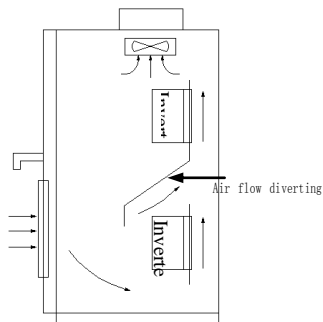

Fig.3-2 Mounting of multiple inverters

3.2 Removing and Mounting Front Cover of Inverter

Removing: remove 4screws on the cover and take the cover out.

Mounting: Align the mounting holes and screw them.

3.3 Wire Connection

Attention



- (1) Before wiring, please ensure the power has been removed and be waited for at least 10minutes.
- (2) Please do not connect AC power to output terminals U/V/W.
- (3) To ensure the safety, the inverter and motor should be safety grounding. It is necessary to use copper wire above 3.5mmas ground wire, grounding resistance less than 10Ω.
- (4) The inverter has gone through voltage withstand test in factory, please do not make it again.

- (5) Solenoid switch or absorbing devices, such as ICEL, is prohibited to connect inverter output.
- (6) To provide input over current protection and for convenience in maintenance, the inverter should be connected to AC power through circuit breaker.
- (7) Please use twisted wire or shielded wire above 0.75mm for the wiring of relay input/output loop(X1~X6, FWD, REV, OC, DO).One end of shielding layer suspended, and the other side connected to PE grounding terminal of inverter, wiring length less than 50m .

Danger



- (1) The cover can be removed only when the power is switched off, all the LEDs on the panel are off and waiting at least for 10 minutes.
- (2) Wiring work can be performed only when the DC voltage between P+ and P- terminals is lower than 36V.
- (3) Wiring work can only be done by trained or professional personnel.
- (4) Before usage, check whether the mains voltage meets the requirement of inverter input voltage.

3.4 Main Circuit Wiring

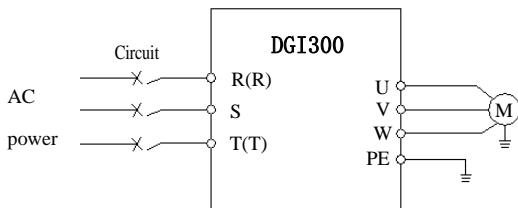



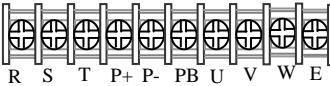



Fig. 3-3 Main circuit wiring

3.4.1 Main Circuit Wiring

Main Circuit input/output terminals, shown as Table 3-1|

Table 3-1 Description of Main Circuit input/output terminals

Apply to	Main circuit terminal	Terminal name	Function
220V 1-phase 0.4KW~2.2KW	 L1 L2 E U V W	L1、L2	220V 1-phase Input terminals
		U、V、W	380V 3-phase Output terminals
		E	Earthing
380V 3-phase 0.75KW~2.2KW	 R S T PB P+ U V W	R、S、T	380V 3-phase Input terminals
		U、V、W	380V 3-phase Output terminals
		P+、PB	Braking resistor wiring terminals
380V 3-phase 2.2KW~5.5KW	 P+ PB R S T U V W E	R、S、T	380V 3-phase Input terminals
		U、V、W	380V 3-phase Output terminals
		P+、PB	Braking resistor wiring terminals
380V 3-phase 7.5KW~15KW	 R S T P+ P- PB U V W E	R、S、T	380V 3-phase Input terminals
		U、V、W	380V 3-phase Output terminals
		P+、PB	Braking resistor wiring terminals
380V 3-phase 18.5KW~280KW	 R S T P+ P- U V W E	R、S、T	380V 3-phase Input terminals
		U、V、W	380V 3-phase Output terminals
		P+、P-	Braking resistor wiring terminals

3.5 Basic Wiring Diagram

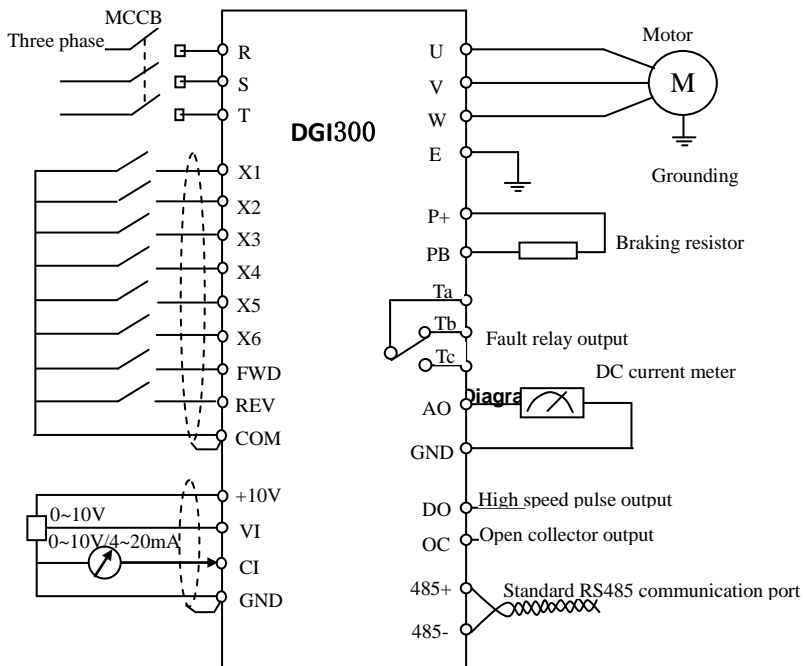

3.6 Control Circuit Terminal Wiring

3.6.1 Position and Function of Terminals and Jumpers on Control Circuit

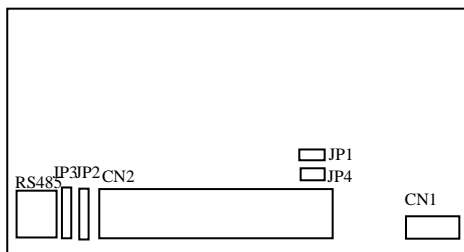

Fig. 3-6 Position of terminals and jumpers on control

using the inverter, Please make correct terminals wiring and jumpers setting. It is suggested to use above 1mm² wire as terminal connection wire.

Table 3-2 Jumper switch function

NO	Function Setting	Setting	FD
JP1	Pulse output terminal DO power selection	1-2 connected: internal 24V power of inverter 2-3 connected: external power	external power
JP2	Analog output terminal current/voltage output selection	1-2: 0~10V: AO1 output voltage signal 2-3: 4~20mA: AO1 output current signal	0~10V
JP3	Terminal CI current/voltage Input selection	1-2 : V side, 0~10 V voltage signal 2-3 : I side, 4~20 mA current signal	0~10V
JP4	X7 terminal input mode selection	1-2 : PLC side, X7 used as multifunctional terminal 2-3 : FCH side: X7 used as an external pulse input	PLC side

3.6.2 Description of Terminals on Control Circuit

(1) Function of CN 1 terminal shown as Table 3-3

Table 3-3 CN 1 terminal function

Sort	Terminal	Name	Function Description	Specification
Relay output terminal	TA/RA	Multi functional relay output terminal	Can be defined as	TA-TC: NC, TA-TB: Normally open contact capacity AC250V/2A (COSΦ=1) AC250V/1A (COSΦ=0.4) DC30V/1A
	TB/RB		multifunctional	
	TC/RC		Relay output terminal by programming, refer to Chapter 6.5 P4.12, P4.13	

(2) Control Circuit CN2 terminal shown as Fig.3-7

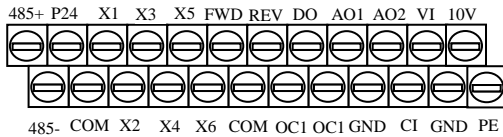

Fig.3-7 CN2 terminal order

(3) Function of CN 2 terminal shown as Table 3-4

Table 3-4 CN 2 terminal function

Sort	Terminal	Name	Function Description	Specification
Communication	485+	RS485 communication port	RS485 differential signal positive terminal	Twisted or shielded wire needed
	485-		RS485 differential signal negative terminal	

Multifunctional output terminal	OC1	Open collector output terminal 1	Can be defined as multifunctional on-off output terminal by programming, refer to Chapter 6.5P4.10 (Common port: COM)	Couple isolated output Working voltage: 9~30V Max.outputcurrent:50mA
	OC2	Open collector output terminal 1	Can be defined as multifunctional on-off output terminal by programming, refer to Chapter 6.5P4.11 (Common port: COM)	Couple isolated output Working voltage: 9~30V Max.outputcurrent:50mA
Pulse output terminal	DO	Open collector pulse Output terminal	Can be defined as multifunctional Pulse output terminal by programming, Refer to Chapter 6.5P4.21/P4.22 (Common port: COM)	Max. output frequency: 20KHz output freq range defined by P4.21
Analog input	VI	Analog input VI	Analog voltage input (Grounding: GND)	Input voltage range:0~10V (input resistance:10KΩ) Resolution: 1/1000
	CI	Analog input CI	Analog voltage/current input, Choose voltage or current input by Setting JP3 jumper. Factory default: voltage input (Grounding: GND)	Inputvoltage range:0~10V (input resistance:10KΩ) Inputcurrentrange:0~20mA (input resistance:500Ω) Resolution: 1/1000

Analog output	AO1	Analog output AO1	Analog voltage/current output, indicating 7 quantities, choose Voltage or current output by setting JP2 jumper. Factory default: voltage output (Grounding: GND)	Current output range: 4~20mA Voltage output range: 0~10V
	AO2	Analog output AO2	Analog voltage output, indicating 7 quantities (Grounding: GND)	Voltage output range: 0~10V
Runnin g	FWD	Forward	Refer to chapter 6.5 P4.08	Couple isolated input Input resistance: 2KΩ Max. input frequency: 200Hz Input voltage range: 9~30V
	REV	Reverse		
Multifunctional input terminal	X1	Multifunctional input terminal 1	Can be defined a smultifunctional on-off input terminal by programming, Referring to Chapter 6.5 P4. (Common port: COM)	
	X2	Multifunctional input terminal 2		
	X3	Multifunctional input terminal 3		
	X4	Multifunctional input terminal 4		
	X5	Multifunctional input terminal 5		
	X6	Multifunctional input terminal 6		
Power source	P24	+24V power source	Supply +24V power (negative terminal: COM)	
	10V	+10V power source	Supply +10V power (negative terminal: GND)	Max. output current: 50mA

	GND	+10Vcommon port	Grounding of analog signal and+10V power source	Terminal COM and GND are isolated inside
	COM	+24Vcommon port	Digital signal input, output common port	

3.6.3 Analog Input/Output Terminal Wiring

(1) Analog voltage signal input through VI terminal as follow wiring:

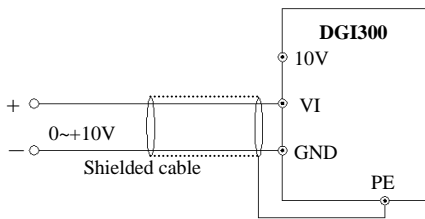

Fig. 3-7 VI terminal wiring

(2) Analog signal input through CI terminal, jumper selection for input voltage (0~10V) or input current (4~20mA) as follow wiring

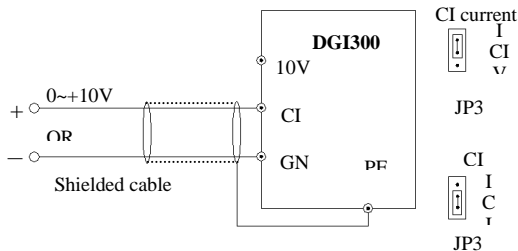

Fig. 3-8 CI terminal wiring

(3) Analog output terminal AO wiring

Analog output terminal can be connected with external analog meter indicating various physical quantity, jumper selection for output voltage (0~10V) or output current (4~20mA) as follow wiring.

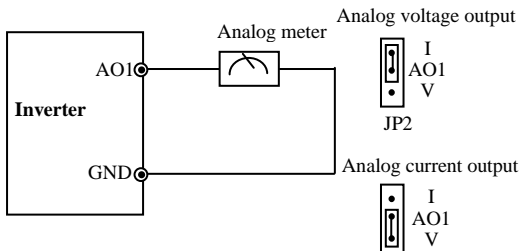

Fig. 3-9 Analog output terminal wiring

Notes:

- (1) Filter capacitor or common-mode inductor can be installed between VI And GND terminal or CI and GND terminal when using analog input mode.
- (2) Please use shielded cable and do well grounding , keep the wire as short as possible in order to prevent external interference when using analog input/o output mode.

3.6.4 Communication Terminal Wiring

The inverter supplies standard RS 485 communication port

It can constitute one master one slave control system or a one master multi slaves system. The upper computer(PC/PLC)can real time monitor the inverter in the control system and achieve complicated control function such as remote control and spermatic, etc

- (1) Remote control panel can be connected with inverter viaRS485port by plugging in the remote control panel into RS485 port without any parameter setting. The local control panel of inverter and remote control panel can work at the same time.

(2) Inverter RS 485 port and upper computer wiring as follow:

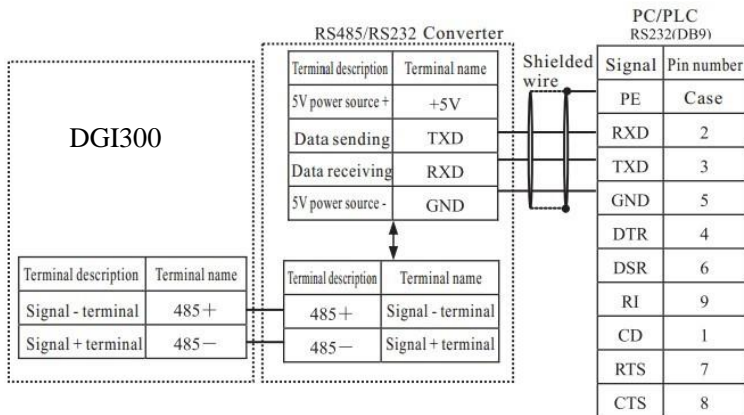

Fig. 3-10 RS485-(RS485/232)-RS232 communication wiring

(3) Multi inverters can communicate via RS485, controlled by PC/PLC as a Master shown as Fig.3-12. It also can be controlled by one of inverters as a Master shown as Fig.3-13

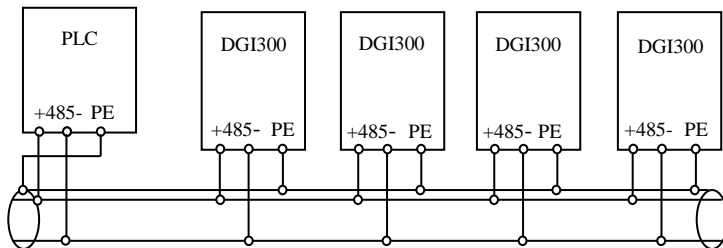

Fig. 3-12 PLC communication with multi inverters

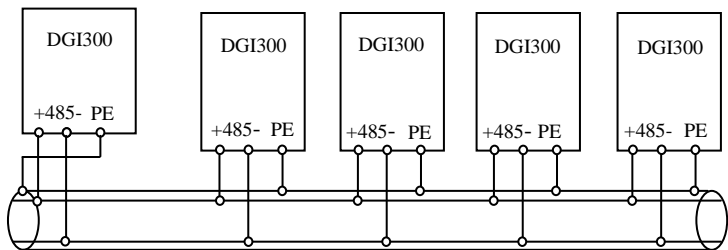

Fig. 3-13 Multi inverters communication

The more inverters connected, the more the communication interference may occur. Please make wiring as above and do well grounding for inverters and motors, or adopt the following measures to prevent interference as even above wiring can't work.

- (1) Separately power supply to PC/PLC or isolated the power of PC/PLC.
- (2) Use EMIFIL to the wire or reduce carrier frequency properly

3.7 EMC Installation Instruction

Inverter outputs PWM wave, it will produce electromagnetic noise. To reduce the interference, EMC installation will be introduced in this section from noise suppression, wire connection, grounding, leakage current and filter of power supply

3.7.1 Noise Suppression

(1) Noise Type

Noise is unavoidable during inverter operation. Its influence over peripheral equipment is related to the noise type, transmission means, as well as the design, install action, wiring and grounding of the driving system

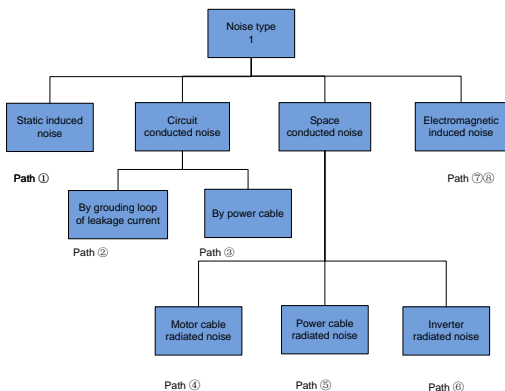

(2) Noise Suppression Methods

Path	Noise suppression methods
②	If a closed loop is formed between the peripheral equipment and the inverter wiring, the grounding leakage of the inverter will misoperate the equipment. Solution: Remove the grounding of the peripheral equipment.
③	When peripheral equipment share the same power source with the inverter, the noise transmitted through the power line may misoperate the peripheral equipment. Solution: Mount a noise filter at inverter input side or isolate the peripheral equipment with an isolated transformer or power filter.
④⑤⑥	Electronic equipment such as computers, measuring meters, sensors and radio equipment, when in the same cabinet with inverter, with their wiring close to the inverter, may misoperate due to radio interference. Solution: (1) The susceptible equipment and its signal lines should be kept away from the inverter. Use shielded cable for the signal line. Ground the shielding coat. Protect the signal cable with a metal pipe and keep it off the inverter input/output cable. When crossing of the signal line and the inverter input/output cables is inevitable, make sure it is orthogonal. (2) Mount radio noise filter or linear noise filter (choke coil) to the input/output side of the inverter to suppress the radio noise.

	<p>(3) The shielding coat for the cable connecting inverter and the motor should be thick. The wiring can be arranged through thick pipe (2mm or thicker) or cement trench. The cable should be through a metal pipe, and has its shielding coat grounded. You may use the 4-core cable as the motor power cable. Ground one core at inverter side with the other end of it connected to the motor case.</p>
<p>①⑦⑧</p>	<p>When the signal cables are parallel to, or bound together with the power cables, the static and electromagnetic induction will cause the noise transmit through the signal cable, misoperating the related equipment.</p> <p>Solution:(1) Avoid laying the signal cables parallel to the power cable, or bind them together. (2) Keep the susceptible peripheral equipment away from the inverter. (3) Keep the susceptible signal cables away from the input/output cables of inverter. Shielded cables should be used as the signal or power cable. Lead them through metal pipes respectively would achieve better effect. The metal pipes should be at least 20cm away from each other.</p>

Table2-5 Noise suppression method

3.7.2 Wiring Connection and Grounding

(1) Please do not to wire motor cable (from inverter to motor) in parallel with power cable and keep at least 30cm from each other .

(2) Please try to arrange the motor cable through Control signal cable metal pipe or in metal wiring groove.

(3) Please use shielded cables control signal cable, and connect the shielding coat to PE terminal of inverter with proximal grounding to inverter.

(4) PE grounding cable should be directly connected to the earth plate.

(5) The control signal cable shouldn't be in parallel with strong electricity cable(power cable/motor cable).They should not be bent together and should be kept away as least 20cm from each other. If cable crossing is inevitable, please make sure it is same as Fig.3-1 6

(6) Please ground the control signal cable separately with power cable/motor cable.

(7) Please don't connect other devices to inverter power input terminals(R/S/T) .

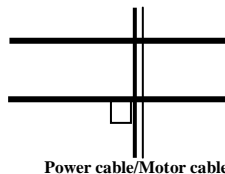

Fig. 3-16 Orthogonal wiring



Chapter 4 Running of Inverter

4.1 Running of Inverter

4.1.1 Running Command Channels

There are three channels for inverter receiving commands like START, STOP, JOG and others.

Control panel

Use    Keys on the panel to control the inverter.(Factory default)

Control terminal

Use terminal FWD,REV, COM to constitute a 2-wire control mode, or use one of terminals amongX1~X6 and FWD, REV to constitute a 3-wire control mode.

Serial port

Use upper computer (PC/PLC) or Master inverter to control Slave inverter to start or stop via serial port.

The command channels can be selected by setting Function Code P0.03, or by multifunctional input terminal (function code P4.00-P4.07).

Note: These three channels are all switchable. Please make debugging before switch so as to avoid equipment damage and personal injury.

4.1.2 Frequency setting channel

There are 8 kinds of frequency setting channels as follow:

0: by control panel potentiometer

1: by   control panel keys

2: digital setting by function code via control panel

3: via terminal UP/DOWN

4: by upper computer via serial port

5: analog setting via VI terminal

6: analog setting via CI terminal

7: via pulse terminal

8: combination setting

4.1.3 Inverter Running States

When inverter power on, there are two states which are Standby and running state.

Standby state: When power switch on, inverter will be in standby state before receiving control command. Or receiving Stop command during inverter running, inverter will stop and standby.

Running state: After running control command is received, the inverter enters running state

4.1.4 The Running Modes of Inverter

There are five running modes according to priority which are JOG running, close loop running, PLC running, multi-stage speed running, and normal running as shown in Fig.4-1.

0: JOG running

In stopping state, after receiving JOG running command, the inverter will run according to JOG frequency, for example, by pressing control panel  key to give JOG command (refer to function code P3.06~P3.08).

1: Close loop running

By setting close loop running control parameter enabled (P7.00=1), the inverter will enter close loop running, that is PI regulation (refer to function code P7). To make close loop running invalid, please set multifunctional input terminal (function27) and switch to lower priority running mode.

2: PLC running

By setting PLC function parameter enabled (P8.00 ≠0), the inverter will enter PLC running mode and run according to preset running mode (refer to function code P8). To make PLC running invalid, please set multifunctional input terminal (function29) and switch to lower priority running mode.

3: Multi-stage speed running

By setting non-zero combination of multifunctional input terminal (function1,2,3) and selecting multi-frequency 1-7, the inverter will enter multi-stage speed running mode(refer to function codeP3.26~P3.32).

4: Normal running

Simple open loop running mode of inverter.

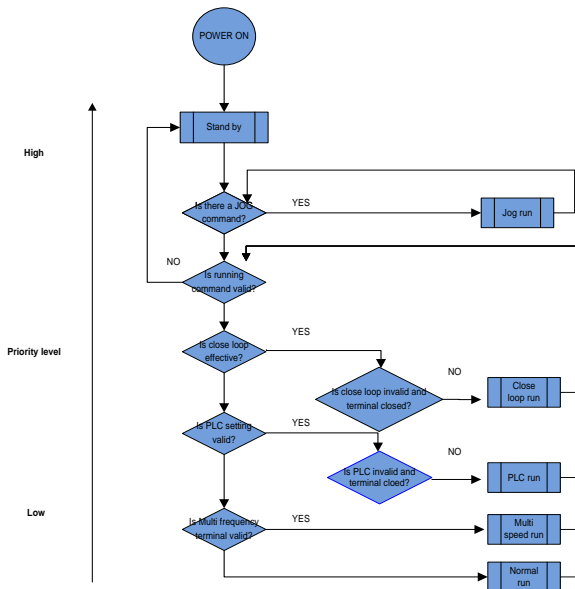

Fig.4-1 Running mode logic diagram

The above 5 kinds of running modes can be running in multiple frequency setting channel except JOG running. PLC running, multi-stage speed running and normal running can carry out swing frequency running

4.2 Operation and Using of the Control Panel

4.2.1 Control Panel Layout

User can control inverters' start, frequency adjust, stop, braking, setup the running parameters and control peripheral equipment through control panel and control terminal

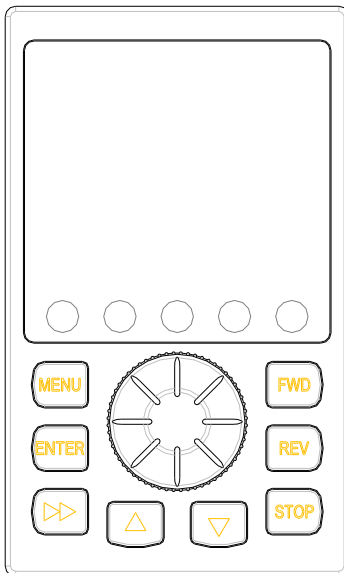











Fig. 4-2 Control panel diagram

4.2.2 Control Panel Function

There are 8 keys and 1 analog potentiometer on the inverter's panel.

The function are shown as follow:

Key	Name	Function Description
	Run	In keypad mode, pressing the key, inverter will run

	Multifunction	REV key is defined as Reverse function. It is also self-defined key which can be set by Parameter
	Stop/Reset	Inverter in running status, pressing the key will stop inverter when command given by keypad. In fault status, pressing the key can reset
	Function/Data	Enter or exit programming status
	UP	Data or function code increment
	DOWN	Data or function code decrement
	Shift/Monitor	In programming, the key can shift code digit. In other status, the key can shift monitoring parameter
	Reserve/switch	In programming, the key can enter next step manual or reserve the setting.
	Digital potentiometers	Left rotary, the same function as UP key. Right rotary, the same function as DOWN KEY Pressing potentiometer, the same function as 

4.2.3 LED Display and Indicator Description

There are a 4 digits LED display, 3 unit indicators and 3 state indicators. These 3 unit indicators have 6 kinds of combinations corresponding to 6 kinds of unit indicating as Fig.4-3

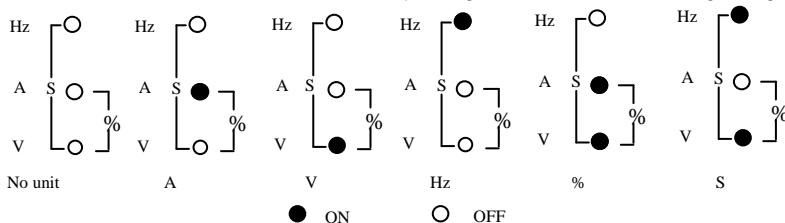

Fig. 4-3 Indicator state and unit indicating

Table 4-2 State indicator description



Item		Function Description	
Display function indicator	LED digital		Display inverter's running state parameters and setting parameters.
	State indicator	FWD	When the motor is running forward, this indicator is on.
		REV	When the motor is running reverse, this indicator is on.
	ALM	When there is a fault alarm, this indicator is on	
		When the inverter is in DC braking state, the FWD and REV indicator are on at the same time.	

4.2.4 Control Panel Display State

The control panel display state includes parameter displaying in stopping state, function code parameter displaying in programming state, fault displaying in alarm state, and parameter displaying in running state.

A. Parameter displaying in stopping state

When inverter is in stopping state, panel displays stopping state monitoring parameter which usually is setting frequency (b-01 monitoring parameter) shown as Fig.4-4 B.

Press  key to display the other monitoring parameter (The inverter default displays the first 7 monitoring parameters of b group. The other parameters can be defined by function code P3.41 and P3.42. Please refer to Chapter 5). Press  key for switching to default display parameter b-01, which is setting frequency, or it will display the last monitoring parameter.

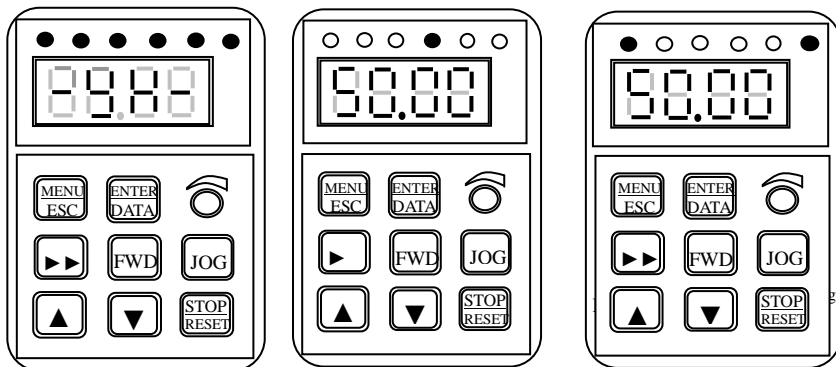





Fig.4-4 Parameter display in initialization, stopping and running state.**B、 Parameter displaying in running state**

The inverter enters running state after receiving valid running command, and the panel displays running state monitoring parameter. The default displaying is output frequency (b-00 monitoring parameter) shown as Fig.4-4 C.

Press  key can display the monitoring parameter in running state (defined by function code P3.41 and 3.42). While parameter displaying, press  key for switching to default display parameter b-00, that is output frequency, or it will display the last monitoring parameter.

C、 Fault displaying in alarm state

The Inverter enters fault alarm display state after fault signal detected. The displayed fault code will be flashing.

Press  key to check fault related parameter. When checking fault related parameter, press  key for switching to Fault code display.

Press  key to enter programming state to check P6 group parameter of fault information

After troubleshooting, press  key to reset the inverter (or via control terminal/serial port)

If the fault still exists, it will keep displaying the fault code.

Note:

To some serious fault such as IGBT protection, over current, over voltage, etc. Don't reset the inverter before clearing the fault for sure, otherwise there is a danger of damage.

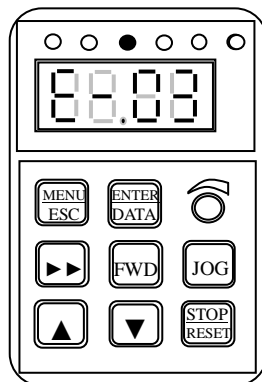
**Fig. 4-5 Fault alarm display state**

D、Function code programming state

In the state of stopping, running, and fault alarm, press **MENU/ESC** key to enter programming state (A password is required, If it has been set. Please refer to P0.00 description and Fig.4-10). The programming state includes three level display menus shown as Fig.4-6 which in order are function code group → function code number → function code parameter. Press **ENTER/RDAT** key to enter each menus. When in function code parameter display menu, press **ENTER/RDAT** key to save parameter, press **MENU/ESC** key to go back to previous menu without parameter saving.

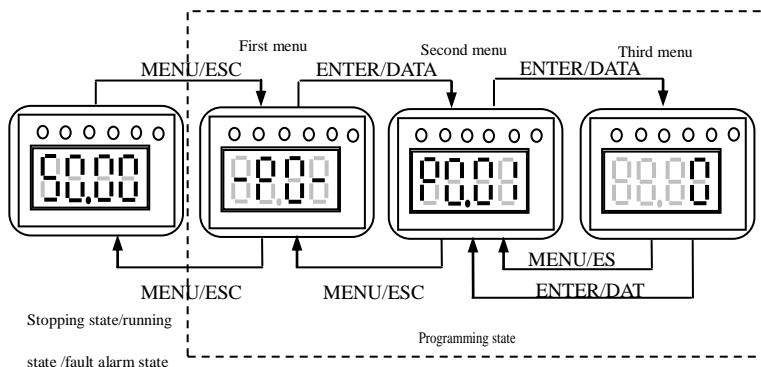

Fig. 4-6 Control panel programming state

4.2.5 Control Panel Operation

Through the operating panel of inverter for various operations, for example as follows:

A、Switching display of state monitoring parameter

Press **▶▶** key to display b group state monitoring parameter. It first displays the code of monitoring parameter, after 1 second, it switches automatically to display the value of this monitoring parameter shown as Fig.4-7.

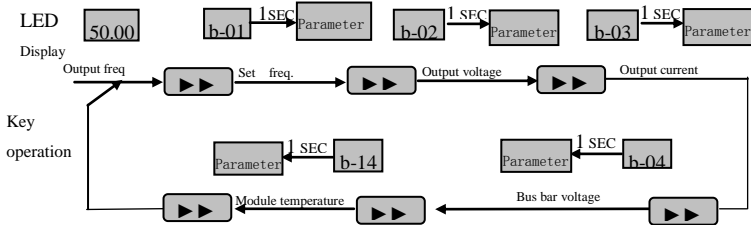

Fig. 4-7 Operation to display monitoring parameter

(2) When viewing monitoring parameter, press **ENTER DATA** key for switching to default monitoring parameter display state. Default monitoring parameter is setting frequency in stopping state. In running state, the default monitoring parameter is output frequency.

B、Function code parameter setting

For example, to set parameter code P3.06 from 5.00Hz to 8.50Hz.

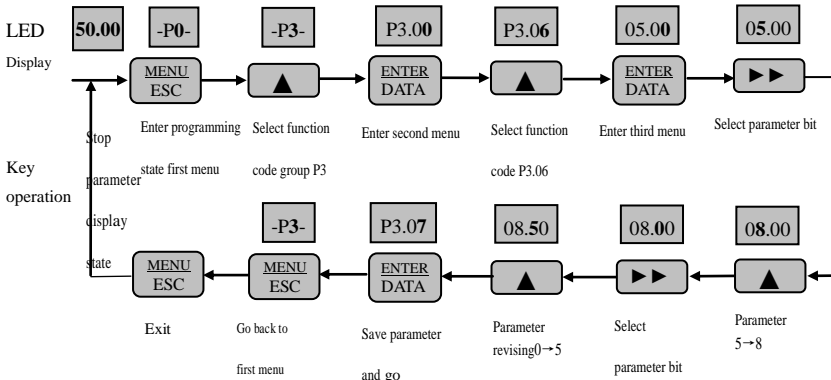

Fig. 4-8 Example of function code parameter setting

Note: In third level menu, if the parameter displayed is not in flashing, it means that this function code is unable to be revised. Probably the reasons are:

(1) This function code parameter is unmodifiable, such as actual detected state parameter,

record running parameter, etc.

(2) This function code parameter can not be revised in running state. It just can be revised in stopping state.

(3) The parameter is under protection. When function code P3.01 unit's place is 1 or 2, all function code parameter can not be revised. This is parameter protection to avoid fault operation. Set P3.01 unit's place as 0 to make modification available.

C、JOG running operation

Following is an example. Suppose it is in panel control mode and in stopping state, JOG running frequency is 5Hz.

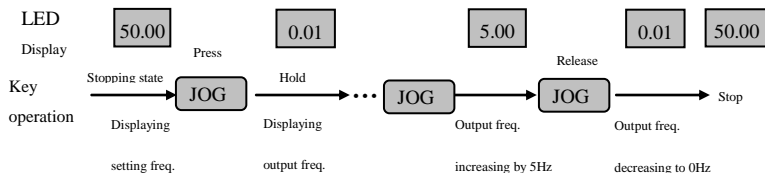

Fig.4-9 JOG running operation

D、Password authentication operation

Suppose P0.00 password parameter has been set as "2345". The authentication operation is shown as Fig. 4-10. The bold figure represents the flashing bit.

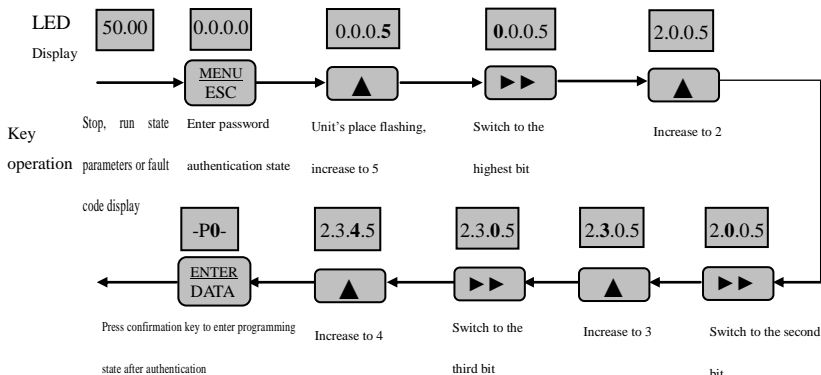

Fig. 4-10 Example of password authentication operation

E、Inquiring fault related parameter:

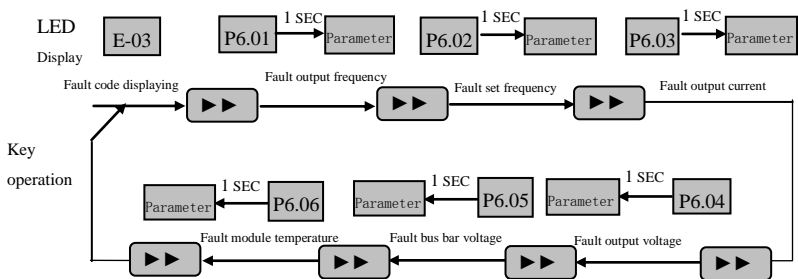

Fig. 4-11 Example of inquiring fault related parameter

Note:

- (1) In fault code display state, press key to inquire P6 group function code parameter. The range is from P6.01 to P6.06. After p key, LED first displays function code, and 1 second later it displays automatically the value of this function code parameter.
- (2) When inquiring fault parameter, press key to switch back to fault code display state.

F、Frequency setting operation by control panel , keys

Suppose it is in stopping state and P0.01=1, the operation is as follow.

- (1) Frequency integral adjustment.
- (2) As press key and hold it, LED begins to increase from unit's digit to ten's digit, and then to hundred's digit. If release key and then press key again, LED will increase from unit's digit again.
- (3) As press key and hold it, LED begins to decrease from unit's digit to ten's digit, and then to hundred's digit. If release key and then press key again, LED will decrease from unit's digit again.

G、Control panel key lock operation:

Press key for 5 seconds to lock control panel key. It displays 'LOCC',

as panel locked.

H、 Control panel key unlock operation:

Press  key for 5 seconds to unlock control panel key.

4.3 Inverter power switch on

4.3.1 Inspection Before Power on

Please perform cable connection according to the requirements in manual.

4.3.2 Initial Power on Operation

After inspecting cable connection and power source for sure, switch on inverter input AC power switch. The inverter's LED on control panel will display dynamic start menu. When it displays set frequency, it means initialization has been completed.:

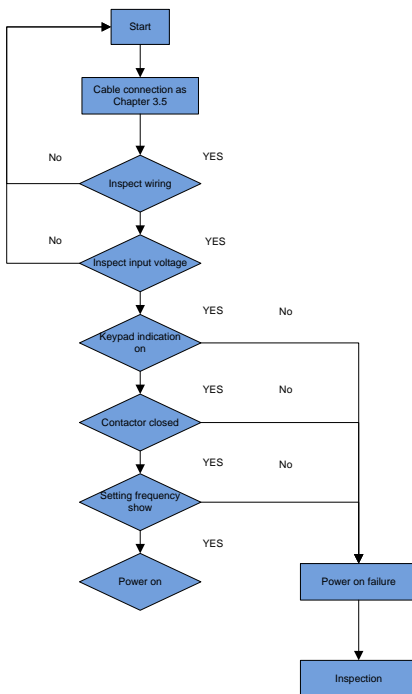

Fig. 4-12 Inverter first power applied operation

Chapter 5 Function Parameter Table

5.1 Symbol Description

“○”: means that the parameter can be modified during running state.

“×”: means that the parameter can not be modified during running state.

“*”: means read-only parameter which can not be modified.

5.2 Function Code Table

P0 Group: Basic running function parameter					
Func Code	Name	Range	Min Unit	Factory Default	Modify
P0.00	Control mode selection	0: V/F Control 1: Senseless vector control	1	0	○
P0.01	Freq control channel selection	0: Analog potentiometer on control panel(single display valid) 1: ▲、▼key on control panel(single display valid) Panel digital potentiometer+▲、▼key on control panel(double display valid) 2: Digital setting 1, control panel given 3: Digital setting 2, UP/DOWN terminal given 4: Digital setting 3, serial port given 5: VI analog given (VI-GND) 6: CI analog given(CI-GND) 7: Pulse terminal given(PULSE) 8: Combination given (refer to P3.00)	1	0	○
P0.02	Running frequency set	P0.19lower limit freq.~P0.20upper limit freq.	0.01HZ	50.00HZ	○
P0.03	Running command mode selection	0: Control panel mode 1: Terminal control mode 2: Serial port control mode	1	0	○
P0.04	Running direction setting	Unit's digit: 0: Forward 1:Reverse Ten's digit: 0:REV allowed 1:REV prohibited	1	10	○
P0.05	FWD/REV dead time	0.0~120.0s	0.1s	0.1s	○
P0.06	Max output freq.	50.00Hz~500.00Hz	0.01Hz	50.00Hz	×
P0.07	Basic running freq	1.00Hz~500.00Hz	0.01Hz	50.00Hz	×

P0.08	Max output voltage	1~480V	1V	inverter rated voltage	×
P0.09	Torque boost	0.0%~30.0%	0.1%	2.0%	×
P0.10	Torque boost cut-off freq.	0.00Hz~Basic running freq.P0.07	0.00	50.00Hz	○
P0.11	Torque boost mode	0: Manual 1: Auto	1	0	○
P0.12	Carrier freq	1.0K~14.0K	0.1K	8.0K	×
P0.13	Acc/Dec mode selection	0: Linear Acc/Dec 1: Curve Acc/Dec	1	0	×
P0 Group: Basic running parameter					
Func Code	Name	Range	Min Unit	Factory default	Modify
P0.14	Time of S curve start stage	10.0%~50.0% (Acc/Dec time) P0.14+P0.15 ≤ 90%	0.1%	20.0%	○
P0.15	Time of S curve ascent stage	10.0%~80.0% (Acc/Dec time) P0.14+P0.15 ≤ 90%	0.1%	60.0%	○
P0.16	Acc/Dec time unit	0: Second 1: Minute	0	0	×
P0.17	Acc time 1	0.1~6000.0	0.1	20.0	○
P0.18	Dec time 1	0.1~6000.0	0.1	20.0	○
P0.19	Upper limit freq.	Lower limit freq. -Max output freq.P0.06	0.01Hz	50.00Hz	×
P0.20	Lower limit freq.	0.00Hz~Upper limit freq.	0.01Hz	0.00Hz	×
P0.21	Lower limit freq. Running mode	0: Running at lower limit freq 1: Stopping	1	0	×
P0.22	V/F curve setting	0: Constant torque curve 1: Reduced torque curve 1 (1.2 times the power) 2: Reduced torque curve 2 (1.7 times the power) 3: Reduced torque curve 3 (2.0 times the power) 4: Customized V/F curve	1	0	×
P0.23	V/F Freq.valueP3	P0.25 ~ P0.07 Basic running freq.	0.01Hz	0.00Hz	×
P0.24	V/F Volt.valueV3	P0.26 ~ 100.0%	0.1%	0.0%	×
P0.25	V/F Freq.valueP2	P0.27 ~ P0.23	0.01Hz	0.00Hz	×
P0.26	V/F Volt.valueV2	P0.28 ~ P0.24	0.1%	0.0%	×
P0.27	V/F Freq.valueP1	0.00~P0.25	0.01Hz	0.00Hz	×

	V/F Volt.valueV1	0~ P0.26	0.1%	0.0%	x
--	------------------	----------	------	------	---

P1 Group: Frequency setting function parameter					
Func Code	Name	Range	Min Unit	Factory default	Modify
P1.00	Analog filtering time constant	0.01~30.00s	0.01s	0.20s	o
P1.01	VI channel gains	0.01~9.99	0.01	1.00	o
P1.02	VI min given	0.00~P1.04	0.01Hz	0.00V	o
P1.03	Corresponding freq. to VI min given	0.00~Upper limit freq.	0.01Hz	0.00Hz	o
P1.04	VI max given	P1.04~10.00V	0.01V	10.00V	o
P1.05	Corresponding freq. to VI max given	0.00~Upper limit freq.	0.01Hz	50.00Hz	o

P1 Group: Frequency setting function parameter					
Func Code	Name	Range	Min Unit	Factory default	Modify
P1.06	CI channel gains	0.01~ 9.99	0.01	1.00	o
P1.07	CI min given	0.00~ P1.09	0.01V	0.00V	o
P1.08	Corresponding freq. to CI min given	0.00~Upper limit freq	0.01Hz	0.00Hz	o
P1.09	CI max given	P1.07 ~10.00V	0.01V	10.00V	o
P1.10	Corresponding freq.to CI max given	0.00~Upper limit freq	0.01Hz	50.00Hz	o
P1.11	Max input pulse freq	0.1~20.0K	0.1K	10.0K	o
P1.12	Pulse min given	0.0~P1.14(Pulse max given)	0.1K	0.0K	o
P1.13	Corresponding freq.to pulse min given	0.00~Upper limit freq	0.01Hz	0.00Hz	o
P1.14	Pulse max given	P1.12(Pulse min given)~P1.11(Max input pulse freq.)	0.1K	10.0K	o
P1.15	Corresponding freq.to pulse max given	0.00~Upper limit freq	0.01Hz	50.00Hz	o

P2 Group: Start/Brake function parameter					
Func	Name	Range	Min	Factory	Modify

Code			Unit	default	
P2.00	Start running mode	0: Start from start freq. 1: Brake first, then start from start freq. 2: Track speed, then start.	1	0	×
P2.01	Start freq.	0.40~20.00Hz	0.01H Z	0.50Hz	○
P2.02	Start freq. running duration	0.0~30.0s	0.1s	0.0s	○
P2.03	DC brake current as start	0~15%	1%	0%	○
P2.04	DC brake time as start	0.0~60.0s	0.1s	0.0s	○
P2.05	Stop mode	0: Dec 1: Free Stop 2: Dec+ DC brake	1	0	×
P2.06	Start freq. of DC brake as stop	0.0~15.00Hz	0.0Hz	3.00Hz	○
P2.07	DC brake time as stop	0.0~60.0s	0.1s	0.0s	○
P2.08	DC brake current as stop	0~15%	1%	0%	○

P3 Group :Auxiliary running parameter					
Func Code	Name	Range	Min Unit	Factory default	Modify
P3.00	Freq. control channel combination	0: VI+CI 1: VI-CI 2: External pulse given+VI+ control panel▲、▼key given 3: External pulse given-VI-control panel▲、▼key given 4: External pulse given+CI 5: External pulse given-CI 6: RS485 given+VI+ control panel▲、▼key given 7: RS485 given-VI-control panel▲、▼key given 8: RS485 given+CI+ control panel▲、▼key given 9: RS485 given-CI-control panel▲、▼key given 10: RS485 given+CI+ External pulse given	1	0	×

		<p>11: RS485 given—CI—External pulse given</p> <p>12: RS485 given+VI+External pulse given</p> <p>13: RS485 given—VI—External pulse given</p> <p>14: VI+CI+control panel▲、▼key given +digital given (P0.02)</p> <p>15: VI+CI—control panel▲、▼key given +digital given (P0.02)</p> <p>16: MAX (VI, CI)</p> <p>17: MIN (VI, CI)</p> <p>18: MAX (VI, CI, PULSE)</p> <p>19: MIN (VI, CI, PULSE)</p> <p>20: VI, CI(Availability except 0,VI prior)</p> <p>21: VI+ Terminal UP/DOWN</p> <p>22: CI+ Terminal UP/DOWN</p>			
P3.01	Parameter initialization setting	<p>LED unit's digit:</p> <p>0: All parameters are allowed to be modified.</p> <p>1: All parameters are not allowed to be modified except this parameter itself.</p> <p>2: All parameters are not allowed to be modified except P0.02 parameter and this parameter itself</p> <p>LED ten's digit:</p> <p>0: Inaction</p> <p>1: Factory default reset</p> <p>2: Clear history fault record</p>	1	0	×
P3 Group Auxiliary running parameter					
Func Code	Name	Range	Min Unit	Factory default	Modify
P3.02	Parameter copy	<p>0: Inaction</p> <p>1: Parameter upload</p> <p>2: Parameter download</p> <p>Note: only valid in remote control mode</p>	1	0	×
P3.03	Auto energy save running	<p>0: Inaction</p> <p>1: Action</p>	1	0	×

DGI300 - Degdrive

P3.04	AVR function	0: Inaction 1: Always action 2: Inaction only in Dec	1	0	×
P3.05	Slip compensation freq.	0~150%	1%	0%	×
P3.06	JOG running freq.	0.10~50.00Hz	0.01Hz z	5.00Hz	○
P3.07	JOG Acc time	0.1~60.0s	0.1s	20.0s	○
P3.08	JOG Dec time	0.1~60.0s	0.1s	20.0s	○
P3.09	Communication configuration	LED unit's place: baud rate selection 0: 1200BPS 1: 2400BPS 2: 4800BPS 3: 9600BPS 4: 19200BPS 5: 38400BPS LED ten's place: data format 0: 1-7-2 Format, without check 1: 1-7-1 Format, odd parity check 2: 1-7-1 Format, even parity check 3: 1-8-2 Format, without check 4: 1-8-1 Format, odd parity check 5: 1-8-1 Format, even parity check 6: 1-8-1 Format, without check LED hundred's place: communication mode 0: MODBUS, ASCII Mode 1: MODBUS, RTU Mode	1	005	×
P3.10	Local address	0~248 0: Broadcast address 248: Host address	1	1	×
P3 Group: Auxiliary running parameter					
Func Code	Name	Range	Min Unit	Factory default	Modify
P3.11	Communication overtime detection time	0.0~1000.0s 0.0: Function invalid	0.1s	0.0s	×
P3.12	Local response delay	0~1000ms	1	5ms	×
P3.13	Multi-running running proportion	0.01~1.00	0.01	1.00	×
P3.14	Acc time2	0.1~6000.0	0.1	20.0	○

DGI300 - Degdrive

P3.15	Dec time2	0.1~6000.0	0.1	20.0	○
P3.16	Acc time3	0.1~6000.0	0.1	20.0	○
P3.17	Dec time3	0.1~6000.0	0.1	20.0	○
P3.18	Acc time4	0.1~6000.0	0.1	20.0	○
P3.19	Dec time4	0.1~6000.0	0.1	20.0	○
P3.20	Acc time5	0.1~6000.0	0.1	20.0	○
P3.21	Dec time5	0.1~6000.0	0.1	20.0	○
P3.22	Acc time6	0.1~6000.0	0.1	20.0	○
P3.23	Dec time6	0.1~6000.0	0.1	20.0	○
P3.24	Acc time7	0.1~6000.0	0.1	20.0	○
P3.25	Dec time7	0.1~6000.0	0.1	20.0	○
P3.26	Multi-stage freq.1	Lower limit freq.- Upper limit freq.	0.01H z	5.00Hz	○
P3.27	Multi-stage freq.2	Lower limit freq.- Upper limit freq.	0.01H z	10.00Hz	○
P3.28	Multi-stage freq.3	Lower limit freq.- Upper limit freq.	0.01H z	20.00Hz	○
P3.29	Multi-stage freq.4	Lower limit freq.- Upper limit freq.	0.01H z	30.00Hz	○
P3.30	Multi-stage freq.5	Lower limit freq.- Upper limit freq.	0.01H z	40.00Hz	○
P3.31	Multi-stage freq.6	Lower limit freq.- Upper limit freq.	0.01H z	45.00Hz	○
P3.32	Multi-stage freq.7	Lower limit freq.- Upper limit freq.	0.01H z	50.00Hz	○
P3.33	Jump freq.1	0.00~500.00Hz	0.01H z	0.00Hz	×
P3.34	Jump freq.1range	0.00~30.00Hz	0.01H z	0.00Hz	×
P3.35	Jump freq.2	0.00~500.00Hz	0.01H z	0.00Hz	×
P3.36	Jump freq.2range	0.00~30.00Hz	0.01H z	0.00Hz	×
P3.37	Reserved	0000~9999	1	0000	×
P3.38	Zero frequency DC	0.0%~15.0%	0.1%	0.0%	×

	braking voltage				
P3.39	Set running time	0~65.535K hour	0.001 K	0.000K	○
P3.40	Total running time	0~65.535K hour	0.001 K	0.000K	*

P3 Group: Auxiliary running parameter					
Func Code	Name	Range	Min Unit	Factory default	Modify
P3.41	Inspection speed start wait time	00.0~60.0	0.1s	02.0 s	○
P3.42	Inspection speed and start the maximum output current level	00.0~150.0%	0.1%	100.0%	○
P3.43	Running display parameter selection1	00~15	1	00	○
P3.44	Stop display parameter selection2	00~15	1	00	○
P3.45	No unit display coefficient	0.1~60.0	0.1	29.0	○
P3.46	JOG/REV Switching control	0: Select the JOG point operation 1: Select the REV reverse operation	1	0	×

P4 Group: Terminal control function parameter					
Func Code	Name	Range	Min Unit	Factory default	Modify
P4.00	Input terminal X1 function selection	0: Idle terminal 1: Multi-stage speed control terminal 1 2: Multi-stage speed control terminal 2 3: Multi-stage speed control terminal 3 4: External FWD JOG control input 5: External REV JOG control input 6: Acc/Dec time terminal 1 7: Acc/Dec time terminal 2 8: Acc/Dec time terminal 3 9: 3-wire control 10: Free stop input (FRS) 11: External stop command 12: Stopping DC brake input	1	0	×

		<p>command DB</p> <p>13: Inverter running prohibited</p> <p>14: Freq. increase command(UP)</p> <p>15: Freq. decrease command(DOWN)</p> <p>16: Acc/Dec prohibited command</p> <p>17: External reset input (clear fault)</p> <p>18: Peripheral equipment fault input (normally open)</p> <p>19: Freq. control channel selection 1</p> <p>20: Freq. control channel selection 2</p> <p>21: Freq. control channel selection 3</p> <p>22: Command switched to terminal</p> <p>23: Running command control mode selection 1</p> <p>24: Running command control mode selection 2</p> <p>25: Swing frequency selection</p> <p>26: Swing frequency running reset</p> <p>27: Close loop invalid</p> <p>28: Simple PLC pause running command</p> <p>29: PLC invalid</p> <p>30: PLC Reset in stopping state</p> <p>31: Freq. switch to CI</p> <p>32: Counter trig signal input</p> <p>33: Counter clear input</p> <p>34: External interrupt input</p> <p>35: Pulse freq. input (only valid for X6)</p> <p>36: Fire mode</p>			
P4.01	Input terminal X2 function selection	Ditto	1	0	×
P4.02	Input terminal X3 function selection	Ditto	1	0	×
P4.03	Input terminal X4 function selection	Ditto	1	0	×
P4.04	Input terminal X5 function selection	Ditto	1	0	×
P4.05	Input terminal X6 function selection	Ditto	1	0	×
P4.06	Input terminal X7 function selection	Ditto	1	0	

DGI300 - Degdrive

P4.07	Input terminal X8 function selection	Ditto	1	0	
P4.08	FWD/REV running mode selection	0: 2-wire control mode 1 1: 2-wire control mode 2 2: 3-wire control mode 1 3: 3-wire control mode 2	1	0	×
P4.09	UP/DN Rate	0.01~99.99Hz/s	0.01	1.00Hz/s	○
P4.10	2-way open collector output terminal OC1 output selection	0: Inverter in running(RUN) 1: Freq. arrival signal(FAR) 2: Freq. level detected signal(FDT1) 3: Reserved 4: Overload pre-alarm signal(OL) 5: Under voltage locking(LU) 6: External fault stopping (EXT) 7: Output freq. upper limit(FH) 8: Output freq. lower limit(FL) 9: Inverter in zero speed running 10: Simple PLC stage running finish 11: A PLC running cycle finish 12: Set counts arrival 13: Specified counts arrival 14: Inverter ready for running(RDY) 15: Inverter fault 16: Start freq. running time 17: DC brake time when start 18: DC brake time when stop 19: Swing freq. upper/lower limit 20: Set running time arrival 21: Upper limit of pressure alarm signal 22: Lower pressure alarm signal	1	0	×
P4.11	2-way open collector output terminal OC2 output selection	Ditto	1	0	×
P4.12	Relay TA/TB/TC output selection	Ditto	1	15	×
P4.13	Relay RA/RB/RC output selection	Ditto	1	0	×
P4.14	Freq. arrival detection range	0.00~400.00Hz	0.01Hz	5.00Hz	○
P4.15	FDT1(freq. level)	0.00~Upper limit freq	0.01Hz	10.00Hz	○
P4.16	FDT1 lag	0.00~50.00Hz	0.01Hz	1.00Hz	○

DGI300 - Degdrive

P4.17	Analog output (AO1) selection	unit's place : Output freq.(0~upper limit freq.) 1: Output current(0~2 times motor rated current) 2: Output voltage(0~1.2 times inverter rated voltage) 3: Bus bar voltage 4: PID given 5: PID feedback 6: VI (0~10V) 7: CI(0~10V/4~20mA) ten's place: 0: 0~10V 1: 0~20mA 2: 4~20mA	01	00	○
P4.18	Analog output (AO1) gain	0.50~2.00	0.01	1.00	○
P4.19	Analog output (AO2) selection	unit's place : Output freq.(0~upper limit freq.) 1: Output current(0~2 times motor rated current) 2: Output voltage(0~1.2 times inverter rated voltage) 3: Bus bar voltage 4: PID given 5: PID feedback 6: VI (0~10V) 7: CI(0~10V/4~20mA) ten's place: 0: 0~10V 1: 0~20mA 2: 4~20mA	01	00	○
P4.20	Analog output (AO2) gain	0.50~2.00	0.01	1.00	○
P4.21	DO output terminal function selection	unit's place : 0: Output freq.(0~upper limit freq.) 1: Output current(0~2 times motor rated current) 2: Output voltage(0~1.2 times inverter rated voltage) 3: Bus bar voltage (0~800V) 4: PID given 5: PID feedback 6: VI (0~10V) 7: CI(0~10V/4~20mA)	1	0	○
P4.22	DO max pulse output freq.	0.1K~20.0K (max 20KHz)	0.1KH z	10.0KHz	○

DGI300 - Degdrive

P4.23	Set counts given	F4.20~9999	1	0	○
P4.24	Specified counts given	0~F4.19	1	0	○
P4.25	Overload pre-alarm detection level	20%~200%	1	130%	○
P4.26	Overload pre-alarm delay time	0.0~20.0s	0.1s	5.0s	○

P5 Group: Protection function parameter

Func Code	Name	Range	Min Unit	Factory default	Modify
P5.00	Motor overload protection mode selection	0: Stop outputting 1: Inaction	1	0	×
P5.01	Motor overload protection coefficient	20~120%	1	100%	×
P5.02	Overvoltage stall Selection	0: Prohibited 1: Allowed	1	1	×
P5.03	Overvoltage stall point	380V: 120~150% 220V: 110~130%	1%	140% 120%	○
P5.04	Auto current limit level	110%~200%	1%	150%	×
P5.05	Freq. drop rate during current limit	0.00~99.99Hz/s	0.01H z/s	10.00Hz/ s	○
P5.06	Auto current limit mode selection	0: Constant speed invalid 1: Constant speed valid Note: Acc/Dec valid	1	1	×
P5.07	Restart setting after power failure	0: Inaction 1: Action	1	0	×
P5.08	Restart waiting time after power failure	0.0~10.0s	0.1s	0.5s	×
P5.09	Fault self-recovery times	0~10 0: Self-recovery invalid Note: Self-recovery invalid in overload or overheat	1	0	×
P5.10	Self-recovery interval time	0.5~20.0s	0.1s	5.0s	×
P5.11	Input missing phase protection	0: Inaction 1: Action	1	0	○

P6 Group: Fault record function parameter

Func Code	Name	Range	Min Unit	Factory default	Modify
P6.00	Last fault record	Last fault record	1	0	*
P6.01	Output freq. in last fault	Output freq. in last fault	0.01Hz	0	*
P6.02	Set freq. in last fault	Set freq. in last fault	0.01Hz	0	*
P6.03	Output current in last fault	Output current in last fault	0.1A	0	*
P6.04	Set freq. in last fault	Set freq. in last fault	1V	0	*
P6.05	Output current in last fault	Output current in last fault	1V	0	*
P6.06	Output voltage in last fault	Output voltage in last fault	10C	0	*
P6.07	Last 2 fault record	Last 2 fault record	1	0	*
P6.08	Last 3 fault record	Last 3 fault record	1	0	*
P6.09	Last 4 fault record	Last 4 fault record	1	0	*
P6.10	Last 5 fault record	Last 5 fault record	1	0	*
P6.11	Last 6 fault record	Last 6 fault record	1	0	*

P7 Group: Close loop running control function parameter					
Func Code	Name	Range	Min Unit	Factory default	Modify
P7.00	Close loop running control selection	0: Invalid 1: Valid	1	0	x
P7.01	Close loop given channel selection	0: P7.05 Digital given + panel ▲、▼Fine tuning 1: VI analog 0~10V voltage given 2: CI analog 0~10V given 3: Panel analog potentiometer given 4: RS485 communication given 5: Pulse input given 6: CI simulation 4~20mA Current setting	1	0	x
P7.02	Feedback channel selection	0: VI analog 0~10V input voltage 1: CI analog input (0~10V/0~20mA) 2: VI+CI 3: VI-CI 4: Min {VI, CI} 5: Max {VI, CI} 6: CI analog input (4~20mA)	1	0	x

DGI300 - Degdrive

P7.03	Given channel filtering time constant	0.01~50.00s	0.01s	0.50s	○
P7.04	Feedback channel filtering time constant	0.01~50.00s	0.01s	0.50s	○
P7.05	Given value digital setting	0.001~20.000Mpa	0.001 Mpa	0.000Mpa a	×
P7.06	Close loop adjustment characteristics	0: Positive effect 1: Negative effect	1	0	○
P7.07	Feedback channel gain	0.01~10.00	0.01	1.00	○
P7.08	Lower pressure limit	0.001~P7.09	0.001	0.001	○
P7.09	Upper pressure limit	P7.08~P7.27	0.001	1.000	○
P7.10	PID Controller structure	0: Proportional control 1: Integral control 2: Proportional integral control 3: Proportional, integral and differential control	1	1	×
P7.11	Proportional gain KP	0.00~5.00	0.01	0.50	○
P7.12	Integral time constant	0.1~100.0s	0.1	10.0s	○
P7.13	Differential gain	0.0~5.0	0.1	0.0	×
P7.14	Sampling period	0.01~1.00s	0.01	0.10	○
P7.15	Tolerance limit	0.0~20.0%	0.1%	0.0%	○
P7.16	PID Feedback disconnected detection threshold	0~Upper limit freq	0.01Hz z	0.00Hz	○
P7.17	PID Feedback disconnected action selection	0~3	1	0	○
P7.18	PID Feedback disconnected operation delay time	0.01~5.00s	0.01s	1.00s	○
P7.19	Pressure level.	0.001~P7.20	0.001 Mpa	0.001Mpa a	○
P7.20	Hibernation pressure level	P7.19~P7.27	0.001 Mpa	1.000Mpa a	○

DGI300 - Degdrive

P7.21	Hibernation level continuous time	0~250s	1s	10s	○
P7.22	Hibernation frequency	0.00~400.0Hz	0.01Hz	20.00Hz	○
P7.23	Hibernation frequency continuous time	0~250s	1s	10s	○
P7.24	Low alarm limit pressure	0.001~P7.25	0.001 Mpa	0.001Mpa	○
P7.25	The alarm limit pressure	P7.24~P7.27	0.001 Mpa	1.000Mpa	○
P7.26	Constant pressure water supply mode	0: Non-constant pressure water supply mode 1: One pump constant pressure water supply mode 2: Two pumps constant pressure water supply mode 3: Three pumps constant pressure water supply mode 4: Four pumps constant pressure water supply mode	1	0	×
P7.27	Remote pressure gauge range	0.001~20.000Mpa	0.001 Mpa	1.000Mpa	○
P7.28	Multi pump operation mode	0: Fixed sequence switch 1: Timing of the rotation	1	0	○
P7.29	Rotation in timed intervals	0.5~100.0H	0.1H	5.0H	○
P7.30	Pump switching judgment time	0.1~1000.0s	0.1s	300.0s	×
P7.31	Electromagnetic switching delay time	0.1~10.0s	0.1s	0.5s	×
P7.32	PID Control of positive and negative role and feedback pressure error polarity	unit's place: 0: PID Control action 1: PID Control reaction ten's place: 0: Feedback pressure less than the actual pressure 1: Feedback pressure is greater than the actual pressure	1	00	×
P7.33	Feedback error of pressure adjustment coefficient	0.001~20.000Mpa	0.001 Mpa	0.000Mpa	×

				a	
P7.34	Closed loop of preset frequency	Range: 0~Upper limit freq	0.00H z	0.00Hz	x
P7.35	Closed loop of preset frequency holding time	Range: 0.0~200.0s	0.1s	0.0s	x

P8 Group PLC running parameter					
Func Code	Name	Range	Min Unit	Factory default	Modify
P8.00	PLC running mode selection	0000~1113 LED unit 's place: mode selection 0: Inaction 1: Stop after single cycle 2: Running at final freq after single cycle 3: Continuous cycle LED ten's place: restart mode selection 0: Restart from the first stage 1: Restart from the freq. of break stage 2: Restart from the running. of break stage LED hundred's place: parameter save mode selection 0: No save 1: Save LED thousand's place: running time unit 0: Second 1:minute	1	0000	x
P8.01	Stage 1 setting	000~621 LED unit 's place: freq setting 0: Multi-stage freq i (i=1~7) 1: Freq. defined by P0.01 function code LED ten's place: direction selection 0: Forward 1: Reverse 2: Controlled by running command LED hundred's place: Acc/Dec time selection 0: Acc/Dec time 1 1: Acc/Dec time 2	1	000	o

		2: Acc/Dec time 3 3: Acc/Dec time 4 4: Acc/Dec time 5 5: Acc/Dec time 6 6: Acc/Dec time 7			
P8.02	Stage 1 running time	0.1~6000.0	0.1	10.0	○
P8.03	Stage 2 setting	000~621	1	000	○
P8.04	Stage 2 running time	0.1~6000.0	0.1	10.0	○
P8.05	Stage 3 setting	000~621	1	000	○
P8.06	Stage 3 running time	0.1~6000.0	0.1	10.0	○
P8.07	Stage 4 setting	000~621	1	000	○
P8.08	Stage 4 running time	0.1~6000.0	0.1	10.0	○
P8.09	Stage 5 setting	000~621	1	000	○
P8.10	Stage 5 running time	0.1~6000.0	0.1	10.0	○
P8.11	Stage 6 setting	000~621	1	000	○
P8.12	Stage 6 running time	0.1~6000.0	0.1	10.0	○
P8.13	Stage 7 setting	000~621	1	000	○
P8.14	Stage 7 running time	0.1~6000.0	0.1	10.0	○

P9 Group Swing frequency function parameter					
Func Code	Name	Range	Min Unit	Factory default	Modify
P9.00	Swing freq. selection	0: Inaction 1: Action	1	0	×
P9.01	Swing freq. running mode	0000~11 LED unit's place: start mode 0: Auto start 1: Manual start by terminal LED ten's place: swing amplitude control 0: Variable swing amplitude 1: Fixed swing amplitude	1	00	×
P9.02	Preset swing freq.	0.00~500.00Hz	0.01Hz	0.00Hz	○
P9.03	Preset swing freq. waiting time	0.0~3600.0s	0.1s	0.0s	○
P9.04	Swing amplitude	0.0~50.0%	0.1%	0.0%	○
P9.05	Kick freq.	0.0~50.0%	0.1%	0.0%	○
P9.06	Swing freq. cycle	0.1~999.9s	0.1s	10.0s	○

DGI300 - Degdrive

P9.07	delta wave ascent time	0.0~98.0%	0.1%	50.0%	○
P9.08	Terminal UP/DOWN and Fan control selection	000~111	1	00	○
P9.09	Multi-function terminal filtering time	Range: 0~4	1	1	○
P9.10	Braking unit use rate	0~100.0%	0.1%	30.0%	○
P9.11	Overpressure threshold value	0~780V	1V	780V	○
P9.12	Energy consumption braking bus bar voltage	0~780V	1V	640V Or 358V	○
P9.13	G, P Model set	0, 1	1	0	○
P9.14	User password	1~9999	1	0	○

PA Group: Vector control parameter					
Func Code	Name	Range	Min Unit	Factory default	Modify
PA.00	Motor parameter Auto tuning function	0: Inaction 1: Static auto tuning	1	0	×
PA.01	Motor rated voltage	0~400V	1	depends on model type	×
PA.02	Motor rated current	0.01~500.00A	0.01A	depends on model type	×
PA.03	Motor rated frequency	1~500Hz	1Hz	depends on model type	×
PA.04	Motor rated rotating speed	1~9999 r/min	1r/min	depends on model type	×
PA.05	Motor poles number	2~16	1	depends on model type	×
PA.06	Motor stator inductance	0.1~5000.0mH	0.1mH	depends on model type	×
PA.07	Motor rotor inductance	0.1~5000.0mH	0.1mH	depends on model type	×
PA.08	Motor stator and rotor mutual inductance	0.1~5000.0mH	0.1mH	depends on model	×

PA.09	Motor stator resistance	0.001~50.000Ω	0.001 Ω	type depends on model type	×
PA.10	Motor rotor resistance	0.001~50.000Ω	0.001 Ω	depends on model type	×
PA.11	Over current protection coefficient of torque current	0~15	1	15	×
PA.12	Proportion adjustment coefficient of speed deviation	50~120	1	85	×
PA.13	Integral adjustment coefficient F speed deviation	100~500	1	360	×
PA.14	Vector torque boost	100~150	1	100	×
PA.15	Reserved	0	0	0	×
PA.16	Reserved	1~5	1	4	×
PA.17	Reserved	100~150	1	150	×
PA.18	Reserved	150	1	150	×
PA.19	Reserved	0~2	1	0	

PF Group: Factory function parameter					
Func Code	Name	Range	Min Unit	Factory default	Modify
PF.00 ~ PF.10	Reserved	—	—	—	—

5.3 State Monitoring Parameter Table

B-Monitoring: function parameter					
Func Code	Name	Range	Min Unit	Factory default	Modify
b-00	Output freq	Present output freq	0.01H z		*
b-01	Set freq.	Present set freq.	0.01H z		*
b-02	Output voltage	Effective value of present output voltage	1V		*

b-03	Output current	Effective value of present output current	0.1A		*
b-04	Bus bar voltage	Present DC bus bar voltage	1V		*
b-05	Module temperature	IGBT heat sink temperature	10C		*
b-06	Motor speed	Present motor speed	1r/min		*
b-07	Running time	One continuous running time	1H		*
b-08	Input/output terminal state	Input/output terminal state	—		*
b-09	Analog input VI	Analog input VI value	0.01V		*
b-10	Analog input CI	Analog input CI value	0.01V		*
b-11	External pulse input	External pulse width input value	1ms		*
b-12	Inverter rated current	Inverter rated current	0.1A		*
b-13	Inverter rated voltage	Inverter rated voltage	1V		*
b-14	Set pressure	Water supply control when the set pressure of the pipeline	0.001 Mpa		
b-15	Feedback pressure	Water supply control feedback pipeline pressure	0.001 Mpa		
b-16	No unit display	No unit display	1		

5.4 Terminal Monitoring State

Note: Monitoring parameter input/output terminal state displayed as follow:

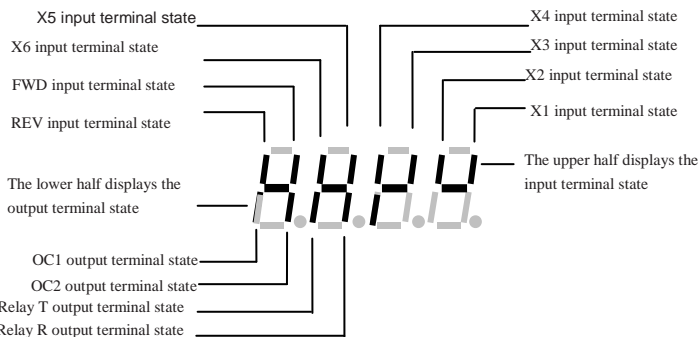

Note: " " Means invalidity ((LED OFF)) " " Means validity (LED ON)

Chapter 6 Function Code Description

6.1 Basic running function parameter (P0 Group)

P0.00	Control mode selection	Range: 0/1	1
--------------	-------------------------------	-------------------	----------

0: V/F Control

1: Sensorless vector control

P0.01	Freq. control channel selection	Range: 1~8	0
--------------	--	-------------------	----------

0: Analog potentiometer given on control panel

1: Control panel ▲, ▼ key given. Use ▲, ▼ key to set running frequency.

2: Control panel frequency digital setting. Use control panel to amend P0.02 parameter (initial set freq.) to change set freq.

3: Terminal UP/DOWN digital setting. Use terminal UP/DOWN to amend P0.02 parameter (initial set freq.) to change set freq.

4: Serial port digital setting. (Remote control mode) Set P0.02 parameter (initial set freq.) via serial port.

5: VI analog given (VI-GND). Set freq. controlled by VI terminal analog input voltage. The voltage range is DC 0~10V. The corresponding relationship between set freq. and VI input voltage defined by function code P1.00~P1.05.

6: CI analog given (CI-GND). Set freq. controlled by CI terminal analog input voltage/current. The input voltage range is DC 0~10V (JP3 jumper V), and the current range is DC 4~20mA (JP3 jumper A). The corresponding relationship between set freq. and CI input defined by function code P1.06-P1.10

7: Pulse terminal given. Set freq. controlled by terminal pulse (The pulse signal only can be input through X4 terminal.). The corresponding relationship between set freq. and input pulse defined by function code P1.11-P1.15.

8: Combination given (refer to function parameter P3.00).

P0.02	Initial digital set freq.	Range: Lower limit freq. ~ Upper limit freq.	50.00Hz
--------------	----------------------------------	---	----------------

When Freq control channel selection setting (P0.01=1, 2, 3, 4), P0.02 parameter defines the initial digital set frequency.

P0.03	Running command mode selection	Range: 0, 1,2	0
--------------	---------------------------------------	----------------------	----------

0: Use control panel key RUN, STOP/RESET, JOG to operate the inverter.

1: Terminal control mode. Use control terminal FWD, REV, X1~X6, etc. to operate the inverter.

2: Serial port control mode. Operate the inverter via serial port RS485 in remote control mode.

Note:

Running command mode can be switched by changing P0.03 parameter in stopping or running state. Please use this function in caution.

P0.04	Running direction setting	Range: 00~11	0
--------------	----------------------------------	---------------------	----------

This function is effective in panel control mode, terminal control mode, and serial port control mode.

LED unit's digit:

0: Running forward

1: Running reverse

LED ten's digit:

0: Reverse allowed

1: Reverse prohibited

P0.05	FWD/REV dead time	Range: 0.0~120.0s	0.0s
--------------	--------------------------	--------------------------	-------------

In switching process between forward and reverse running, the transition time as Fig.6-1 t_1 is defined as FWD/REV dead time. The inverter outputs 0 freq. during transition time.

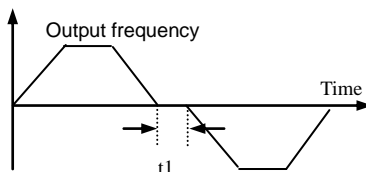

Fig.6-1 FWD/REV dead time

P0.06	Max. output freq.	range: 50.00Hz~500.0Hz	50.00Hz
P0.07	Basic running freq.	range: 1.00Hz~500.00Hz	50.00Hz
P0.08	Max. output voltage Rated voltage	range: 1~480V	Rated voltage

Max. output freq. is inverter highest output frequency allowed shown as Fig. 6-2 F_{max} .

Basic running freq. is the lowest output frequency corresponding to the highest output voltage of inverter. Generally, it is motor rated frequency shown as Fig.6-2 F_B .

Max. output voltage is the output voltage corresponding to inverter outputs basic running frequency. Generally, it is motor rated voltage shown as Fig.6-2 A_{max} .

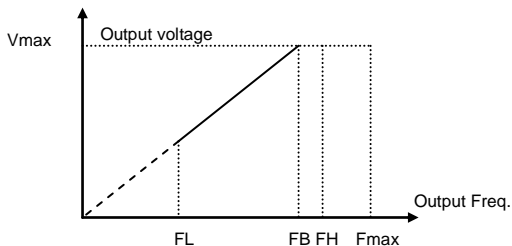

Fig.6-2 $F_{max}/F_B/V_{max}0V$

F_H, F_L are the upper limit frequency and lower limit frequency, defined by P0.19, P0.20 function parameter.

P0.09	Torque boost	Range: 0.0%~30.0%	2.0%
-------	--------------	-------------------	------

In order to compensate the low frequency torque, boost the output voltage in the low frequency zone shown as Fig.6-3.

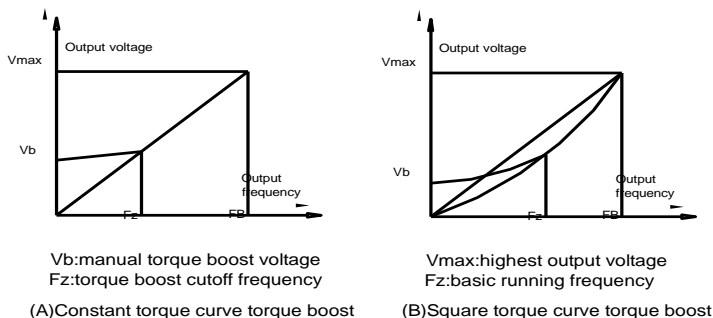

Fig.6-3 Torque boost

P0.10	Torque boost cutoff freq.	Range : 0.00Hz~basic running freq.	25.00Hz
--------------	--------------------------------------	---	----------------

This function defines the cutoff freq. in manual torque boost shown as Fig.6-3 Fz. This parameter is adaptable to any V/F mode defined by P0.22.

P0.11	Torque boost mode	Range: 0 , 1	0
--------------	--------------------------	---------------------	----------

0: Manual boost. In manual boost mode, torque boost voltage is defined by P0.09 parameter, which is fixed. But the motor is easy to reach magnetic saturation in light-load.

1: Auto. boost. In this mode, torque boost voltage changes according to motor stator current changing. The higher of stator current, the bigger of boost voltage reaches.

$$\text{Boost voltage} = \frac{P0.09}{100} \times \text{Motor rated voltage} \times \frac{\text{Inverter output current}}{2 \times \text{Inverter rated current}}$$

P0.12	Carrier freq.	Range: 1.0K~14.0K	8.0K
-------	---------------	-------------------	------

The carrier freq. mainly affects the noise of motor and heat loss. The relationship between carrier freq. and motor noise, leakage current, and interference shown as follow.

Carrier Freq.	Decrease	Increase
Noise	↑	↓
Leakage Current	↓	↑
Interference	↓	↑

Note:

(1) In order to get better control characteristic, the ratio of carrier frequency to inverter highest running frequency is suggested beyond 36.

(2) Difference may occur in current value display, when carrier freq. is low.

P0.13	Acc/Dec mode selection	Range: 0, 1	0
-------	------------------------	-------------	---

0: Linear Acc/Dec. Output frequency increases or decreases as constant slope shown as Fig.6-4.

1: S curve Acc/Dec. Output frequency increases or decreases as s curve shown as Fig.6-5.

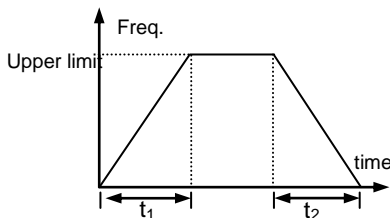

Fig.6-4 Linear Acc/Dec

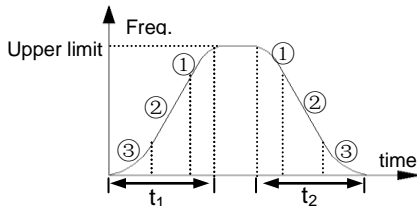

Fig.6-5 S curve Acc/Dec

P0.14	Time of s curve start stage	Range: 10.0%~50.0% (Acc/Dec), P0.14+P0.15<90%	20.0%
P0.15	Time of s curve ascent stage	Range: 10.0%~80.0% (Acc/Dec), P0.14+P0.15<90%	60.0%

P0.14, P0.15 is effective only in s curve Acc/Dec mode(P0.13=1).

S curve start stage time shown as Fig.6-5(3). The curve slope is increasing from 0.

S curve ascent stage time shown as Fig.6-5(2). The curve slope keeps constant.

S curve end stage time shown as Fig.6-5(1). The curve slope is decreasing to 0.

Note:

S curve Acc/Dec mode is suitable for the starting and stopping process of conveying load such as elevator and belt conveyor, etc.

P0.16	Acc/Dec time unit	Range: 0, 1	0
-------	-------------------	-------------	---

0: Second

1: Minute

Note:

(1) This function is effective for all Acc/Dec process except for JOG running mode.

(2) Please try to select second as time unit.

P0.17	Acc time 1	Range: 0.1~6000.0	20.0
P0.18	Dec time 1	Range: 0.1~6000.0	20.0

Acc time is the time of inverter output frequency increasing from 0 to upper limit freq. shown as in Fig.6-6 t1.

Dec time is the time of inverter output frequency decreasing from upper limit freq. to 0 shown as Fig.6-6 t2.

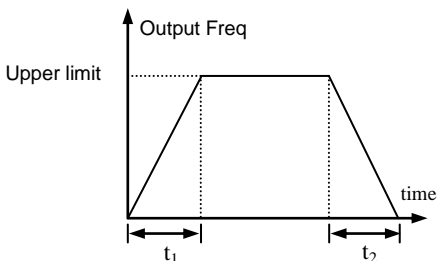

Fig.6-6 Acc/Dec time

Note:

- (1) The inverter has 7 Acc/Dec time. Herein just 1 Acc/Dec is defined. The other 2~7 Acc/Dec time are defined by P3.14~P3.25 function parameter.
- (2) It can select time unit by P0.09 for all 1~7 Acc/Dec time. The factory default setting unit is second.

P0.19	Upper limit freq.	Range: Lower limit freq. ~ highest output freq.	50.00Hz
P0.20	Lower limit freq.	Range: 0.00Hz ~ Upper limit freq.	0.00HZ
P0.21	Lower limit freq. running mode	Range: 0: running at lower limit freq. 1: stopping	0

P0.19,P0.20 parameter defines the upper and lower limit of output frequency. FH,FL is upper limit frequency and lower limit frequency respectively shown as Fig.6-2.

When actual setting frequency is lower than lower limit freq., the inverter output frequency will decrease in Dec time which has been set. As it reaches the lower limit frequency, if P0.21=0, the inverter will run at lower limit frequency. If P0.21=1, the inverter will keep decreasing the output frequency to 0.

P0.22	V/F curve setting	Range: 0~4	0
P0.23	V/F Freq. F3	Range: P0.25-P0.07 basic Freq.	0.00Hz
P0.24	V/F Volt. V3	Range: P0.26 ~ 100.0%	0.0%

P0.25	V/F Freq. F2	Range: P0.27 ~ P0.23	0.00Hz
P0.26	V/F Volt. V2	Range: P0.28 ~ P0.24	0.0%
P0.27	V/F Freq. F1	Range: 0.00~P0.25	0.00Hz
P0.28	V/F Volt.V1	Range: 0~ P0.26	0.0%

These function parameter defines flexible V/F setting mode of inverter. User can select 4 fixed curves and 1 customized curve through P0.22 parameter so as to meet different load requirements.

P0.22=0, Constant torque V//F curve shown as Fig.6-7 curve 0

P0.22=1, 1.2 times the power reduced torque V/F curve shown as Fig.6-7 curve 1

P0.22=2, 1.7 times the power reduced torque V/F curve shown as Fig.6-7 curve 2

P0.22=3, 2.0 times the power reduced torque V/F curve shown as Fig.6-7 curve 3

When inverter drives reduced torque load such as fans, and pumps, user can select 1/2/3 V/F curve running mode according to load characteristic for energy saving.

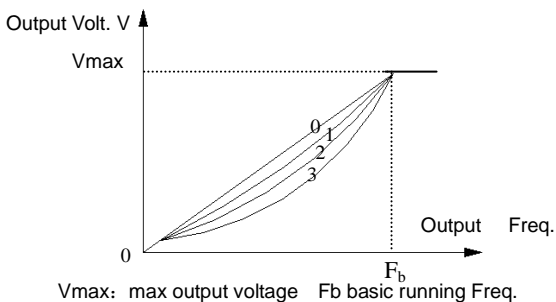

Fig 6—7 V/Curve



图 6—8 customized V/Fcurve

P0.22=4, Customized V/F curve shown as Fig. 6-8.

User can define V/F curve through revising (V1,F1),(V2,F2),(V3,F3) so as to meet special load requirements. Torque boost is available for customized curve.

$$Vb = \text{Torque boost (P0.09)} \times V1$$

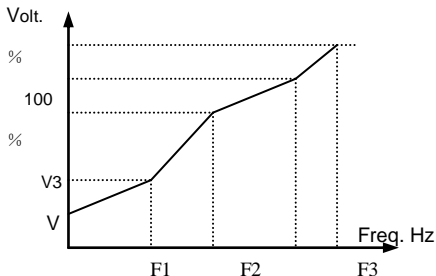
6.2 Frequency Setting Function Parameter (PP11 Group)

P1.00	Analog filter time constant	Range: 0.01~30.00s	0.20s
--------------	------------------------------------	---------------------------	--------------

When adopts frequency external analog channel setting mode, time constant is inverter filtering sampling value time. When long distance wiring or serious interference cause setting frequency unstable, increase this time constant to avoid the disoperation . The longer filtering time, anti-interference ability will be stronger. But the response will be slower. The shorter filtering time it has, the quicker response, but weaker anti-interference ability.

P1.01	VI channel gains	Range: 0.01~9.99	1.00
P1.02	VI min.given	Range: 0.00~P1.04	0.00V
P1.03	Corresponding freq to VI min.given	Range: 0.00~upper limit freq	0.00Hz
P1.04	VI max.given	Range: P1.04~10.00V	10.00V
P1.05	Corresponding freq to VI max.given	Range: 0.00~upper limit freq	50.00Hz
P1.06	CI channel gains	Range: 0.01~ 9.99	1.00
P1.07	CI min. given	Range: 0.00~ P1.09	0.00V
P1.08	Corresponding freq to CI min.given	Range: 0.00~upper limit freq	0.00Hz

P1.09	Clmax. Given	Range: P1.07 ~10.00V	10.00V
P1.10	Corresponding freq to Cl max.given	Range: 0.00~upper limit freq	50.00Hz
P1.11	Max. input PLUSE freq	Range: 0.1~20.0K	10.0K
P1.12	PLUSE min given	Range: 0.0~P1.14	0.0K
P1.13	Corresponding freq to pulse min.given	Range: 0.00~upper limit freq	0.00Hz
P1.14	Pulse max.given	Range: P1.12~P1.11	10.0K
P1.15	Corresponding freq to pulse max.given	Range: 0.00~upper limit freq	50.00Hz

When selects VI, CI or pulse frequency input as open loop frequency setting channel, the relationship between frequency given and setting frequency as follow:

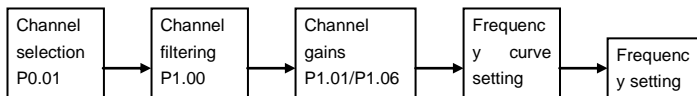

The relationship between VI and setting frequency is as follow.

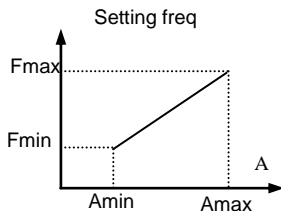

(1) Positive effect

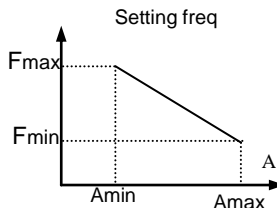

(2) Negative effect

A: VI given

Amin: Min
Amax: Max

Fmin: corresponding Freq to Min given
Fmax: corresponding Freq to Max given

after momentary power failure and restart after fault reset.

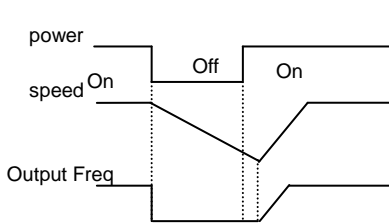

Fig.6-9 Speed tracking restart

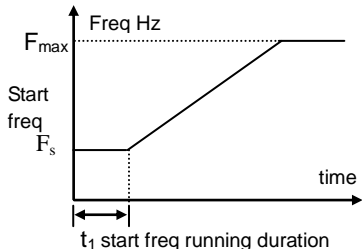

Fig.6-10 Start freq. and running duration

Note:

- (1) Start running mode 0: It is suggested to use mode 0 in general applications and when to drive synchronous motor.
- (2) Start running mode 1: It is suitable to small inertia loads which have FWD or REV running when there is no motor driven. But not suitable to big inertia loads.
- (3) Start running mode 2: It is suitable to restart after momentary power failure and restart during motor free stopping.

P2.01	Start freq	Range: 0.20~10.00Hz	0.50 Hz
P2.02	Start freq. running duration	Range: 0.0~30.0S	0.0S

Start freq. is the initial frequency when inverter starts shown as Fig.6-10 F_s . Start freq. running duration is the duration time for inverter keeping running at start frequency shown as Fig.6-10

Notes:

Start frequency is not restricted by lower limit freq

P2.03	DC brake current as start	Range: 0~15(%)	0(%)
P2.04	DC brake time as start	Range: 0.0~60.0S	0.0S

DC brake current is a percentage relative to the inverter rated current. There is no DC brake as DC brake time is 0.0s.

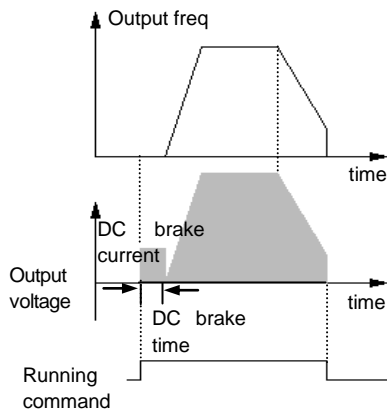
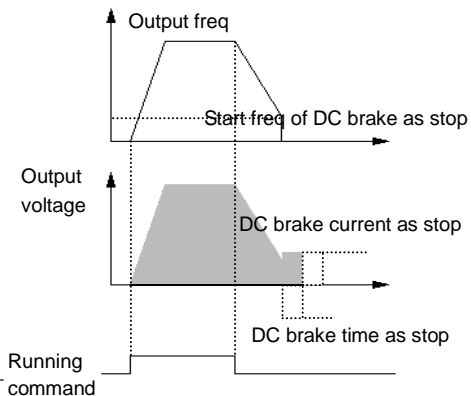
Fig.6-11 start mode 1

Fig.6-12 DC stop and DC brake

P2.05	Stop mode	Range: 0, 1, 2	0
--------------	------------------	-----------------------	----------

0: After receiving stop command, the inverter decreases the output frequency to 0 in set Dec time.

1: After receiving stop command, the inverter stops output immediately, and the load goes to stop by mechanical inertia. This is called as coast stop.

2: After receiving stop command, the inverter decreases the output frequency in Dec time, when it reaches the start frequency of DC brake, the inverter begins to DC brake,

P2.06	Start freq. of DC brake as stop	Range: 0.0~15.00Hz	3.00Hz
P2.07	DC brake time as stop	Range: 0.0~60.0S	0.0S
P2.08	DC brake current as stop	Range: 0~15 (%)	0(%)

DC brake current as stop is a percentage relative to the inverter rated current. There is no DC brake when DC brake time is 0.0s. .

6.4 Auxiliary Running Parameter ((P3 Group)

P3.00	Freq. control channel combination	Range: 0~20	0
--------------	--	--------------------	----------

As P0.01(frequency control channel selection)=8, It can set frequency control channel combination through the above parameter (P3.00).

0: VI+CI

1: VI-CI

2: external pulse given +V1+ control panel ▲、▼key given

3: external pulse given +V1+ control panel ▲、▼key given

4: external pulse given +CI

5: external pulse given -CI

6: RS485 given +VI + control panel ▲、▼key given

7: RS485 given -VI -control panel ▲、▼key given

8: RS485given +CI+ control panel ▲、▼key given

9: RS485given -CI-control panel ▲、▼key given

10: RS485given +CI+external pulse given

11: RS485given -CI-external pulse given

12: RS485 given +VI+external pulse given

13: RS485 given -VI-external pulse given

14: VI +CI+control panel ▲、▼key given + digital given P0.02

15: VI +CI-control panel ▲、▼key given + digital given P0.02

16: MAX (VI, CI)

17: MIN (VI, CI)

18: MAX (VI, CI, PLUSE)

19: MIN (VI, CI, PLUSE)

20: VI, CI availability except. VI prior

21: VI+Terminal UP/ DOWN

22: CI+Terminal UP/ DOWN

P3.01	Parameter initialization setting	Range: LED unit's digit 0~2 LED ten's digit 0~2	00
--------------	---	--	-----------

LED unit's digit

0: All parameters are allowed to be revised

1: All parameters are not allowed to be revised except this parameter itself

2: All parameters are not allowed to be revised except P0.02 parameter and this parameter itself.

LED ten's digit

0: inaction

1: Factory default reset

2: Clear history fault record

Note:

(1) The factory default setting of this function code parameter is 0, that is all the function code parameter are allowed to be revised.

(2) After factory default reset, each place of this function code recovers to 0 automatically.

P3.02	Parameter copy	Range: 0, 1, 2	0
--------------	-----------------------	-----------------------	----------

0: inaction

1: Parameter upload: upload function code parameter to remote control

2: Parameters download: download function code parameter from remote control

Note:

This feature is only available for the remote control. Parameters are automatically restored to 0 after executing upload or download.

P3.03	Auto energy saving running	Range: 0, 1	0
--------------	-----------------------------------	--------------------	----------

0: inaction

1: action

When motor is running with light load or no-load, the inverter will detect the load current and adjust output voltage appropriately so as to save energy. This function is mainly used in application with stable load and running speed.

P3.04	AVR function	Range: 0, 1, 2	0
--------------	---------------------	-----------------------	----------

This is auto voltage regulation function. When inverter input voltage is fluctuating, use this function to keep inverter output voltage stable.

When inverter is decelerating to stop, if AVR function is invalid, the Dec. Time is going to be shorter. But it will output a higher running current. If AVR is effective, the motor will be decelerating stably with lower running current, but the Dec. Time becomes longer.

0: inaction

1: always action

2: inaction only in deceleration

P3.05	Slip freq. compensation	Range: 0~150(%)	0(%)
--------------	--------------------------------	------------------------	-------------

This function can regulate the output frequency appropriately according to the load, which can dynamically compensate the slip frequency of asynchronous motor so as to control the speed at a stable value. If use this function in conjunction with auto. torque boost function, It can achieve better low speed torque characteristic, which is shown as Fig.6-13

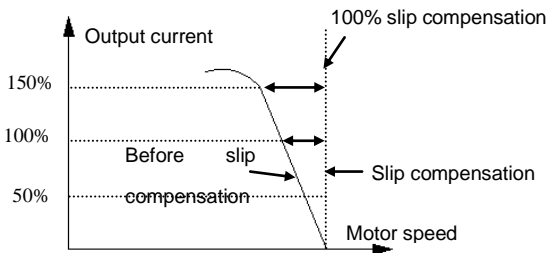

Fig.6-13 slip freq. compensation

P3.06	JOG running freq.	Range: 0.10~50.00Hz	5.00Hz
P3.07	JOG Acc time	Range: 0.1~60.0S	20.0S
P3.08	JOG Dec time	Range: 0.1~60.0S	20.0S

JOG frequency has the highest priority. In any stage, as long as there is a JOG command input, the inverter will switch to JOG frequency running by JOG Acc/Dec time immediately, which is shown as Fig.6-14

JOG Acc time is the time for inverter accelerating from 0 to upper limit freq.

JOG Dec time is the time for inverter decelerating from upper limit freq. to 0.

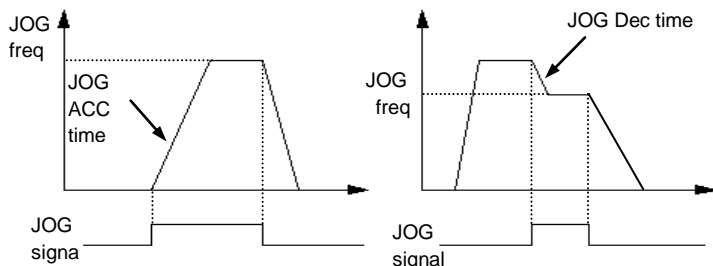

Fig.6-14 JOG running

Note:

- (1) JOG running is available in panel control mode, terminal and serial port control mode.
- (2) After JOG running command is canceled, the inverter will decelerate by Dec time.

P3.09	Communication configuration	Range: 000~155	0
--------------	------------------------------------	-----------------------	----------

User can configure the baud rate, data format and communication mode by setting P3.09 LED unit's digit (baud rate):

0: 1200BPS

1: 2400BPS

2: 4800BPS

3: 9600BPS

4: 19200BPS

5: 38400BPS

LED ten's digit (data format):

0: 1-7-2 Format, without check; 1-initial place, 7-data place, 2-stop place, without check.

1: 1-7-1 Format, odd parity check; 1-initial place, 7-data place, 1-stop place, odd parity check.

2: 1-7-1 Format, even parity check; 1-initial place, 7-data place, 1-stop place, even parity check

3: 1-8-2 Format, without check; 1-initial place, 8-data place, 2-stop place, without check.

4: 1-8-1 Format, odd parity check; 1-initial place, 8-data place, 1-stop place, odd parity check

5: 1-8-1 Format, even parity check; 1-initial place, 8-data place, 1-stop place, even parity check.

6: 1-8-1 Format, even parity check; 1-initial place, 8-data place, 1-stop place, without check.

LED hundred's digit (communication mode):

0: MODBUS, ASCII Mode: MODBUS communication protocol, ASCII data transmission

1: MODBUS, RTU Mode: MODBUS communication protocol, RTU data transmission

Note:

When ASCII mode is selected, please select data format as 0~2, that data place is 7.

When RTU mode is selected, please select data format as 3~5, that data place is 8.

P3.10	Local adress	Range: 0~248	1
-------	--------------	--------------	---

This function is used to mark the address of inverter itself in serial port communication mode.

0 Broadcast address. When the inverter works as a slave, if it receives address command as 0, it means the inverter is receiving broadcast command and unnecessary to respond the host.

248 Host address. When the inverter works as a host, set P3.10=248, the host inverter is able to send broadcast command to other slave inverters so as to achieve multi-machine interaction.

P3.11	Communication overtime detection time	Range: 0.0~1000.0S	0.0S
--------------	--	---------------------------	-------------

When serial port communication is failed, if the duration exceeds the set value of this function, the inverter will conclude that there is a communication failure.

As set value is 0, the inverter will not detect the serial port communication signal, that this function is invalid.

P3.12	Local response delay	Range: 0~1000ms	5ms
--------------	-----------------------------	------------------------	------------

Local response delay is the time from serial port receiving the command from the upper computer and executing the command to responding the upper computer.

P3.13	Multi-running proportion	Range: 0.01~1.00	1.00
--------------	-------------------------------------	-------------------------	-------------

This function code is used to set the scale factor of inverter received frequency set command through serial port. The actual inverter running frequency is equal to this scale factor multiplied by received frequency set command through serial port.

In multi-machine interaction running mode, it can use this parameter to set the scale of multi-inverter running frequency. That is different running freq.

P3.14	Acc time2	Range: 0.1~6000.0	20.0
--------------	------------------	--------------------------	-------------

P3.15	Dec time2	Range: 0.1~6000.0	20.0
P3.16	Acc time3	Range: 0.1~6000.0	20.0
P3.17	Dec time3	Range: 0.1~6000.0	20.0
P3.18	Acc time 4	Range: 0.1~6000.0	20.0
P3.19	Dec time 4	Range: 0.1~6000.0	20.0
P3.20	Acc time 5	Range: 0.1~6000.0	20.0
P3.21	Dec time 5	Range: 0.1~6000.0	20.0
P3.22	Acc time 6	Range: 0.1~6000.0	20.0
P3.23	Dec time 6	Range: 0.1~6000.0	20.0
P3.24	Acc time 7	Range: 0.1~6000.0	20.0
P3.25	Dec time 7	Range: 0.1~6000.0	20.0

This function can define seven kinds of Acc/Dec time. It can select 1~7 kind of Acc/Dec time during running process by different combination of control terminal (Please refer to P4.00~P4.05).

P3.26	Multi-stage freq.1	Range: Lower limit freq.~Upper limit freq.	5.00Hz
P3.27	Multi-stage freq.2	Range: Lower limit freq.~Upper limit freq.	10.00Hz
P3.28	Multi-stage freq.3	Range: Lower limit freq.~Upper limit freq.	20.00Hz
P3.29	Multi-stage freq.4	Range: Lower limit freq.~Upper limit freq.	30.00Hz
P3.30	Multi-stage freq.5	Range: Lower limit freq.~Upper limit freq.	40.00Hz
P3.31	Multi-stage freq.6	Range: Lower limit freq.~Upper limit freq.	45.00Hz
P3.32	Multi-stage freq.7	Range: Lower limit freq.~Upper limit	50.00Hz

		freq.	
--	--	-------	--

These setting frequency can be used in multi-stage speed running mode and PLC simple running mode (please refer to P.00~P4.05 and P8 group).

P3.33	Jump freq.1	Range: 0.00—500.00Hz	0.00Hz
P3.34	Jump freq.1 range	Range: 0.00—30.00Hz	0.00Hz
P3.35	Jump freq.2	Range: 0.00—500.00Hz	0.00Hz
P3.36	Jump freq.2 range	Range: 0.00—30.00Hz	0.00Hz

This function is used for the inverter to avoid the resonance frequency of mechanical load.

The inverter setting frequency is able to do jump running near some frequency point shown as Fig.6-14. It can set 3 jump ranges at most. .

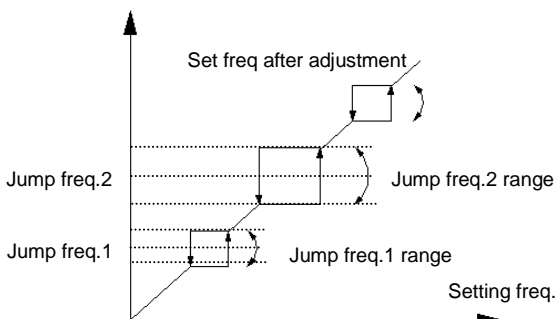

Fig.6-15 Jump frequency and range

P3.37	Reserved	Range: 0000—9999	0000
P3.38	DC brake current at 0 freq	Range: 0.0%~15.0%	0.0%

DC brake at 0 freq means inverter output DC voltage to brake motor while freq is 0. Users can adjust P3.38 to get larger braking force, but the current will be larger. .

P3.39	Set running time	Range: 0~65.535Kh	0.000K
P3.40	Total running time	Range: 0~65.535Kh	*

As total running time reaches set running time, the inverter will output index signal (refer to P4.08~P4.09).

P3.40 function code defines the total running time of inverter from factory delivery to present.

P3.41	Waiting time for restart	Range: 00.0~60.0s	2.0S
--------------	---------------------------------	--------------------------	-------------

P3.41 is used for setting waiting time for restart at 0 freq. when restart failed, adjusting the parameter to restart.

P3.42	Output current of restart	Range: 00.0~150.0%	100.0%
--------------	----------------------------------	---------------------------	---------------

P3.42 Is used to limit the maximum output current of restart for protection.

P3.43	Displayed parameter selection 3	Range: 00~15	00
--------------	--	---------------------	-----------

This function is used for LED displayed parameter when inverter running. 0-15 relate to monitoring parameter b-01 to b-15. For example, output current will displayed on LED when setting P3.43=03. Users can monitor other parameters by pressing ►► key.

P3.44	Displayed parameter selection 4	Range: 00~15	00
--------------	--	---------------------	-----------

This function is used for LED displayed parameter when inverter stopping. 0-15 relate to monitoring parameter b-01 to b-15. For example, output current will displayed on LED when setting P3.44=03. Users can monitor other parameters by pressing ►► key.

P3.45	Non unit display	Range: 0.1~60.0	1.0
--------------	-------------------------	------------------------	------------

	coefficient		
--	--------------------	--	--

The function is used for proportional relationship of monitoring parameters b-06 and the output frequency

b-06 displayed value=output freq.xP3.45

P3.46	JOG/REV swtiching	Range: 0, 1	0
--------------	--------------------------	--------------------	----------

Select the JOG / REV key switching. Settings are as follows:

- 0: JOG running mode
- 1: REV running mode

6.5 Terminal Control Function Parameter (P4 Group)

P4.00	Input terminal X1 function selection	Range: 0~30	0
P4.01	Input terminal X2 function selection	Range:0~30	0
P4.02	Input terminal X3 function selection	Range: 0~30	0
P4.03	Input terminal X4 function selection	Range: 0~30	0
P4.04	Input terminal X5 function selection	Range: 0~30	0
P4.05	Input terminal X6 function selection	Range: 0~30	0
P4.06	Input terminal X7 function selection	Range: 0~30	0
P4.07	Input terminal X8	Range: 0~30	0

	function selection		
--	---------------------------	--	--

The multifunctional input terminal X1~X8 provide various function. It can set the value of P4.00~P4.07 to define the function of terminal X1~X8 shown as Table 6-1. Terminal X7 -FWD terminal, X8 -REV terminal.

Table 6-1 Multifunctional input selection

content	function	content	Function
0	Idle terminal	19	Freq. control channel selection 1
1	Multi-stage speed terminal 1	20	Freq. control channel selection 2
2	Multi-stage speed terminal 2	21	Freq. control channel selection 3
3	Multi-stage speed terminal 3	22	Command switched to terminal
4	External FWD JOG control input	23	Running command control mode selection 1
5	External REV JOG control input	24	Running command control mode selection 2
6	Acc/Dec time terminal 1	25	Swing freq start mode selection
7	Acc/Dec time terminal 2	26	Swing freq running reset
8	Acc/Dec time terminal 3	27	Close loop invalid
9	3-wire control	28	Simple PLC running pause command
10	Free stop input (FRS)	29	PLC invalid
11	External stop command	30	PLC reset in stopping state
12	Stopping DC brake input command DB	31	Freq. switched to CI
13	Inverter running prohibited	32	Counter trigger signal input
14	Freq. increase command(UP)	33	Counter clear input
15	Freq. decrease	34	External interrupt input

16	Acc/Dec prohibited command	35	Pulse freq. input (only valid for X6)
17	External reset input (clear fault)	36	Fire mode
18	Peripheral equipment fault input (normally open)	37	

Description of function listed in Table 6-1:

1~3: Multi-stage speed control terminal

It can set 7-stage speed running frequency at most by selecting ON/OFF combination of these 3 control terminals and selecting Acc/Dec time at the same time shown as Table 6-2.

Table 6-2 Multi-stage speed running selection

K₃	K₂	K₁	Freq. setting	Acc/Dec time
OFF	OFF	OFF	Normal running freq.	Acc/Dec time 1
OFF	OFF	ON	Multi-stage freq.1	Acc/Dec time 1
OFF	ON	OFF	Multi-stage freq.2	Acc/Dec time 2
OFF	ON	ON	Multi-stage freq.3	Acc/Dec time 3
ON	OFF	OFF	Multi-stage freq.4	Acc/Dec time 4
ON	OFF	ON	Multi-stage freq.5	Acc/Dec time 5
ON	ON	OFF	Multi-stage freq.6	Acc/Dec time 6
ON	ON	ON	Multi-stage freq.7	Acc/Dec time 7

The above multi-stage frequency can be used in multi-stage speed running mode and simple PLC running mode. Herein take multi-stage speed running for example as follow.

Define control terminal X1, X2, X3 as follow.

P4.00=1, P4.01=2, P4.03=3, that X1, X2, X3 are used to achieve multi-stage speed running shown as Fig.6-18.

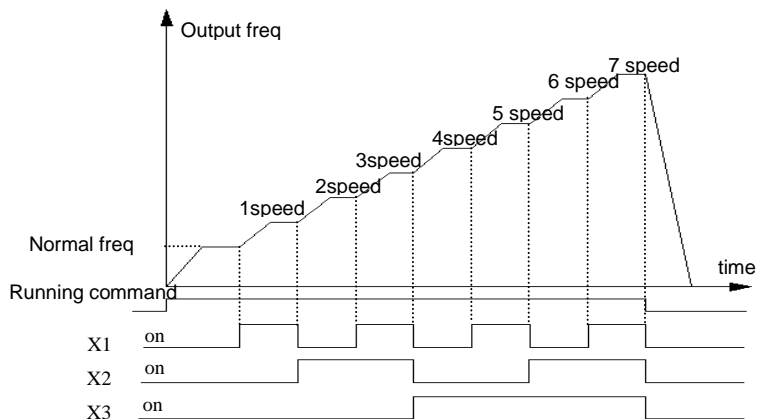

Fig 6-18 multi-stage speed running

Take terminal control mode for example as Fig.6-19, that K7,K8 can control forward or reverse running.

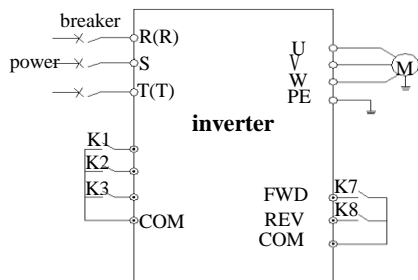

Fig.6 – 19 wiring diagram of multi-stage speed running

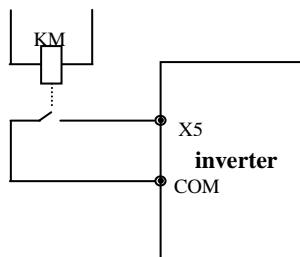

Fig.6-20 peripheral equipment

4-5: External JOG control input JOGP/JOGR.

In terminal control mode(P0.03=1), JOGP is JOG forward running, JOGR is JOG reverse

running. JOG running frequency and JOG running Acc/Dec time is defined by P3.06~P3.08.

6~8: Acc/Dec time terminal selection.

Table 6-3 Acc/Dec time terminal selection logical mode

Terminal 3	Terminal 2	Terminal 1	Acc/Dec time selection
OFF	OFF	OFF	Acc time1/Dec time 1
OFF	OFF	ON	Acc time2/Dec time 2
OFF	ON	OFF	Acc time3/Dec time 3
OFF	ON	ON	Acc time4/Dec time 4
ON	OFF	OFF	Acc time5/Dec time 5
ON	OFF	ON	Acc time6/Dec time 6
ON	ON	OFF	Acc time7/Dec time 7

By ON/OFF combination of Acc/Dec time terminal the Acc/Dec time 1~7 can be selected accordingly.

9: 3-wire control. Please refer to P4.08.

10: Free stop input (FRS). This function is same as free stop defined by P2.05. But this is controlled by terminal which is convenient for remote control.

11: External stop command. This command is effective in all running command control mode.

12: Stopping DC brake input command DB. Use control terminal to execute DC brake to the motor during stop process in order to achieve motor emergency stop and accurate positioning. Brake start frequency, brake current, and brake time are defined by P2.06~P2.08

13: Inverter running prohibited. When this terminal is effective, the inverter in running state will go to stop, and the inverter in stopping state will be prohibited to start. This function is mainly used in application requiring safety linkage.

14~15: Freq. Increasing command (UP), Freq. decrease command (DOWN). The frequency increase or decrease is controlled by control terminal. It can take the place of control panel in remote control mode.

16: Acc/Dec prohibited command. To maintain the motor free from influence of any input command except stopping command, and keep running at the present speed.

Note: Function invalid at normal Dec stop process

17: External reset input(clear fault). When there is a fault alarm, it can reset the inverter by this terminal. This function is same as ENTER/DATA key in control panel

18: Peripheral equipment fault input(normally open). The peripheral equipment fault can be input by this terminal for the convenience of inverter to monitor the peripheral equipment. The inverter will display'E-13', that is peripheral equipment fault alarm, after receiving peripheral equipment fault signal.

19~21: Freq. Control channel selection. The freq. control channel can be switchable by the ON/OFF combination of these 3 control terminals shown as Table 6-4. For this function and P0.01 defined function, the later set one is prior to previous one.

Table 6-4 Freq. control channel selection logical mode

Freq. control channel selection terminal 3	Freq. control channel selection terminal 2	Freq. control channel selection terminal 1	frequency control channel selection
OFF	OFF	OFF	Maintaining set Freq.
OFF	OFF	ON	Function code digital given
OFF	ON	OFF	Terminal UP/DOWN given
OFF	ON	ON	Serial port given
ON	OFF	OFF	VI
ON	OFF	ON	CI
ON	ON	OFF	PULSE
ON	ON	ON	Combination given (refer to P3.01)

22: Command switched to terminal. As this function is effective, the running control mode will be switched to terminal control mode.

23~24: Running control mode selection

The running control mode can be switchable by the ON/OFF combination of these 2 control

terminals shown as Table 6-5. For this function and P0.03 defined function, the later set one is prior to previous one.

Table6-5 running control mode selection logical mode

Running control mode selection 2	Running control mode selection 1	Running control mode selection
OFF	OFF	Maintaining running control mode
OFF	ON	Control panel control mode
ON	OFF	Terminal control mode
ON	ON	Serial port control mode

25: Swing freq. start mode selection.

In swing frequency manual start mode, the swing frequency running will be effective as this terminal is effective (refer to P9 Group).

26: Swing freq. running reset

In swing frequency running mode, no matter it is in manual or automatically start mode, by closing this terminal it will clear the recorded data of swing frequency running. The swing frequency running will restart by disconnecting this terminal. (Referring to P9 Group)

27: Close loop invalid

In close loop running state, this function can invalidate the close loop running, and the inverter will switch to lower priority running mode.

Note: only in the closed-loop operation (P7.00 = 1) it can be switched between the closed-loop and low-level operating mode.

28: Simple PLC running pause command

In simple PLC running state, as this function is effective, the PLC running will pause, and the inverter will run at 0 HZ. As this function is invalid, the inverter will automatically execute running speed tracking start and continue PLC running (refer to P8 Group).

29: PLC invalid

In PLC running state, this function can invalidate the PLC running, and the inverter will switch to lower priority running mode.

30: PLC reset in stopping state

In the stopping state of PLC running mode, as this terminal is effective, the inverter will clear the data recorded in stopping state, such as PLC running stage, running time, and running frequency, etc. (refer to P8 Group).

31: Freq. Switched to CI

When this function is effective, the frequency control channel will be switched to CI given.

32: Counter trigger signal input

There is a built-in counter in inverter, the max input pulse frequency to pulse input port is 200Hz. It can store memory the present counted data when power failure (refer to P4.21, P4.22).

33: Counter clear input.

Clear the built-in counter to 0.

34: External interrupt input

In the running state, when inverter receives external interrupt signal, it will stop output, and run at zero frequency. After the interrupt signal is cancelled, the inverter will execute automatically the running speed tracking start mode, and continue to run again.

35: Pulse freq. input

Only valid for X4 terminal. This terminal receives pulse signal as frequency given command (refer to P1.11~P1.15).

36: Fire mode

Inverters ignore the control signal or alarm in the fire mode. It will be possible to extend the reliable running time until it is damaged to ensure a safe evacuation in a smoke-free environment

P4.08	FWD/Rerunning mode selection	Range: 0~4	0
--------------	-------------------------------------	-------------------	----------

4 control modes:

0: 2-wire control mode 1

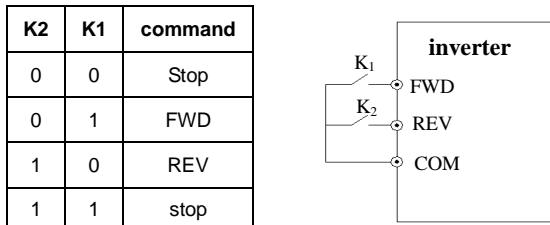
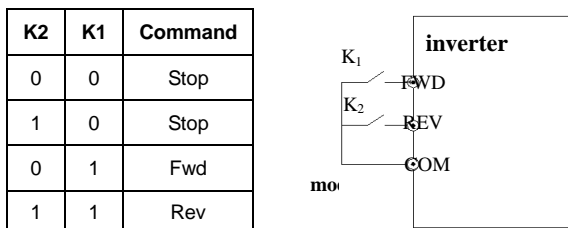

Fig.6-21 2-wire control mode1

1: 2-wire control mode 2



2: 3-wire control mode 1

- SB1: stop
- SB2: FWD
- SB3: REV

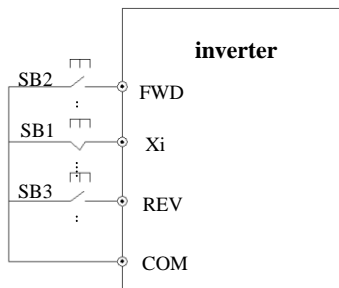

Fig.6-23 2-wire control mode 1

Xi is one of multifunctional input terminal X1~X6 which should be defined to function 9, that is 3-wire control mode.

3: 3-wire control mode 2

SB1: stop

SB2: run

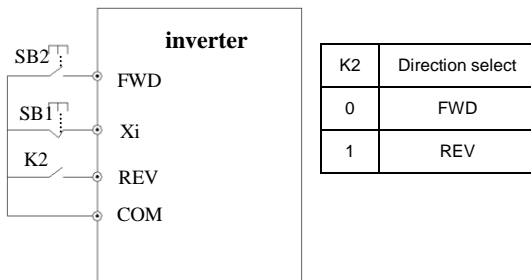

Fig.6-24 3-wire control mode 2

Xi is one of multifunctional input terminal X1~X6 which should be defined to function 9, that is 3-wire control mode.

Note: In alarm stopping mode, if the running control mode is selected as terminal control mode and FWD/REV terminal is effective, the inverter will start at once after fault reset.

P4.09	UP/DOWN rate	Range: 0.01~99.99Hz/s	1.00 Hz/s
--------------	---------------------	------------------------------	------------------

This function code defines the rate of change of set frequency given by UP/DOWN terminal.

P4.10	2-way open collector output terminal OC 1	Range: 0~22	0
P4.11	2-way open collector output terminal OC 2	Range: 0~22	0
P4.12	Relay output selection	Range: 0~22	0

P4.13	Relay output selection	Range: 0~22	0
--------------	-------------------------------	--------------------	----------

OC1 Open collector output terminal. Table 6-6 is for function optional parameters.

Table 6-6 Output terminal function selection

content	function	content	Function
0	Inverter is running(RUN)	11	PLC running cycle finish
1	Freq. arrival signal(FAR)	12	Set counts arrival
2	Freq. level detected signal(FDT1)	13	Specified counts arrival
3	reversed	14	Inverter ready for running (RDY)
4	Overload pre-alarm signal (OL)	15	Inverter fault
5	Under voltage locking (LU)	16	Start freq. running time
6	External faults stopping (EXT)	17	DC brake time when start
7	Output freq. upper limit (FH)	18	DC brake time when stop
8	Output freq. lower limit (FL)	19	Swing freq. upper/lower limit
9	Inverter in 0 speed running	20	Set running time arrival
10	Simple PLC stage running finish	21	Upper pressure alarm signal
22	Lower pressure alarm signal		

The description of function listed in Table 6-6 as follow.

- 0: Inverter in running(RUN). In the running state, it outputs index signal.
- 1: Freq. arrival signal(FAR). Please refer to P4.12.
- 2: Freq. level detected signal(FDT1). Refer to P4.11~P4.12.
- 3: reserved
- 4: Overload pre-alarm signal(OL). As inverter output current exceeds P5.02 defined overload detected level and the time is longer than P5.03 defined overload detected time. It outputs index signal.

- 5: Under voltage locking(LU). In the running state, when DC bus bar voltage is lower than limited level, the inverter will display 'E-11' and outputs index signal.
- 6: External fault stopping(EXT). When external fault alarm occurs (E-13), it outputs index signal.
- 7: Output freq. upper limit(FH). When set freq upper limit freq, and running frequency reaches upper limit freq, it outputs index signal.
- 8: Output freq. lower limit(FL). When setting freq lower limit freq, and running frequency reaches lower limit frequency, it outputs index signal.
- 9: Inverter in zero speed running. When the inverter outputs 0 HZ, but still in running state, it will outputs index signal.
- 10: Simple PLC stage running finish. When present simple PLC stage finishes, it outputs index signal.(single pulse signal, width is 500ms).
- 11: A PLC running cycle finish. When a simple PLC running cycle finishes, it outputs index signal.(single pulse signal, width is 500ms).
- 12: Set counts arrival.
- 13: Specified counts arrival. (Refer to P4.21~P4.22)
- 14: Inverter ready for running(RDY). When this signal outputs, it means the inverter bus bar voltage is normal, and the inverter running prohibited terminal is invalid, that inverter can start.
- 15: Inverter fault. When fault occurs in the running state, it outputs index signal. .
- 16: Start freq. running time .
- 17: DC brake time when start.
- 18: DC brake time when stop.
- 19: Swing freq. upper/lower limit. In swing frequency running mode, if the fluctuation range of swing frequency calculated according to center freq. exceeds upper limit freq.P0.19 or below lower limit freq.P0.20, it outputs index signal.

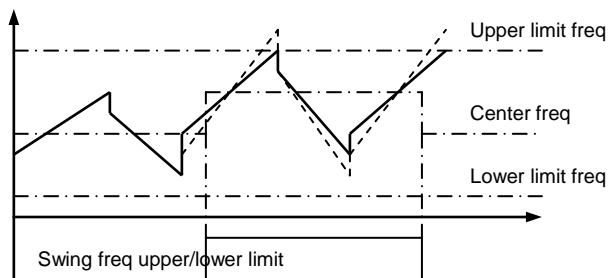

Fig.6-25 swing freq. upper/lower limit

20: Set running time arrival. When inverter total running time (P3.40) reaches set running time (P3.39), it outputs index signal.

21: upper pressure alarm signal. On closed-loop control, Inverter output alarm signal when the pipeline pressure is greater than the upper limit of pressure.

22: Lower pressure alarm signal. On closed-loop control, Inverter output alarm signal when the pipeline pressure is lower than the lower limit of pressure.

P4.14	Freq. arrival detection range(FAR)	Range: 0.00~50.00Hz	5.00Hz
--------------	---	----------------------------	---------------

This function is a complement to function 1 listed in Table 6-6. When inverter output frequency is in the “+ -” detection range of set frequency, it outputs pulse signal shown as Fig.6-25.

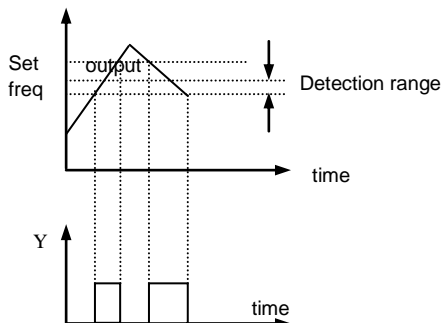

Fig.6-26 Freq. arrival detection range

P4.15	FDT1 (freq. level)	Range: 0.00~upper limit freq.	10.00Hz
P4.16	FDT1 lag	Range: 0.00~50.00Hz	1.00Hz

P4.13~P4.14 are the complement to function 2 listed in Table 6-6.
 P4.15~P4.16 are the complement to function 3 listed in Table 6-6.
 Both are same in usage. For example, when output frequency exceeds a certain set frequency (FDT1), it outputs index signal until output frequency decreasing to a certain frequency lower than FDT1 (FDT1-FDT1 lag) shown as Fig.6-28

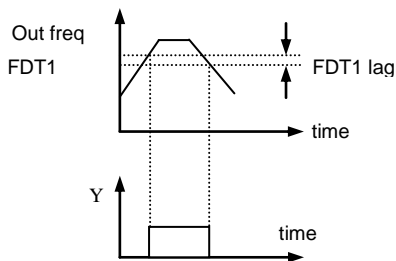

Fig.6-27 freq level detection

P4.17	Analog output(AO1)selection	Range: 0~7	0
P4.18	Analog output(AO1)gain	Range: 0.50~2.00	1.00
P4.19	Analog output (AO2) selection	Range: 0~7	0
P4.20	Analog output (AO2) gain	Range: 0.50~2.00	1.00

6-7 Output terminal indication

content	function	Indication range
0	Output freq.	0~limit freq
1	Output current	0—2×rated current
2	Output voltage	0—1.2×motor rated voltage
3	Bus bar voltage	0—800V
4	PID given	0~10V
5	PID feedback	0~10V
6	VI	0~10V
7	CI	0~10V/4~20mA
Ten's content	function	description
0	0~10V	Output voltage 0~10V
1	0~20mA	Output current 0~20mA, AO1jumper to 1
2	4~20mA	Output current 4~20mA , AO1 jumper to 1

As to AO analog output, if user wants to change measuring range or adjust meter tolerance, it can be achieved by regulating the output gain.

P4.21	DO output terminal function selection	Range: 0~7	0
-------	---------------------------------------	------------	---

Please refer to Table 6-7.

P4.22	DO max pulse output freq	Range: 0.1~20.0 (Max.20K)	10.0K
-------	--------------------------	---------------------------	-------

P4.23	Set counts given	Range: P4.20~9999	0
P4.24	Specified counts given	Range: 0~P4.19	0

P4.21,P4.22 are the complement to function 12,13 listed in Table 6-6.

Set counts given: It refers to when how many pulse signals input from Xi (count trigger signal input function terminal), OC (2-way open collector output terminal) or relay outputs an index signal.

When Xi inputs the 8th pulse signal, OC outputs an index signal, that is P4.21=8, shown as Fig.6-27.

Specified counts given: It refers to when how many pulse signals input from Xi, OC or relay outputs an index signal, until set counts arrival.

When Xi inputs the 5th pulse signal, relay outputs an index signal, until set counts 8 arrival, that is P4.22=5, shown as Fig.6-27. When specified counts bigger than set counts, specified counts invalid.

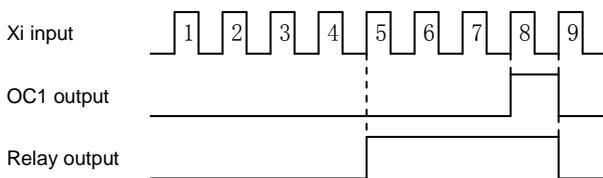

Fig.6—28 set counts given and specified counts given

P4.25	Overload pre-alarm detection level	Range: 20—200(%)	130(%)
P4.26	Overload pre-alarm delay time	Range: 0.0—20.0S	5.0S

If output current exceeds continuously current detection level set by P4.23 (the actual detection level current = P4.23 X inverter rated current), after the delay time set by P4.24, the open collector outputs valid signal shown as Fig. 6-28 (refer to P4.11).

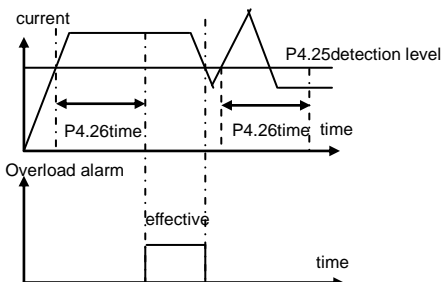

Fig.6—29 overload alarm

6.6 Protection Function Parameter (P5 Group)

P5.00	Motor overload protection mode selection	Range: 0, 1	0
--------------	---	--------------------	----------

This parameter defines the inverter protection mode in the case of overload, over current.

0: Stop outputting: In the case of overload, over current, the inverter will stop outputting at once, and the motor will go to free stopping

1: Inaction: Without overload protection to load motor , please use this function in caution.

P5.01	Motor overload protection coefficient	Range: 20%—120%	100%
--------------	--	------------------------	-------------

This parameter is used for setting sensitivity of thermal relay protection to load motor. When motor output current doesn't match inverter rated current, by setting this parameter it could get correct protection to motor, shown as Fig.6-30.

$$[P5.01] = \frac{\text{Motor rated current}}{\text{Inverter rated output current}} \times 100$$

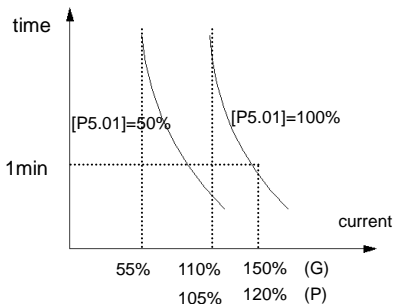

Fig. 6-30 Thermal relay protection

Note: When one inverter drives multi-motor in linkage running, the thermal relay protection will be out of action. Please install thermal relay to each motor input terminal as to protect the motor effectively.

P5.02	Overvoltage stall selection	Range: 0, 1	1
P5.03	Overvoltage stall point	Range: 380V: 120—150(%) 220V: 110~130(%)	140(%) 120(%)

- 0: prohibited
- 1: allowed
- 0: prohibited
- 1: allowed

In inverter Dec running process, because of the affection of load inertia, the actual Dec rate of motor speed may be lower than output frequency Dec rate. At this moment the motor will feed back

electrical energy to inverter which will

cause the bus bar voltage rising. If don't take measures, the overvoltage protection will be triggered

In the inverter Dec running process, the overvoltage stall protection function will detect the

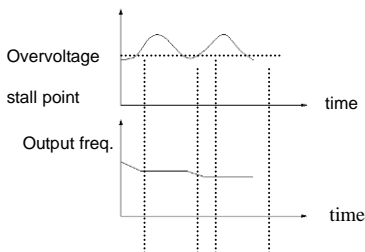

Fig.6-31 overvoltage stall

bus bar voltage and compare it with overvoltage stall point defined by P5.03 (relative to standard bus bar voltage), if it exceeds overvoltage stall point, the inverter will stop decreasing output frequency. After detecting bus bar voltage lower than overvoltage stall point again, the Dec process will restart, shown as Fig.6-30.

P5.04	Auto current limit level	Range: 110~200(%)	150(%)
P5.05	Freq. drop rate current limit	Range: 0.00~99.99Hz / S	10.00Hz/S
P5.06	Auto current limit mode selection	Range: 0、 1	1

Auto current limit function is to auto limit the load current not to exceed auto current limit level (P5.04) by real time monitoring the load current in order to prevent fault trip caused by over current. It is suitable to some applications with bigger inertia or load change in intensity.

Function code P5.04 defines the current threshold value of auto current limit action; the set range is a percentage to inverter rated current. Function code P5.05 defines regulating rate to output frequency during auto current limit action.

If freq. drop rate (P5.05) during current limit is too small to get rid of auto current limit state, it may finally cause load fault. If freq. drop rate is too big to intensify frequency regulating range, it may cause inverter overvoltage protection.

Auto current limit function is always valid during Acc/Dec state. Auto current limit mode selection (P5.06) defines whether auto current limit function is valid in constant speed running state.

P5.06=0 Auto current limit invalid in constant speed running

P5.06=1 Auto current limit valid in constant speed running

Auto current limit function is not suitable to constant speed running requiring stable output frequency, because the output frequency may changes during auto current limit action.

P5.07	Restart setting after power failure	Range: 0, 1	0
P5.08	Restart waiting time after power failure	Range: 0.0~10.0S	0.5S

P5.07 = 0, Restart after momentary power failure inaction

P5.07 = 1, Restart after momentary power failure inaction

If occur momentary power failure (LED displays 'E-11') in inverter running state, when power comes back, the inverter will automatically execute tracking speed restart mode after waiting for time set by P5.08. During the waiting time, even there is a run command inputting, the inverter will not restart. If stopping command is input at that time, the inverter will cancel tracking speed restart.

P5.09	Fault self-recovery times	Range: 0~10	0
P5.10	Self-recovery interval time	Range: 0.5~20.0S	5.0S

During inverter running, fault may occur accidentally and inverter output may stop due to load fluctuation. At the moment, user may use fault self-recovery function in order not to stop running of equipment driven by inverter. In the process of self-recovery, the inverter will execute tracking speed restart mode. If the inverter fails to restart successfully in set times defined by P5.10, it will execute fault protection and stop output.

Note:

(1) This function is used on condition that the inverter has no substantial fault and self-recovery function is allowed by equipment.

(2) This function is invalid to fault protection due to overload or overheat.

P5.11	Input missing phase protection	Range: 0, 1	0
--------------	---------------------------------------	--------------------	----------

0: Inaction

1: Action

Note:

U phase missing protection, displays E-26

V phase missing protection, displays E-27

W phase missing protection, displays E-28

6.7 Fault Record Function Parameter (P6 Group)

P6.00	Last fault record	Range: 0~23	0
--------------	--------------------------	--------------------	----------

P6.07	Last 2 fault record	Range: 0~23	0
P6.08	Last 3 fault record	Range: 0~23	0
P6.09	Last 4 fault record	Range: 0~23	0
P6.10	Last 5 fault record	Range: 0~23	0
P6.11	Last 6 fault record	Range: 0~23	0

0: No fault

1~17: E-01~E-17 fault, refer to Chapter 7.

P6.01	Output freq. in last fault	Range: 0~upper limit freq	0
P6.02	set freq. in last fault	Range: 0~upper limit freq	0
P6.03	Output current in last fault	Range: 0~999.9A	0
P6.04	Output voltage in last fault	Range: 0~999V	0
P6.05	DC bus bar voltage in last fault	Range: 0~800V	0
P6.06	Module temp. in last fault	Range: 0~100	0

6.8 Close Loop Running Control Function parameter (P7-Z Group)

Analog feedback control system:

Input pressure given value by VI and input 4~20mA feedback value of pressure sensor by CI, constitute an analog feedback control system through built-in PI adjuster shown as Fig.6-32

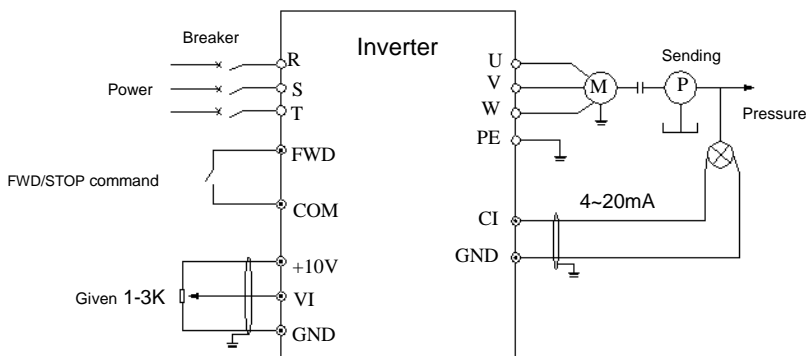

P7.00	Close loop running control selection	Range: 0, 1	0
--------------	---	--------------------	----------

0: Invalid

1: Valid

P7.01	Close loop given channel selection	Range: 0, 1, 2	0
--------------	---	-----------------------	----------

0: Digital given

1: VI analog 0~10V voltage given.

2: CI analog 0~10V voltage given or 4~20mA current given. To speed close loop, analog given 10V corresponding the rotate speed of max output frequency.

P7.02	Feedback channel selection	Range: 0~6	0
--------------	-----------------------------------	-------------------	----------

0: VI analog 0~10V input voltage

1: CI analog 0~10V input voltage

2: VI +CI

3: VI - CI

4: Min {VI, CI}

5: Max {VI, CI}

6: CI analog 4~20mA input voltage. System board JP3 jumper to jump to the "1" side, so as to select 4 ~ 20mA current feedback input.

P7.03	Given channel filtering time constant	Range: 0.01~50.00S	0.50S
P7.04	Feedback channel filtering time constant	Range: 0.01~50.00S	0.50S

External to a given and feedback channels are often superimposed on the interference, by setting the P7.03 and P7.04 filter time constant on the channel filter, filter the longer the anti-interference ability is stronger, but the response is slow. Filter time shorter response more quickly, but the anti-interference ability is weak.

P7.05	Given value digital setting	Rang: 0.001—20.000Mpa	0.00Mpa
--------------	------------------------------------	------------------------------	----------------

As P7.01=0, P7.05 defined value is used as close loop control system given value, that user can change system given value by revising P7.05 when using control panel or serial port to control close loop system

P7.06	Feedback signal characteristics	0: Positive characteristic 1: Negative characteristic	0
--------------	--	--	----------

The parameters used to define the feedback signal and the preset relationship between signal:

0: Positive characteristic: Said feedback signal corresponding to maximum capacity maximum.

1: Negative characteristic: Said feedback signal corresponding to maximum quantity minimum.

P7.07	Feedback channel gain	Range: 0.01~10.00	0
--------------	------------------------------	--------------------------	----------

As the feedback channel and the channel signal level is not consistent, with the parameters of the feedback channel signal gain adjustment.

P7.08	Lower pressure limit	Range: 0.001~P7.09	0.001
P7.09	Upper pressure limit	Range: P7.08~P7.27	1.000

This parameter is used to set upper and lower limit pressure, when the set pressure is greater than the P7.09 value, the maximum set pressure value for P7.09, when the set pressure is less than the value of P7.08, set the minimum pressure for the P7.08 value.

P7.10	PID controller structure	Range: 0, 1, 2, 3	1
--------------	---------------------------------	--------------------------	----------

This parameter is used to select the built-in PID controller structure.

0: Proportional control;

1: Integral control

2: Proportion, integral control;

3: Proportion, integral, differential control

P7.11	Proportional gain(KP)	Range: 0.00~5.00	0.50
P7.12	Integral time constant	Range: 0.1~100.0 sec	10.0
P7.13	Differential gain	Range: 0.0~5.0	0.0

Built-in PID controller parameters setting, should according to the actual demand and system adjustment.

P7.14	Sampling period	Range: 0.01~1.00 sec	0.10
--------------	------------------------	-----------------------------	-------------

Feedback value sampling period.

P7.15	Deviation limit	Range: 0~20(%)	0(%)
--------------	------------------------	-----------------------	-------------

Loop setting point maximum allowable deviation, as shown in figure 6-37. When the amount of feedback keeps in this range, the PI regulator will stop adjustment. This function is reasonable use contribute to the coordination of system output precision and stability of the contradiction between.

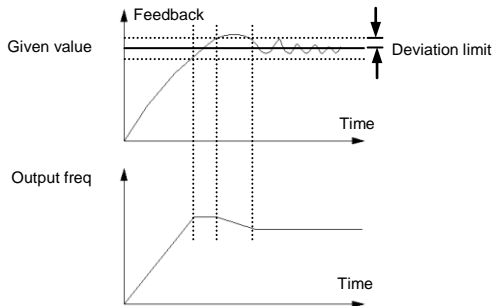

Fig.6-33 Deviation limit

P7.16	PID feedback disconnection detection threshold	Range: 0.0~20.0%	0.0%
P7.17	PID feedback disconnected action selection	Range: 0~3	0

P7.18	PID feedback disconnection action time delay	Range: 0.01~5.00 秒	1.00
--------------	---	---------------------------	-------------

As the PID feedback value below P7.16 set detection threshold, the accumulated delay time P7.18 seconds later, it is judged to feedback disconnected. The action will be defined by the parameter P7.17 selection after feedback offline.

0: Stop

1: According to the P0.02 setting frequency operation

2: According to upper limit frequency operation

3: According to upper limit frequency half running

P7.19	Wake up pressure level.	Range: 0.001~P7.20	0.001
--------------	--------------------------------	---------------------------	--------------

This parameter defines the system from a hibernation state to enter the working state of the pressure limit.

As the pipeline pressure is smaller than the set value, illustrate the tap water pressure to reduce or increase in the water content, frequency conversion water supply system automatically from the dormant state to state.

P7.20	Hibernation pressure level	Range: P7.19~P7.27	1.000
--------------	-----------------------------------	---------------------------	--------------

This parameter defines the system enters a hibernation state stress limit value.

As the pipeline pressure is greater than the set value, and the frequency of water supply systems have been adjusted to the hibernation frequency operation, descriptions of actual water decrease sharply or tap water pressure increases, the frequency of water supply system to automatically enter a state of dormancy, stop wait wake.

As the water supply system to reach the awake and hibernation condition, enter the awakening and hibernation latency by the parameter P7.21 and P7.23 to determine.

P7.21	Hibernation level continuous time	Range: 0~250S	10S
--------------	--	----------------------	------------

The parameter setting in hibernation, pipe network pressure in hibernation pressure level maintained in continuous time.

P7.22	Hibernation frequency	Range: 0.00~400.0HZ	20.00HZ
--------------	------------------------------	----------------------------	----------------

The parameter is setting the minimum operating enter into hibernation state.

P7.23	Hibernation frequency continuous time	Range: 0~250S	10S
--------------	--	----------------------	------------

The parameter is setting inverter running time, when reach the hibernation frequency,.

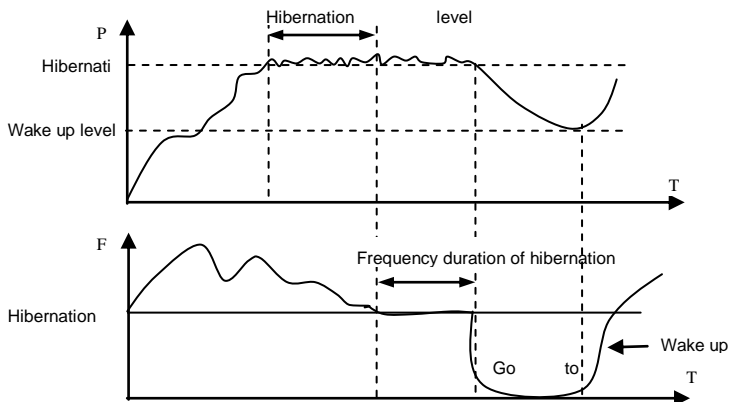

Fig.6-34 Hibernation wake

P7.24	Alarm low limit pressure	Range: 0.001~P7.25	0.001
P7.25	Alarm up limit pressure	Range: P7.24~P7.27	1.000

As the pressure of a pipe network under lower pressure, and the inverter frequency reaches the set upper limit frequency of or all the pump frequency operation, indicates that the pipeline under pressure, frequency converter can output alarm signal. P4.10 or P4.11 is set to 21, then the maximum pressure alarm

As the pipeline pressure is greater than the upper limit of pressure, and the inverter frequency reaches the set lower limit of frequency, indicates that the pipeline pressure, frequency converter can output alarm signal. This function can be used to determine the pipeline blocking. P4.10 or P4.11 is set to 22, is the output of lower pressure alarm

P7.26	Constant pressure water supply mode	Range: 0 — 4	0
--------------	--	---------------------	----------

0: No constant pressure water supply mode.

1: One pump water supply mode (Selection of the constant pressure water supply board)。

2: Two pumps water supply mode (Selection of the constant pressure water supply board)。

3: Three pumps water supply mode (Selection of the constant pressure water supply board)。

4: Four pumps water supply mode (Selection of the constant pressure water supply board) 。

P7.27	Remote pressure gauge range	Range: 0.001—20.00Mpa	1.000
--------------	------------------------------------	------------------------------	--------------

This parameter setting is equal to actual use of gauge range, corresponding to 10V or 20mA.

P7.28	Multi pump operation mode	Range: 0 , 1	0
P7.29	Pump shift in timed intervals	Range: 0.5—100.0h	5.0

Multi pump operation mode for each pump capacity the same system。

0: Fixed sequence shift: According to the detected pressure changes at a fixed shifting sequence plus or minus pump. General pump start from 0

1: Timing of the Shift: This way is actually at a certain time after redefine each pump number, to ensure that each pump can get equal chance and time to run, in order to prevent the pump break for a long time no using. Timing of operation time by P7.29 parameter defined.

P7.30	Pump shifting judgment time	Range: 0.1 — 1000.0 second	300.0S
--------------	------------------------------------	-----------------------------------	---------------

This parameter is used to set the judgment of stability time, when increase or deduce the pump Nos. The setting of parameters too short will cause the system pressure shocks, but the pressure response more quickly.

P7.31	Electromagnetic switching delay time	Range: 0.1 — 10.0 second	0.5S
--------------	---	---------------------------------	-------------

The parameters used to define system delay time of electromagnetic switch, when the switching from Grid frequency to Variable frequency or Variable frequency to Grid frequency.. In order to prevent the circuit shorten between the inverter output terminal and power supply caused by electromagnetic switch delay.

P7.32	PID control of positive and negative role and feedback pressure error polarity	Range: 00—11	00
P7.33	Feedback error of pressure adjustment value	Range: 0.001—20.00Mpa	0.000Mpa

Unit:

0: PID control function.

1: PID control reaction.

Ten:

0: Feedback pressure less than the actual pressure

1: Feedback pressure is greater than the actual pressure

As the PID is stable, found the set pressure and actual pipeline pressure deviation, can be adjusted by P7.32 and P7.33 to eliminate the error, when the actual pipeline pressure is greater than set pressure, P7.3 ten bit set to " 1 ", and the P7.33= actual pressure setting pressure, when the actual pipeline pressure is greater than set pressure, P7.33 ten bit set to " 0 ", and the P7.33= set pressure - the actual pressure.

P7.34	Closed loop of preset frequency	Range: 0—Upper limit frequency	0.00Hz
P7.35	Closed loop of preset frequency holding time	Range: 0.0—100.0S	0.0S

The function code can make the closed-loop regulation quickly into the stable stage. Inverter will accelerate to closed loop of preset point P7.34 and running at the frequency for a period of time. After that time, inverter will run as closed loop operation.

6.9 PLC Running Parameter (P8 Group)

Simple PLC function is a multi-stage speed generator. The inverter can auto change frequency and running direction in set running time to satisfy the techniques command shown as Fig.6-39.

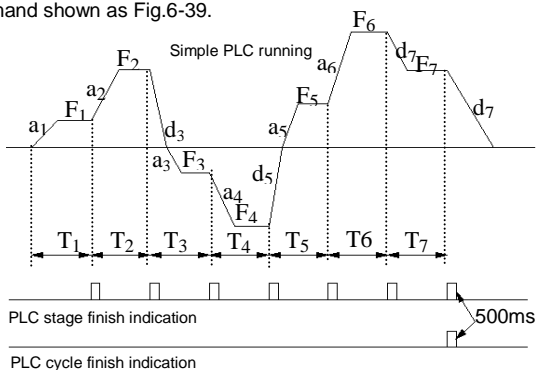

Fig.6-39 simple PLC running

a_1 ~ a_7 , d_1 ~ d_7 are Acc and Dec time in each stage shown as Fig.6-39, which are defined by Acc/Dec time parameter P0.17,P0.18 and P3.14~P3.25.

F_1 ~ F_7 , T_1 ~ T_7 are running frequency and running time which are defined by function code P8.01~P8.14.

P8.00	PLC running mode selection	Range: LED unit: 0~3; ten: 0,1; hundred: 0,1; thousand:0,1	0000
--------------	-----------------------------------	---	-------------

LED unit's digit: PLC running mode selection

0: 0:Inaction

1:Stop after single cycle

The inverter will stop automatically after one cycle. It will restart after receiving a new running command shown as Fig.6-40.

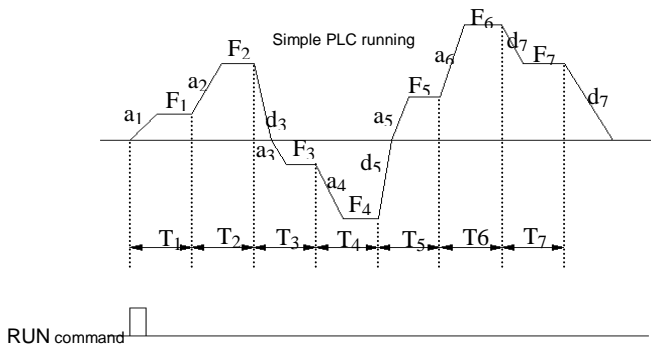

Fig.6-40 PLC stop after single cycle

2: Running at final frequency after single cycle:

The inverter will keep running at the frequency and direction of final stage after one cycle. It will stop in set dec time after receiving stopping command shown as Fig.6-41

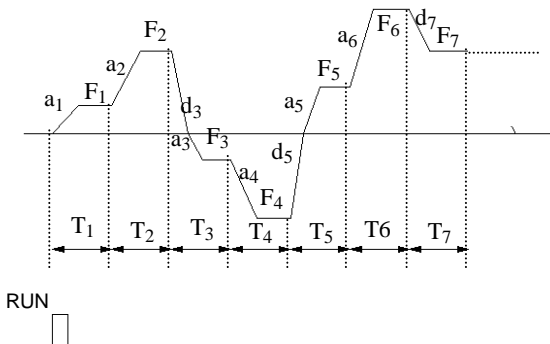

Fig.6-41 PLC running at final frequency after single

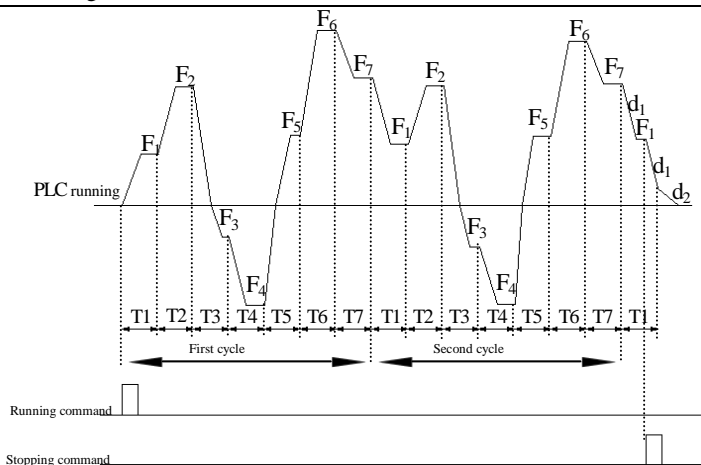

Fig.6-42 PLC continuous cycle

3: Continuous cycle

The inverter automatically starts a new cycle after one cycle finish until receiving stopping command shown as Fig.6-43.

LED ten's digit: PLC restart mode selection

0: Restart from the first stage after stop caused by stopping command, fault or power failure.

1: Restart from the freq. of break stage. After stop caused by stopping command or fault, the inverter will record the running time completed of starts from break stage and runs at set freq. of break stage in rest time of break stage shown as Fig.6-43.

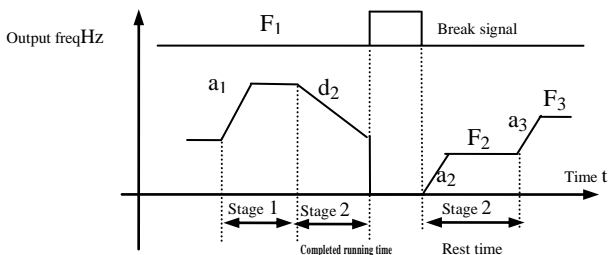

a1: Acc time of stage 1 a2: Acc time of stage 2 a3: Acc time of stage 3

d2: Dec time

Fig.6-43 PLC restart mode 1

3: freq of stage 3

LED hundred's digit: PLC state parameter save mode selection

0: No save. Inverter don't save PLC running state after power failure and restart from the first stage.

1: Save. Inverter saves PLC running state after power failure, including running frequency and running time of break stage.

LED thousand's digit: PLC running time unit

0: Second

1: Minute

The unit only run on PLC stage time definition Validly, PLC operation during deceleration time unit selection is determined by P0.16.

Note:

- (1) PLC for a certain period of time setting 0, means the stage is invalid.
- (2) Through the terminal, PLC process can be suspended, failure, operation control, refer to group P4 terminal related functional parameter group.

P8.01	Stage 1 setting	Range: 000—621	000
P8.02	Stage 1 running time	Range: 0.1—6000.0	10.0
P8.03	Stage 2 setting	Range: 000—621	000
P8.04	Stage 2 running time	Range: 0.1—6000.0	10.0
P8.05	Stage 3 setting	Range: 000—621	000

P8.06	Stage 3 running time	Range: 0.1—6000.0	10.0
P8.07	Stage 4 setting	Range: 000—621	000
P8.08	Stage 4 running time	Range: 0.1—6000.0	10.0
P8.09	Stage 5 setting	Range: 000—621	000
P8.10	Stage 5 running time	Range: 0.1—6000.0	10.0
P8.11	Stage 6 setting	Range: 000—621	000
P8.12	Stage 6 running time	Range: 0.1—6000.0	10.0
P8.13	Stage 7 setting	Range: 000—621	000
P8.14	Stage 7 running time	Range: 0.1—6000.0	10.0

Function code P8.01–P8.14 are used to define PLC running frequency, direction, and Acc/Dec time by LED unit's, ten's, hundred's digit as follow.

LED unit's digit: frequency setting

0: Multi-stage frequency i ($i=1\sim7$) defined by P3.26-P3.32

1: Freq. defined by P0.01 function code

LED ten's digit: running direction selection

0: Forward

1: Reverse

2: Controlled by running command.

LED hundred's digit: Acc/Dec time selection

0: Acc/Dec time 1

1: Acc/Dec time 2

2: Acc/Dec time 3

3: Acc/Dec time 4

4: Acc/Dec time 5

5: Acc/Dec time 6

6: Acc/Dec time 7

6.10 Swing Frequency Function Parameter (PP99 Group)

Swing frequency running is used in textile, chemical fiber industry, etc., and in application which needs traverse drive and winding. The typical application is shown as Fig.6-45.

The swing frequency process is normally as follow:

Firstly it accelerates to preset swing freq (P9.02) in set Acc time and waiting for a while(P9.03), then after goes to swing centre frequency in set Acc/Dec time , finally it enters into swing freq cycle running in set swing amplitude(P9.04),

Kick freq (P9.05), swing freq cycle (P9.06) and delta wave ascent time (P9.07) until receiving stop command to stop in set Dec time.

The swing centre frequency comes from set frequency of normal running, multistage speed running or PLC running.

The swing freq running will be invalid automatically as JOG running or close loop running mode starts.

When PLC running with swing freq, swing frequency will be invalid during switching of PLC stage. It will go to PLC set frequency according to PLC Acc/Dec setting, then swing frequency restarts.

When stopping command is received, it will decelerate to stop in PLC Dec time.

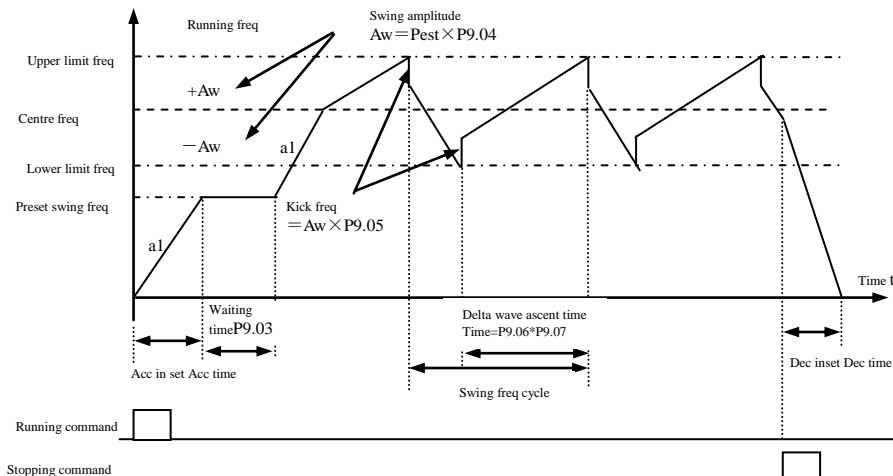

Fig.6-44 Swing frequency running

P9.00	Swing freq selection	Range: 0, 1	0
--------------	-----------------------------	--------------------	----------

0: Inaction 1: Action

P9.01	Swing freq running mode	Range: 0000~1111	0
--------------	--------------------------------	-------------------------	----------

LED unit's digit: start mode

0: Auto start. It keeps running at preset swing frequency(P9.02) for a while(P9.03) after start, then after automatically enters into swing frequency running state.

Function 25 of

1: Manual start by terminal. When multifunctional terminal is valid (Xi),it enters into swing frequency running state. When terminal is invalid, it quits from swing frequency running and keeps running at preset swing frequency(P9.02).

LED ten's digit: swing amplitude control

0: Variable swing amplitude. Swing amplitude AW changes according to centre freq, refer to P9.04.

1: Fixed swing amplitude. Swing amplitude AW is defined by max frequency and function

code P9.04

P9.02	Preset swing freq.	Range: 0.00—650.00Hz	0.00Hz
P9.03	Preset swing freq. waiting time	Range: 0.0—6000.0s	0.0s

P9.02 is used for defining the running freq before swing freq running state. When auto start mode is selected, P9.03 is used for defining the duration of running at preset swing frequency.

When manual start mode is selected, P9.03 is invalid. Refer to Fig.6-44

P9.04	Swing amplitude	Range: 0.0~50.0%	0.0%
--------------	------------------------	-------------------------	-------------

Variable swing amplitude: $AW = \text{centre freq} \times P9.04$

Fixed swing amplitude: $AW = \text{max running freq } P0.06 \times P9.04$

Note: Swing freq is restricted by upper/lower limit frequency.

P9.05	Kick freq.	Range: 0.0~50.0%	0.0%
--------------	-------------------	-------------------------	-------------

P9.05=0, there is no kick freq.

P9.06	Swing freq. cycle	Range: 0.1~999.9s	10.0s
--------------	--------------------------	--------------------------	--------------

This function code is to define the time of a completed cycle of swing freq running.

P9.07	delta wave ascent time	Range: 0.0~98.0%	50.0%
--------------	-------------------------------	-------------------------	--------------

Swing freq ascent stage running time= $P9.06 \times P9.07$ (second),

Descent stage running time= $P9.06 \times (1 - P9.07)$ (second).

Note: User can select S curve Acc/Dec mode at the same time when swing frequency running is selected. It can make swing freq running smooth.

P9.08	Terminal UP/DOWN and Fan control selection	Range: 000~111	0
--------------	---	-----------------------	----------

Unite digit:

0: Inverter fan operation, shutdown after 1 minutes after the fan stops running.

1: Power on the fan operation

Ten digit:

0: When Frequency is set by Terminal UP/DOWN (P0 .01=3), inverter will save the frequency value after power off. When inverter restarts, the initial frequency will be the last saving frequency.

1: When Frequency is set by Terminal UP/DOWN (P0 .01=3), inverter will not save the frequency value after power off. The Intial frequency setting is 0HZ

Hundred digit:

0: Inverter run/ stop is set by Terminal (P0.03=1). After power cut off and switch on, inverter will run or stop according to Terminal setting.

1: Inverter run/ stop is set by Terminal (P0.03=1). After power cut off and switch on, inverter will stop.

P9.09	Multi-function terminal filtering time	Range: 0~4	1
--------------	---	-------------------	----------

The parameter is used for multi-function terminals (X1-X8) signal filtering. Increasing the value, the effect of filtering will be improved, but the Terminal response time will be longer. Reducing the value, the effect of filtering will get worse and Terminal response time is short. In some motion control application which requires instant action, parameter P9.09 should set 0

P9.10	Energy consumption braking unit use rate	Range: 0~100.0%	50.0%
--------------	---	------------------------	--------------

This parameter is used to set the energy consumption braking unit switching value. When the bus voltage in excess of P9.11 (energy consumption braking bus bar voltage), braking unit will start the brake unit according to the percentage of P9.10. The high percentage setting, the braking effect is obvious and the braking current will be high. Users have to set the appropriate adjustment of P9.10 parameters and select the braking resistor.

P9.11	Over voltage threshold value	Range: 0~780V	660V
P9.12	Energy consumption braking bus bar voltage	Range: 0~780V	660V

This parameter is used to set the energy consumption braking start bus voltage. Three-phase 380V inverter power brake boot bus voltage is 660V, single-phase 220V inverter power brake boot bus voltage is 358V,

P9.13	G, P type set	Range: 0, 1	0
--------------	----------------------	--------------------	----------

0: Set to G model, is applied to constant torque load.

1: Set to P model, suitable for fan and pump.

P9.14	User password	Range: 0000~9999	0000
--------------	----------------------	-------------------------	-------------

This function is used for prohibiting non-authorized personnel to view and amend the function parameter. When P9.14=0000, this function is invalid. When this function is needed, please enter 4 digits as password, then after press ENTER/DATA key to confirm it, the password will be Valid immediately. Amend password: press MENU/ESC key to enter into password verification state. After original 4 digits password is entered correctly, it goes to parameter edit state. Select function code P9.14 (P9.14=0000 now), enter a new password, and press ENTER/DATA key to confirm it, the new password will be Valid immediately. The super user password is 2644.

6.11 Vector Control Parameter (PA Group)

PA.00	Motor parameter Auto tuning function	Range: 0, 1	0
--------------	---	--------------------	----------

0: Inaction

1: Static auto-tuning

When settings PA.00=1, inverter show "FUN0 ", then press " FWD " key to start inverter parameter auto-tuning. When keyboard display " FUN1 ", auto tuning is complete.

PA.01	Motor rated voltage	Range: 0~400V	Depends on model type
PA.02	Motor rated current	Range: 0.01~500.00A	Depends on model type
PA.03	Motor rated frequency	Range: 1~500Hz	Depends on model type
PA.04	Motor rated rotating speed	Range: 1~9999 r/min	Depends on model type
PA.05	Motor poles number	Range: 2~16	Depends on model type
PA.06	Motor stator inductance	Range: 0.1~5000.0mH	Depends on model type
PA.07	Motor rotor inductance	Range: 0.1~5000.0mH	Depends on model type
PA.08	Motor stator and rotor mutual inductance	Range: 0.1~5000.0mH	Depends on model type
PA.09	Motor stator resistance	Range: 0.001~50.000Ω	Depends on model type
PA.10	Motor rotor resistance	Range: 0.001~50.000Ω	Depends on

			model type
--	--	--	------------

PA.01~PA.10 are defined as motor parameter. The inverter has its own factory default set parameter which depends on model type. User is able to reset above parameter according to parameter of motor used. These parameter should be entered correctly, otherwise, the vector control function can't achieve desired control effect

PA.11	Over current protection coefficient of torque current	Range: 0~15	15
--------------	--	--------------------	-----------

In vector control mode, this function is used for controlling torque current as to prevent over current .The range of 0-15 correspond to 50%-200%.

PA.12	Proportion adjustment coefficient of speed deviation	Range: 50~120	85
PA.13	Integral adjustment coefficient of speed deviation	Range: 100~500	360

In vector control mode, PA.12~PA.13 are used for controlling motor rotating speed. It can achieve better motor speed control effect by proper adjustment of these two function parameter

PA.14	Vector torque boost	Range: 100~150	100
--------------	----------------------------	-----------------------	------------

In vector control mode, this function is used to boost output torque of motor. It can properly increase this parameter in application with heavy load as to boost output torque of motor.

6.12 Factory Function parameter: (PF Group)

PF.00	Factory function	Range: 0000—9999	0000
--------------	-------------------------	-------------------------	-------------

Factory function, user no need to amend it

Chapter 7 Troubleshooting

7.1 Fault Alarm and Troubleshooting





When the inverter is abnormal, protection function acts: LED displays fault code and the content, fault relay acts, the inverter stops output and the motor coasts to stop. DGI300 series inverter's fault contents and troubleshooting is shown in Table 7-1. After fault alarm occurs, fault phenomenon should be recorded in detail, the fault should be processed according to Table 7-1. When in need of technical assistance, please contact your supplier.

Table 7-1 Alarms and troubleshooting

Fault code	Type of faults	Possible fault reasons	Troubleshooting
E-01	Acc over current	Acc time is too short	Adjust acc time
		V/F curve setup is not suitable	Adjust V/F curve
		Restart the motor in running	Setup start mode as speed tracking
		Torque boost setup is too big	Adjust torque boost or set as auto
		Inverter capacity is too low	Select inverter with proper capacity
E-02	Dec over current	Dec time is too short	Adjust Dec time
		Potential load or load inertia is too	Add suitable braking device
		Inverter capacity is too low	Select inverter with proper capacity
E-03	Over current at constant speed running	Load mutation	Check load
		Acc or Dec time is too short	Adjust Acc or Dec time
		Input voltage abnormal	Check input power supply
		Load abnormal	check load
		Inverter capacity is too low	Select inverter with proper capacity

E-04	Acc overvoltage	Input voltage abnormal	Check input power supply
		Acc time is too short	Adjust Acc time
		Restart the motor in running	Setup start mode as speed tracking
Fault code	Type of faults	Possible fault reasons	Troubleshooting
E-05	Dec overvoltage	Dec time is too short	Adjust the Dec time
		Potential load or load inertia is too	Add suitable braking device
E-06	Overvoltage at constant speed running	Input voltage abnormal	Check input power supply
		Acc or Dec time is too short	Adjust the Acc or Dec time
		Abnormal change of input voltage	Mount input reactor
		Load inertia is too big	Add suitable braking device
E-07	Overvoltage of control power supply	Input voltage abnormal	Check input power supply
E-08	Inverter overheat	Air duct obstruction	Clean air duct
		Environment temperature is too high	Improve the ventilation or decrease the carrier frequency
		Fan damaged	Replace a new fan
		Inverter module abnormal	Contact supplier
E-09	Inverter overload	Acc time is too short	Adjust Acc time
		DC braking value is too high	Decrease DC braking current and increase braking time
		V/F curve setup is not suitable	Adjust V/F curve
		Restart the motor in running	Setup start mode as speed tracking restart
		Mains voltage is too low	Check mains voltage
		Too heavy load	Select inverter with proper capacity

E-10	Motor overload	V/F curve setup is not suitable	Adjust V/F curve
		Mains voltage is too low	Check mains voltage
		General motor runs at low speed with heavy load for long	Use a special motor for long term running
		Wrong setting of motor overload protection factor	Set the factor right
		Motor chocked or sudden change of load	Check load
E-11	Under voltage in running	Mains voltage is too low	Check mains voltage
Fault code	Type of faults	Possible fault reasons	Troubleshooting
E-12	Inverter module protection	Inverter over current	Refer to over current troubleshooting
		Output 3-phase fault or ground short	Re-wiring
		Air duct obstruction or fan damaged	Clean air duct or replace a new fan
		Environment temperature too high	Decrease environment temperature
		Control board connecting wire or plug-in unit loose	Check and re-wiring
		Current waveform abnormal due to output missing phase, etc.	Check wiring
		Auxiliary power damaged, or driving voltage under voltage	Contact supplier

		Control board abnormality	Contact supplier
E-13	Peripheral fault	Close external fault terminals	Check the reason
E-14	Current detecting circuit fault	Loose wiring or terminal connections	Check and re-wiring
		Auxiliary power source damaged	Contact supplier
		Hall component damaged	Contact supplier
		Abnormal amplifier circuit	Contact supplier
E-15	RS232/485 Communication fault	Wrong baud rate setting	Set baud rate properly
		Serial port communication fault	Press  Key to reset or contact supplier
		Improper fault alarm parameter setting	Revise function code P3.09~P3.12
		Upper computer doesn't work	Check upper computer and connecting cable
E-16	System interference	Serious interference	Press  key to reset or install input power source filter
		DSP read/write error	Reset or contact supplier
E-17	EP ^{2P} PROM error	Read/write error of control parameter	press  key to reset or install input power source filter
E-18	Motor parameter over current fault	Power range of Motor and inverter do not match	Contact supplier press  key to reset
E-19	Input phase loss protection	One of R, S, T port has no voltage	Press  key to reset check voltage of R, S, T

E-20	over current fault when restart	Over current when inverter restart and check speed	press  key to reset adjust relevant parameters
------	---------------------------------	--	---

7.2 Fault Record Search

This series inverter record the fault codes occurred in the last 6times and inverter running parameter when last fault occurred. The fault information is saved in P6 group.

7.3 Fault Reset

When fault occurred, please select the following methods to recover:

- (1) When fault code is displayed, after ensure it can be reset, press  key to reset.
- (2) Set any one of X1~X8 terminal as external RESET input (P4.00~P4.07=17).
- (3) Cut off power.



Attention

- (1) Reset the inverter after thoroughly investigating the cause of fault and clearing, otherwise, the inverter may be damaged.
- (2) If it can't be reseted or fault occurs again after reset, please check the cause of fault, continuous reset may damage inverter.
- (3) Reset the inverter after waiting for 5min when overload or overheat protection occurs.

Chapter 8 Preservation and Maintenance

8.1 Preservation and Maintenance

Potential hazards exist due to aging, wear and tear of inverter internal components as well as environmental influences to the inverter, such as temperature, humidity particles etc.. Therefore, daily inspection, periodic preservation and maintenance must be performed to the inverter and its driving mechanism during their storage and operation.

Daily Maintenance

The following must be verified before starting up:

- (1) No abnormal vibration and no abnormal noise.
- (2) No abnormal heat.
- (3) No abnormal ambient temperature.
- (4) The ammeter satisfy the specification
- (5) Fan is working in good condition

8.2 Periodic Preservation and Maintenance

8.2.1 Periodic Maintenance

Cut off the power when inverter is maintained thermally, check after the main circuit power indicator light is off. The checking content is shown in Table 8-1.

table 8-1 Periodic inspections

Checking item	Checking content	Troubleshooting
Screws of control terminals and main circuit terminals	The screws are loose or not	If loose, tighten them with screw driver
heat sink	Whether there is dust	Clean thoroughly the dust ^P
Printed circuit board	Whether there is dust	Clean thoroughly the dust
Cooling fans	Whether there is abnormal vibration or abnormal noise	Replace cooling fans
Power element	Whether there is dust	Clean thoroughly the dust

Electrolytic capacitor	Whether there is discoloring, peculiar smell	Replace electrolytic capacitor
------------------------	--	--------------------------------

8.2.2 Thermally maintaining

In order to let inverter work well for a long term, user must maintain the inverter thermally. The replace time of element of inverter is shown in Table 8-2.

Table 8-2 frequency inverter parts replacement

Items	Time criterion
Cooling fans	2-3 years
Electrolytic capacitors	4-5 years
Printed circuit board	5-8 years
Fuse	10 years

The working condition of the inverter as following:

- (1) Environment temperature: average 30C.
- (2) Load coefficient: under 80%.
- (3) Running time: under 12 hour everyday.

8.3 Warranty of Inverter

Our company supply warranty in the following condition:

- (1) Only inverter in the warranty range.
- (2) In the normal using, inverter damaged in 15 month. Over 15 month, our company will charge for the repair service.
- (3) In the following condition in 15 month, our company also will charge for the repair service:
 - Inverter is damaged caused by user not complying with instructions.
 - Inverter is damaged caused by fire, flood, and abnormal voltage.
 - Inverter is damaged caused by wrong wiring.
 - Inverter is damaged when it is used in the abnormal applications.
- (4) Service charge will be calculated with reference to actual cost, but if included in the contract, then according to the contract.

Chapter 9 Serial port RS485 communication protocol

9.1 Communication overview

Our series of inverters provide users with a common industrial control RS485 communication interface, in which The MODBUS standard protocol is used for communication. The inverters can be used as slave connected to the host (such as PLC controller, PC), both of which have the same communication interface and protocol, for the purpose of centralized monitoring of the inverters. Or one inverter can be used as host and other inverters as slaves, all connected with RS485 communication interface, to achieve multi-machine interaction of the inverters. And with this communication interface, a Keyboard can also be connected to inverters for remote operation.

The MODBUS communication protocol of the inverter supports two transmitting ways: RTU mode and ASCII, and either can be choose. The following is a detailed description of the communication protocol of the inverter.

9.2 Communication protocol specification

9.2.1 Communications networking methods

1. networking methods with inverter as slave:

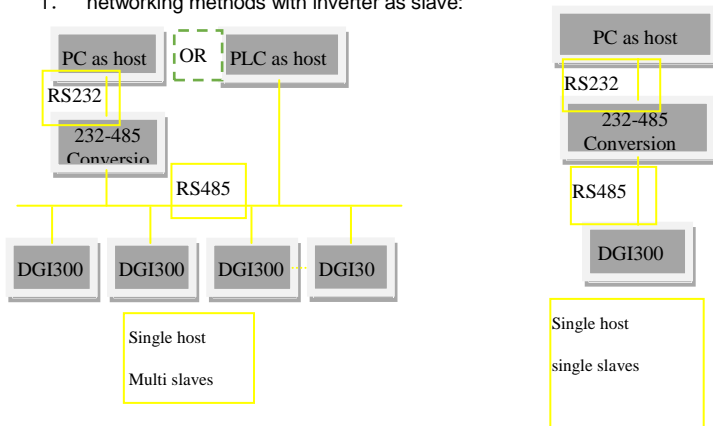
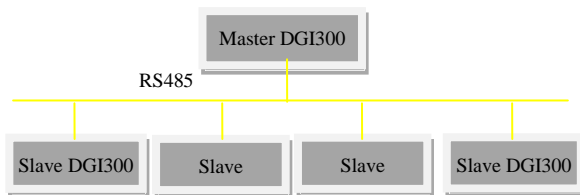

Fig. 9—1 networking of slaves

(2) The networking of multi-machine interaction:

**Fig. The networking of multi-machine interaction**

9.2.2 Communication protocol

The inverter can either be used as a master or slave in RS485 network. It can be used for controlling other inverters as host to achieve multi-level linkage, or controlled by host (PC or PLC) as a slave. The specific communication mode is as follows:

- 1) Inverter is used as slave, in point-to-point communication of master-slave mode. Host sends commands from broadcast address, while slave doesn't answer.
- 2) Inverter is used as host, sending commands from broadcast address, while slave doesn't answer.
- 3) The address, baud rate and data format of the inverter can be setup by using the keyboard or the serial communication.
- 4) message of error is reported by slave, in the recent response frame against host polling

9.2.3 Communication Interface

The communication is using RS485 interface, with asynchronous serial and half-duplex transmission. The default communication protocol is in ASCII mode.

The default data format: 1 start bit, 7 data bits, 2 stop bits.

The default rate is 9600bps. Communication parameter settings reference P3.09 ~ P3.12 function code.

9.3 ASCII protocol

Character structure:

10 characters box (For ASCII)

(1-7-2 format, no parity)

Start bit	1	2	3	4	5	6	7	Stop bit	Stop bit
-----------	---	---	---	---	---	---	---	----------	----------

(1-7-1 format, odd parity)

Start bit	1	2	3	4	5	6	7	Parity bit	Stop bit
-----------	---	---	---	---	---	---	---	------------	----------

(1-7-1 format, even parity)

Start bit	1	2	3	4	5	6	7	Parity bit	Stop bit
-----------	---	---	---	---	---	---	---	------------	----------

11 characters box (For RTU)

(1-8-2 format, no parity)

Start bit	1	2	3	4	5	6	7	Stop bit	Stop bit
-----------	---	---	---	---	---	---	---	----------	----------

(1-8-1 format, odd parity)

Start bit	1	2	3	4	5	6	7	Odd parity	Stop bit
-----------	---	---	---	---	---	---	---	------------	----------

(1-8-1 format, even parity)

Start bit	1	2	3	4	5	6	7	Even parity	Stop bit
-----------	---	---	---	---	---	---	---	-------------	----------

Communications data structures

ASCII mode

Frame header	Start character=": " (3AH)
Address Hi	Address: 8-bit address combined with two ASCII code
Address Lo	
Function Hi	Function code: 8-bit address combined with two ASCII code
Function Lo	
DATA (n - 1)	Data content: n * 8-bit data content combined with 2 * n ASCII code, in which high in front and low in post, n <= 4, 8 ASCII code as maximum
.....	
DATA 0	
LRC CHK Hi	LRC Check code: 8 check code combined with two ASCII code
LRC CHK Lo	
END Hi	End character: END Hi = CR(0DH), END Lo = CR(0AH)
END Lo	

RTU mode:

START	Maintaining no input signal for more than or equal to 10ms
Address	address: 8-bit Binary address
Function	Function code: 8-bit Binary address
DATA (n - 1)	Data content: N*8-bit data, N<=8, less than 8 bytes
.....	
DATA 0	
CRC CHK Low	CRC Check code
CRC CHK High	16-bit CRC check code is combined with 2 8-bit Binary code
END	Maintaining no input signal for more than or equal to 10ms

Address:

00H: All broadcast from inverters

01H: Communication with inverter of 01 address

0FH: Communication with inverter of 15 address

10H: Communication with inverter of 15 address, and so on, maximum to 254 (FEH)。

Function and DATA code:

03H: Read data from a register

06H: Write data to the register.

08H: Loop detection.

Function code 03H: Read data from a register:

For example: read data from the address 2104H of register (Output current)

ASCII mode:

Asking for information string format		Answering information string format	
Header	“:”----3AH	Header	“:”----3AH
Address	“0”----30H	Address	“0”----30H
	“1”----31H		“1”----31H
Function code	“0”----30H	Function code	“0”----30H
	“3”----33H		“3”----33H
content	“2”----32H	Information number	“0”----30H
	“1”----31H		“2”----32H
	“0”----30H		
	“4”----34H	Content of address 2104H	“0”----30H
			“0”----30H
			“0”----30H
			“0”----30H

LRC CHECK	"D" ----44H	LRC CHECK	"D" ----44H
	"7" ----37H		"7" ----37H
END	CR ----0DH	END	CR ----0DH
	LF ----0AH		LF ----0AH

RTU mode:

Asking for information string format		Answering information string format	
Address	01H	address	01H
Function code	03H	Function code	03H
content	21H	Information number	02H
	04H	content	00H 00H
CRC CHECK Low	E8H	CRC CHECK Low	0EH
CRC CHECK High	4BH	CRC CHECK High	37H

Function code 06H: Write to register

For example: writing function code P0.02=50.00HZ to inverter address 01H.

ASCII mode:

Asking for information string format		Answering information string format	
Header	": "----3AH	Header	": "----3AH
Address	"0"----30H	Address	"0"----30H
	"1"----31H		"1"----31H
Function code	"0"----30H	Function code	"0"----30H
	"6"----36H		"6"----36H
content	"0"----30H	content	"0"----30H

	"0"----30H	Data of address 2104H	"0"----30H
	"0"----30H		"0"----30H
	"2"----32H		"2"----32H
	"1"----31H		"1"----31H
	"3"----33H		"3"----33H
	"8"----38H		"8"----38H
	"8"----38H		"8"----38H
LRC CHECK	"5" ----35H	LRC CHECK	"5" ----35H
	"C" ----43H		"C" ----43H
END	CR ----0DH	END	CR ----0DH
	LF ----0AH		LF ----0AH

RTU mode:

Asking for information string format		Answering information string format	
Address	00H	Address	01H
Function code	06H	Function	code
Content	00H	Content	00H
	02H		02H
	13H		13H
	88H		88H
CRC CHECK Low	25H	CRC CHECK Low	25H
CRC CHECK High	5CH	CRC CHECK High	5CH

Function code: 08H Communication loop test

This command is used to test the communication between main control equipment and inverter. Inverter receives and sends back the message to the main control equipment.

Asking for information string format		Answering information string format	
header	“:”----3AH	Header	“:”----3AH
Address	“0”----30H	Address	“0”----30H
	“1”----31H		“1”----31H
Function code	“0”----30H	Function code	“0”----30H
	“8”----38H		“8”----38H
content	“0”----30H	content	“0”----30H
	“1”----31H		“1”----31H
	“0”----30H		“0”----30H
	“2”----32H		“2”----32H
	“0”----30H	Data from address 2104H	“0”----30H
	“3”----33H		“3”----33H
	“0”----30H		“0”----30H
	“4”----34H		“4”----34H
LRC CHECK	“E” ----45H	LRC CHECK	“E” ----45H
	“D” ----44H		“D” ----44H
END	CR ----0DH	END	CR ----0DH
	LF ----0AH		LF ----0AH

RTU mode:

Asking for information string format		Answering information string format	
Address	01H	Address	01H
Function code	08H	Function code	08H
Content	01H	content	01H
	02H		02H
	03H		03H
	04H		04H

CRC Low	CHECK	41H	CRC CHECK Low	41H
CRC High	CHECK	04H	CRC CHECK High	04H

Check code:

ASCII mode: Double byte ASCII code

Calculation method:

For message sending end, the calculation of LRC is the method of continuous accumulation the byte from "slave address" to "running data" which is not converted to ASCII code, discarding carry-over, reversing the 8 bit data, then plus 1 (converting to complement), finally converted to ASCII code, putting into the checkout area, high byte in front, low byte in post. For The message receiving end, the same LRC method is used to calculating checksum of received data, and comparing it with the received checksum. If they are equal, the message received is correct. If not equal, the received message is wrong. If error, the message frame is discarded with no answering, while the end continuing to receive the next frame data.

RTU mode: two bytes of 16 hex

The CRC domain is two bytes, including a binary value of 16 bits. It is calculated and added to the message by the sending end; while low byte added in front, and high byte added in post then, so the high byte of CRC is the last of the message. The receiving device re-calculates the CRC of the message, and compares it with the CRC in receiving domain, if the two values are different, it means there is error in received message, and the message frame is discarded, while there is no responding but waiting for the next frame data. CRC checksum calculation method reference to MODBUS protocol specification.

Communication protocol parameter definition

definition	Parameter address	Function description
Internal setting parameters	GGnnH	GG means parameter group , nn means parameter number

Commands to inverter (06H)	2000H	0001H: RUN
		0002H: FWD
		0003H: REV
		0004H: JOG
		0005H: FWD JOG
		0006H: REV JOG
		0007H: DEC and STOP
		0008H: STOP
		0009H: JOG STOP
		000AH: RESET
	2001H	Freq. setting
Monitoring inverter (03H)	2100H	Read ERROR code
	2101H	State of inverter
		BIT0: STOP sign, 0: STOP; 1: RUN
		BIT1: Under voltage sign, 1: Under voltage; 0: Normal
		BIT2:FWD REV sign, 1: REV; 0: FWD
		BIT3:JOG sign, 1: JOG; 0: NON JOG.
		BIT4:Close loop control, 1: Close; 0: Non close
		BIT5: swing freq. sign, 1: swing; 0: non swing.
		BIT6:PLC run sign, 1: PLC run, 0: non PLC
		BIT7:terminal multi-stage speed, 1: multi-stage 0: non multi-stage
		BIT8:normal running, 1: normal; 0: non.
		BIT9:Freq. from comm., 1: yes; 0: no.
		BIT10:Freq. from analog input, 1: yes; 0: no.
		BIT11:run commands from comm., 1: yes; 0: no.
BIT12: parameter password protection , 1: yes; 0: no.		

	2102H	Read Freq. setting
	2103H	Read output Freq.
	2104H	Read output current
	2105H	Read bus voltage
	2106H	Read output voltage
	2107H	Read motor speed
	2108H	Read module temp.
	2109H	Read VI analog input
	210AH	Read CI analog input
	210BH	Read software version
Read function code (03H)	GGnnH (GG: function code number. nn :function code number)	Responding function code
Read function code (06H)	GGnnH (GG: function code number. nn :function code number)	Function code writing into inverter

error code:

Error code	Description
01H	Function code error. it can not be identified: 03H, 06H, 08H.
02H	Address error. it can not be identified
03H	Data error. Data overrun