

CBCAN

**CANopen Communication Board User's
Manual**

V1.4

03 Oct. 2012

Table of Contents

Table of Contents	2
Tables	4
Figures.....	5
1. Overview.....	7
2. Specifications	7
3. Installation and Wiring.....	8
4. PLC Application Interface.....	9
4.1 Communication interface area.....	9
4.2 Parameter data area.....	9
4.3 Process data area.....	9
4.4 Module status area.....	10
5. LED Indicators	11
6. EasyCANopener Software Operations	12
6.1 PLC connection	13
6.2 Configuration setup.....	13
6.2.1 Create new configurations.....	13
6.2.2 Save configurations to files.....	19
6.2.3 Open old configuration files.....	19
6.2.4 Read CBCAN Board configurations	19
6.2.5 Write configurations to CBCAN Board	20
6.2.6 Generate EDS files	20
6.2.7 End configuration setup.....	21
6.3 SDO Service.....	21
6.3.1 SDO Read	21
6.3.2 SDO Write	22
6.3.3 SDO Batch.....	22
6.4 PLC remote monitoring service.....	24
6.4.1 Open service	25
6.4.2 Run service	25
6.5 NMT Services.....	26
6.6 CBCAN Firmware Update.....	26
6.6.1 Select firmware files	27
6.6.2 Start firmware update.....	27

6.7 End operations.....	27
7. CBCAN SDO and NMT Service PLC Interface	28
7.1 SDO Service.....	28
7.2 NMT Service.....	30
7.3 Example – NMT Service (Start Remote)	31
Appendix A.....	32
1.1 Application Notes.....	32
1.1.1 Connect CBCAN to a CANopen master device	32
1.1.2 Connect CBCAN to a CANopen slave device	37
1.1.3 Simple example – Connect two FBs PLCs to each other through CBCAN modules	43
Appendix B.....	48
CBCAN Board Object Dictionary	48

Tables

Table 1: CBCAN specification	7
Table 2: Definition of the pinning for the CBCAN connector	8
Table 3: Process data area	9
Table 4: Module status area	10
Table 5: Run LED	11
Table 6: ERR LED	11
Table 7: Run LED – Single status indicator mode.....	12
Table 8: PLC Registers for SDO Service.....	28
Table 9: Registers Status after SDO Service Execution	29
Table 10: SDO Error Code.....	29
Table 11: Registers values of Start Remote command	31
Table 12: Example – network configuration	32
Table 13: Example - network configuration	38
Table 14: Configuration Table.....	44

Figures

Figure 1: CBCAN Top View	8
Figure 2: FBs Top View	8
Figure 3: CANopen line termination	8
Figure 4: Term jumper location.....	8
Figure 5: Indicator status and flash rate	11
Figure 6: EasyCANOpener main page	12
Figure 7: Comm. setup.....	13
Figure 8: Configuration setup	13
Figure 9: RPDO setup page	14
Figure 10: RPDO pop-up menu	14
Figure 11: Edit RXPDO	15
Figure 12 Transmission type	16
Figure 13: TXPDO setup page.....	17
Figure 14: Misc. setup page	18
Figure 15: Read configuration comm. setup.....	19
Figure 16: Node scan page	20
Figure 17: Search result window	20
Figure 18: Generate EDS file	21
Figure 19: SDO service page.....	21
Figure 20: SDO read page.....	22
Figure 21: SDO write page	22
Figure 22: SDO batch page.....	23
Figure 23: SDO batch setup page	23
Figure 24: Pop-up menu for creating batch	23
Figure 25: Add a SDO command.....	23
Figure 26: PLC remote monitoring service	25
Figure 27: Gateway status window	25
Figure 28: Winproladder connection setup page	26
Figure 29: NMT service	26
Figure 30: Firmware update	27
Figure 31: Firmware information.....	27
Figure 32: NMT Start Remote command – Ladder program example.....	31
Figure 33: Example Network	32
Figure 34: Main page.....	33
Figure 35: Module configuration page	33
Figure 36: Node ID configuration.....	33
Figure 37: Baud Rate configuration	33
Figure 38: Removing RXPDOs	34
Figure 39: RXPDO setting page	34
Figure 40: RXPDO1 configuration for this application.....	35
Figure 41: Removing TXPDOs.....	35
Figure 42: TXPDO settings.....	35
Figure 43: TXPDO transmission parameters settings.....	36
Figure 44: Write configuration to CBCAN.....	37
Figure 45: Example network.....	37
Figure 46: Main page.....	38

Figure 47: Module configuration page	39
Figure 48: Node ID configuration.....	39
Figure 49: Baud Rate configuration	39
Figure 50: Removing RXPDOs	40
Figure 51: RXPDO setting page	40
Figure 52: RXPDO1 configuration for this application.....	41
Figure 53: Removing TXPDOs.....	41
Figure 54: TXPDO settings.....	41
Figure 55: TXPDO transmission parameters settings.....	42
Figure 56: Write configuration to CBCAN.....	43
Figure 57: FBs-24MC connect to FBs-20MC	44
Figure 58: FBs-24MC RXPDO Setting	45
Figure 59: FBs-24MC TXPDO Setting.....	45
Figure 60: FBs-24MC Misc Setting	46
Figure 61: FBs-20MC RXPDO Setting	46
Figure 62: FBs-20MC TXPDO Setting.....	46
Figure 63: FBs-20MC Misc. Setting	47
Figure 64: FBs-24MC and FBs-20MC Ladder Program	47

CBCAN Board User's Manual

1. Overview

The CBCAN board is the communication board of the FBs PLC series from FATEK. It can be directly mounted on the extension board slot of the CPU module without the additional space. With the CBCAN, the PLC can directly communicate with other devices connected to the CANopen network.

CANopen is a CAN-based industrial protocol and is widely used in field applications, such as automatic controls for industrial machinery, automobile control systems, factory automation, medical equipment control, building automation, remote data collection and control, environmental monitoring and others.

2. Specifications

Table 1: CBCAN specification

Item	Characteristics	
Compliance with	CAN 2.0A , DS301 V4.02	
PDO quantity	RPDO	10, maximum
	TPDO	10, maximum
SDO quantity	Server	1
	Client	1
Application Parameter Object	1,000 registers, maximum	
Sync Master	Configurable sync. time period	
NMT Master	Available via utility tool	
Time Stamp	Consumer	
Error Control	Heartbeat	
Communication Baud Rate	20K, 50K, 125K, 250K, 500K, 750K, 1M, programmable	
Configuration	Remote operation	Supported
	Tooling	PC software EasyCANopener
	Method	Modify via PLC communication port
Remote PLC Programming	Supported	
Vendor ID	2EF (Hexadecimal)	
Signal Terminal	3-pin spring terminal	
Electric Isolation	Yes	
Voltage/Current	5V, 150mA	
Working Temperature	0-60°C	
Storage Temperature	-20-80°C	

3. Installation and Wiring

The CBCAN is a CANopen communication board for FBs series PLC. FBs PLCs provides an extension slot for installing optional communication boards.

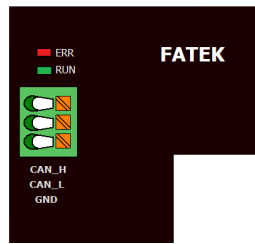

Figure 1: CBCAN Top View

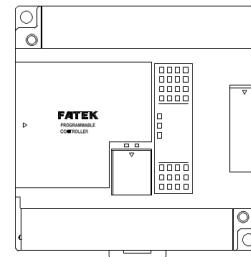

Figure 2: FBs Top View

The CBCAN is connected to the CANopen network via a 3-pin spring style connector.

Table 2: Definition of the pinning for the CBCAN connector

Pin	Signal	Description
1	CAN_H	CAN_H bus line (dominant high)
2	CAN_L	CAN_L bus line (dominant low)
3	CAN_GND	Ground / 0V / V-

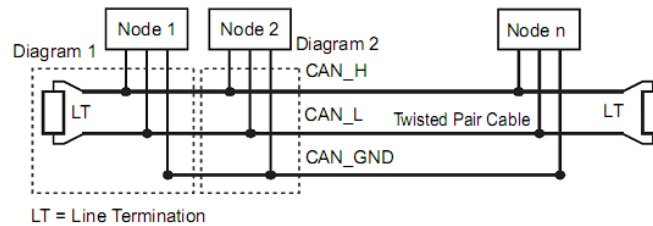

Figure 3: CANopen line termination

Normally for a node located at either left or right most side of network, a 120Ω 1/4W line termination resistor should be connected between CAN_H and CAN_L terminal pins as shown in above picture to ensure the signal quality, but for CBCAN, there's an easier way to implement the same function - short the jumper (JP4) labeled "Term" inside the CBCAN module. The following picture shows the "Term" jumper location of CBCAN.

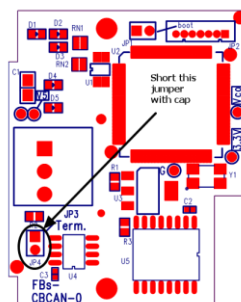

Figure 4: Term jumper location

4. PLC Application Interface

The PLC CPU communicates with the CBCAN board via its internal registers. These registers basically fall into the following areas:

4.1 Communication interface area

In this area, there are 70 reserved registers, ranging from R3700-R3769. These registers shall be reserved for internal system operation and CAN NOT be used for user's applications since the configuration tool EasyCANopener communicates with the CBCAN through this area.

4.2 Parameter data area

The size of this area is configurable up to 1000 registers. From the network point of view, these registers in this area act as objects in that control node. These registers can be addressed by their indexes and sub-indexes, thus they can be accessed by SDO services. With this function, users can change/adjust parameters of users' applications over network easily during system installation in the field.

4.3 Process data area

There are 80 registers in this area, ranging from R3600-R3679. The real-time data of the PLC is exchanged with other nodes on the network via this area.

Table 3: Process data area

Sequence	Item	Function	Register	
1	TPDO1	Word #1	R3600	
2		Word #2	R3601	
3		Word #3	R3602	
4		Word #4	R3603	
5	~	TPDO2	R3604	
~		~	~	
40		TPDO10	R3639	
41		RPDO1	Word #1	R3640
42			Word #2	R3641
43			Word #3	R3643
44	Word #4		R3644	
45	~	RPDO2	R3645	
~		~	~	
80		RPDO10	R3679	

The data length (0-4, with one register size per unit) of each PDO (Process Data Object) is configurable. When the data length is smaller than 4, registers in the front will be used first. For example, if the length of TPDO1 is 2, only the first two registers R3600 and R3601 will be used. The starting register number of each PDO is fixed and will not be changed regardless of the preceding PDO length settings. Any unoccupied registers in this range can be free to use by applications.

4.4 Module status area

Table 4: Module status area

Sequence	Register	Function		
1	R3680	Module Status	<p>Low Byte:</p> <p>Bit 0 : =0, Normal =1, Stopped when excessive RX error occur while startup.</p> <p>Bit 1: Sync signal time-out, valid only if at least one TXPDO is configured in sync. mode.</p> <p>Bit 2: Reserved</p> <p>Bit 3: =1, CAN Rx error</p> <p>Bit 4: =1, CAN Tx error</p> <p>High Byte:</p> <p>Bit[15:8] CBCAN state. =0, init. =5, OPERATIONAL. =4, STOPPED. =127 PRE-OPERATIONAL</p>	
2	R3681	RPDO Status	<p>Each bit represents the receiving status of each RPDO.</p> <p>When Bit =1, it means data update is normal.</p> <p>Bit #0 means RPDO1. Bit #9 means RPDO10.</p>	
3	R3682	Heart beat status	<p>Nodes 1-15</p> <p>When Bit #1=1, it means the heartbeat in Node 1 is detected.</p> <p>The detection cycle is determined by Heartbeat guard Time (refer 6.2.1.4).</p> <p>When Heartbeat guard time = 0, this register is not valid since CBCAN will not monitor heartbeat signals.</p>	
4	R3683		Node 16-31	
5	R3684		Node 32-47	
6	R3685		Node 48-63	
7	R3686		Node 64-79	
8	R3687		Node 80-95	
9	R3688		Node 96-101	
10	R3689		Node 102-127	
11	R3690		Time Stamp	Second (0-59)
12	R3691			Minute (0-59)
13	R3692	Hour (0-23)		
14	R3693	Day (1-31)		
15	R3694	Month (1-12)		
16	R3695	Year (2000-2099)		
17	R3696	Time Stamp packets receiving indication	<p>The value of this register increment by one when a new Time Stamp packet is received and rollover at 65535.</p>	
18	R3697	Ladder software version	<p>The value for ladder software version (Index: 4000H sub-index: 2H) in the object dictionary in decimal. This value will be converted to ASCII characters version, e.g. decimal value 0215 -> ASCII char. '0' '1' '2' '5'</p>	

5. LED Indicators

If the check item “Single status indicator” (refer 6.2.1.4) is not checked, the RUN and ERR Led will be operated as follow:

RUN LED (green) -

Table 5: Run LED

Indicator State	Node Operation State
Single flash	STOPPED
On	OPERATIONAL
Blinking	PRE-OPERATIONAL

ERR LED (red)–

Table 6: ERR LED

Indicator State	Error State
Off	No error
Single flash	Warning limit reach
Triple flash	Rcv. SYNC signal is time-out
Quadruple flash	Any one of expected RXPDOs is time-out
On	Bus off

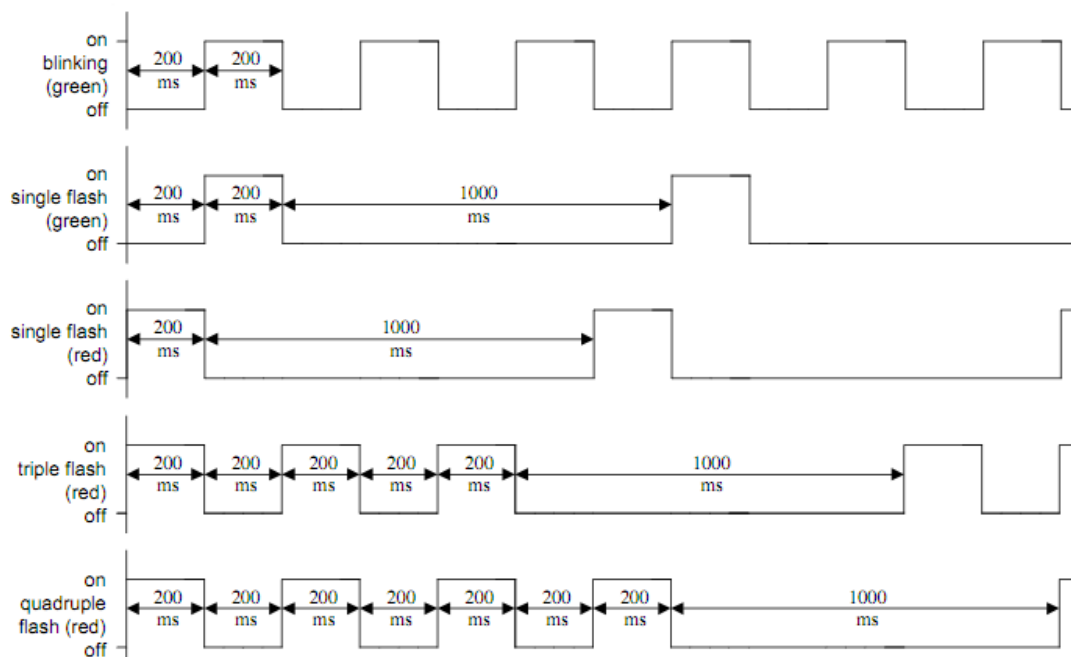

Figure 5: Indicator status and flash rate

The RUN and ERR LED will be operated as follows when the check item “Single status indicator” is checked.

RUN LED (green) –

Table 7: Run LED – Single status indicator mode

Indicator State	Node State
On	Normal network operation(OPERATIONAL)
Blink (period = 1Sec.)	Warning limit reach
Blink (period = 5Sec.)	Bus OFF
Off	Not OPERATIONAL state

ERR LED – Always off.

6. EasyCANOpener Software Operations

Run EasyCANOpener.exe, and the main page will pop up as follows.

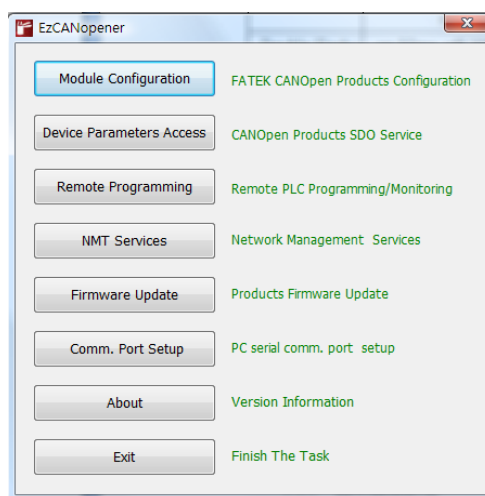

Figure 6: EasyCANOpener main page

Major functions of the software:

- Create, modify and set CBCAN configurations: Users can save configurations into a file to be used for duplication, storage and modification offline.
- SDO Service: Users can either access a single controller object directly or access multiple objects by batch operation. The batch contents can also be saved in files to be re-used in the future.
- PLC remote access bridge: The FBs PLC is usually connected to the Winproladder software via local serial port. When this function is enabled, the CBCAN can work as a remote programming gateway and Winproladder can connect to another FBs PLC at remote site through the CBCAN.
- NMT service: with a single operation, users can send “Start Remote”, “Enter PRE-OPERATIONAL”, “Reset Node”, “Reset Communication” and “Stop” commands to one single node or all nodes on the network.
- CBCAN firmware update: Users can update the firmware of the CBCAN Board on the PLC via the serial port.

6.1 PLC connection

Using this software to modify system settings of the PLC can only be done when the PLC is connected to the software via serial port, except for some offline operations such as creating or modifying configuration and SDO batch files. After the serial port is connected, click the “Comm. Port Setup” function key to set the serial port configuration as shown in the screen below.

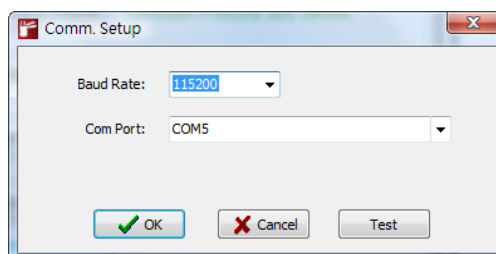

Figure 7: Comm. setup

After the configuration is done, click the “Test” button to start the connection test.

6.2 Configuration setup

Click the “Module Configuration” button on the main page to enter the Configuration Setup screen as shown below.

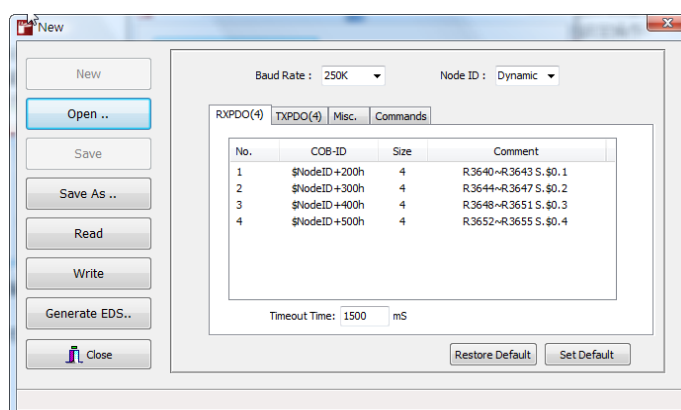

Figure 8: Configuration setup

6.2.1 Create new configurations

When entering the Configuration Setup screen, a new configuration file will be generated automatically and all parameters are in their default values.

6.2.1.1 Basic setup

Functions at the top of configuration setup page as shown in the Figure 8 are described as follows:

Baud Rate: This is the network operating speed. The default value is 250K bps. The range is 20K-1M bps. The same baud rate must be set for all node devices on the network; otherwise, they will not operate properly.

Node ID: This ID is set to indicate the CBCAN’s node id on the CANopen

network and can be configured 1-127 or “Dynamic”. When it is set to “Dynamic”, the node ID will be configured with the same ID as the ID of the PLC CPU module. The advantage of using “Dynamic” is to prevent different CBCANs from using the same ID and causing conflicts, thus each node ID will be unique. Otherwise, the CBCAN will not be able to communicate with other nodes on the CANopen network. The default value for this setting is Dynamic.

6.2.1.2 RPDO setup

Click the RPDO tab to enter the receive process data object (RPDO) setup page as shown in the Figure 9 below.

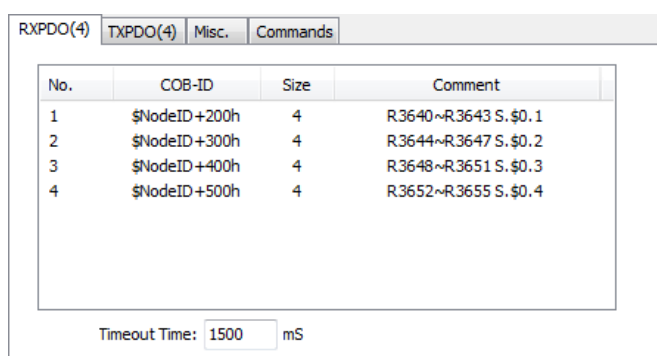

Figure 9: RPDO setup page

The number in parentheses of the tab name represents the quantity of PDOs that has been defined.

As shown in the Figure 9, four RXPDOs have been defined. The RPDO is configured by the popup menu as shown in the Figure 10 below.

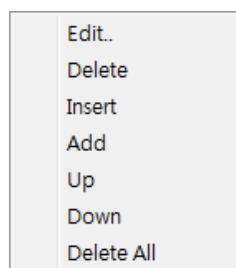

Figure 10: RPDO pop-up menu

The functions in this popup menu are described below.

- Edit: Right-click on the PDO you want to edit to start the pop menu, and select Edit... from the menu. Or, simply double-click the PDO you want to edit to start the following screen.

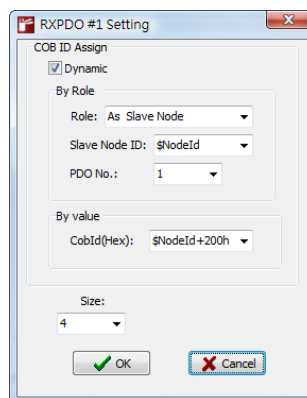

Figure 11: Edit RXPDO

From this screen, users can configure the communication object ID (COB-ID) and data length. Items as shown in the Figure 11 are described as follows.

- **Dynamic option:** A COB-ID can be a fixed value or a value changed with CPU node id. This option is valid only when the current Node ID is set to Dynamic. The COB-ID can be set by either from master or slave perspectives as follows:
 - **By Role:** Basically, every PDO of the master and slave nodes on the network has a default independent COB-ID. The default setting of each node is assigned with four TXPDO COB-IDs and four RXPDO COB-IDs.
 - **By Value:** Input a value between 181H and 5FFH.
 - **Size Setup:** The size of the RXPDO can be set to one to four 16-bit words.
- **Delete:** Right-click the PDO you want to delete and select “Delete” from the pop menu to delete the PDO.
 - **Insert:** Right-click any location where a PDO to be inserted and select “Insert” from the pop menu to start the PDO Edit screen. After the configuration on the popup menu is done, a new PDO will be inserted at the location addressed.
 - **Add:** Right-click the screen to start the popup menu. Select “Add” to start the PDO Edit screen. After the configuration on the popup menu is done, a new PDO will be added at the end of the list.
 - **Up:** Right-click the PDO to be moved up. Select “Up” on the popup menu to move the PDO to one position upward.
 - **Down:** Right-click the PDO to be moved down. Select “Down” on the

popup menu to move the PDO to one position downward.

- Delete All: Right-click on the screen to start the pop menu. Select “Delete All” to delete all PDOs in the list.

There is an additional item “Timeout Time” at the bottom of the RPDO setup page as shown in Figure 9:

Timeout Time: This setting is used to indicate the deadline after the reception of an RPDO message. If RPDO messages are received properly within this interval, the corresponding bit of PLC internal register R3681 “RPDO status” will be set to 1. If not, the bit will be set to 0 to indicate the RPDO timeout event. The default value for this setting is 1.5 seconds.

6.2.1.3 TPDO setup

The TPDO setup is similar to the RPDO’s; this section only described the difference between TPDO and RPDO setup. Please refer to the section 6.2.1.1 for those similar settings.

There is one additional item “Transmission Type” added to the TXPDO Edit page.

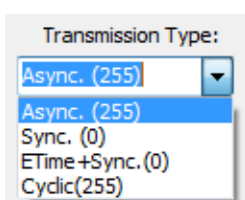

Figure 12 Transmission type

Transmission Type: It indicates the transmission type of the TPDO.

- Async (asynchronous transmission): A TPDO is transmitted when the TPDO data is changed or event time is elapsed without any data change. After TPDO messages are transmitted, the end of the Inhibit Time must be reached before sending next TPDO message. With this function, users can prevent the communication bandwidth from being consumed by unexpected high frequency input signals.
- Sync. (synchronous transmission): Whenever the status change, the TPDO message will be transmitted immediately after the next SYNC message is received.
- ETime+Sync (Event Time + SYNC): It differs from the Sync. mode in one additional transmission condition. In this mode, TPDO messages are also transmitted immediately after the next SYNC message is

received even if the status is not change during pre-defined event time.

- Cyclic: TPDO messages are transmitted periodically in time with the cyclic time setting.

Figure 13 shows the TXPDO setup page. Three general settings for TXPDO transmission type at the bottom of the setup page are described as follows.

The screenshot shows the TXPDO(4) setup page with a table of configurations and timing settings at the bottom.

No.	COB-ID	Size	Comment
1	\$NodeID+180h	4	R3600~R3603 S,\$0.1
2	\$NodeID+280h	4	R3604~R3607 S,\$0.2
3	\$NodeID+380h	4	R3608~R3611 S,\$0.3
4	\$NodeID+480h	4	R3612~R3615 S,\$0.4

Timing settings at the bottom of the page:

Inhibit Time: 100 mS Event Time: 1000 mS Cyclic Time: 2000 mS

Figure 13: TXPDO setup page

Inhibit Time: The minimum transmission time interval when TXPDO are transmitted in Async. mode. After the transmitting of TXPDO messages, the next TXPDO message will not be sent until the end of inhibit time even if the status is changed during the inhibit time period. The default value is 100ms.

Event Time: The maximum transmission time interval when TXPDO are transmitted in Async. mode. After the transmitting of TXPDO messages, the next TXPDO message will be sent immediately after the end of event time even if the status is not changed during the event time period. The default value is 1 second.

Cyclic Time: The transmission time interval used in the Cyclic mode. The default value is 2 seconds.

6.2.1.4 Miscellaneous

Click the “Misc.” tab to edit miscellaneous setup as shown in the Figure 14 below.

Figure 14: Misc. setup page

Heartbeat: This represents the existence of a node within a specific time interval. In normal circumstances, a node will send a heartbeat signal at a regular interval. Other nodes determine if this node is operating normally based on this signal.

- **Cycle Time:** This represents the regular interval the node sends the heartbeat signal. If the value is “0”, this means the heartbeat function is disabled.
- **Guard Time:** This represents the time criteria for a node to detect if the heartbeat of other nodes is normal. In general, individual nodes have individual cycle times, thus users should set different cycle times for different nodes. However, this system assumes that the cyclic time of all nodes are the same in order to simplify the configuration process. In this case, the value must be greater than the default value.

Parameter Data: In general, there are usually some parameters that do not change frequently. These parameters can be mapped to the CANOpen objects through the SDO (Service Data Object) service for remote access over the network.

- **Size:** This setting is to indicate the quantity of the mapped registers. The maximum value is 1000.
- **Start Address:** This represents the start address of the mapped register. Only R-registers can be mapped as parameter registers.

Sync. Master option: When this option is enabled (checked), the CBCAN will operate as the sync. master node which transmits synchronous messages. If this option is disabled and any TXPDO is configured in sync mode, the CBCAN will monitor sync messages produced by the sync master on the network. If the sync master does not generate the sync messages within the pre-defined sync timeout time, a timeout event will be

generated (R3680 Bit1).

- **Sync. Time:** When Sync master option is enabled, this value represents the interval of synchronous messages transmission. When Sync master option is disabled, this value represents the sync timeout time for sync messages monitoring. A longer timeout time than the sync messages interval shall be given for getting the monitoring mechanism works properly.

Auto Start option: When “Auto Start” function is enabled, CBCAN enters OPERATIONAL state from PRE-OPERATIONAL state automatically after power up.

Single Status Indicator: CBCAN provides two types of status indicator. When “Single Status Indicator” is enabled, CBCAN only uses RUN LED for status identification. Please refer to the chapter 5 for detailed flash rates.

6.2.1.5 Commands

By inputting commands via this function, users can make additional configurations for the CBCAN Board.

6.2.2 Save configurations to files

Click the “Save...” or “Save As” button. The save configuration window will pop up. Input the name of the file to be saved and click the “Save” button to save the configurations.

6.2.3 Open old configuration files

Click the “Open...” button. The open configuration file window will pop up. Click the  button and select the configuration files that have been saved. Click the OK button to open the selected configuration file.

6.2.4 Read CBCAN Board configurations

Click the “Read” button. The Comm.Setup window as shown below will pop up.

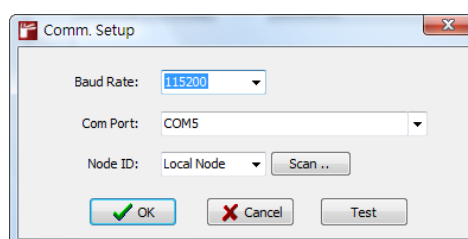

Figure 15: Read configuration comm. setup

The Baud Rate and Comm. Port are the parameters for the PC serial communication port.

Node ID: This presents the ID (1-127) of the CBCAN node to be read. If Local Node is selected, the system will read the contents of the CBCAN which mounted on the local PLC connected to the PC directly.

Scan button: Click this button to scan nodes on the network. The screen is shown below:.

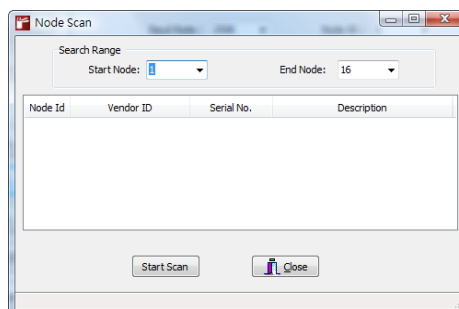

Figure 16: Node scan page

- Search Range: By setting the search range, users can narrow the scan range to save more time.
- Start Node: The ID of the start node for the scan.
- End Node: The ID of the end node for the scan.

Click the “Start Scan” button to start scanning. By clicking the “Stop Scan” button, users can end the scan immediately. The information of the searched modules as shown below will be listed in the window.

Node Id	Vendor ID	Serial No.	Description
1	02EF (Fatek)	0	Fatek CBCAN
2	02EF (Fatek)	0	Fatek CBCAN

Figure 17: Search result window

Information shown in the Vendor ID and CBCAN Serial number can help users to select a module.

Read Completion: After setting the above items, click the OK button to complete reading CBCAN Board configurations.

6.2.5 Write configurations to CBCAN Board

The operations are similar to section 6.2.4. The only difference is the clicking of the “Write” button. Please refer to Section 6.2.4 for details.

6.2.6 Generate EDS files

Select “Generate EDS...”. The Generate EDS File window will pop up.

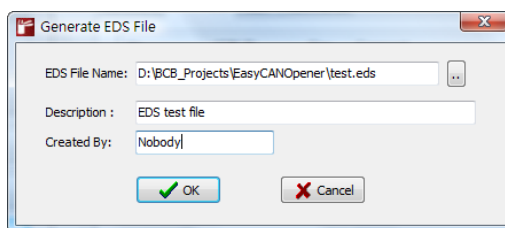

Figure 18: Generate EDS file

Description: Additional descriptions of the EDS file.

Created By: The name of the author who creates the EDS file.

The settings of two items above will be included in the EDS file.

Click the “OK” button to finish creating the EDS file.

6.2.7 End configuration setup

Click the “Close” button to exit the relevant configuration setup functions.

6.3 SDO Service

Click the “Device Parameter Access” button on the main page to enter the SDO Service screen as shown below. The setup items are described below.

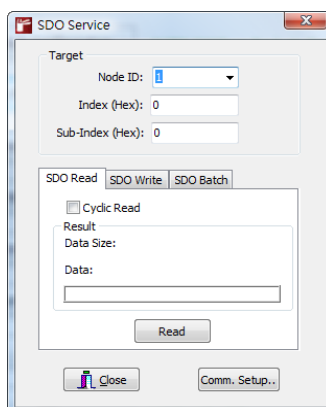

Figure 19: SDO service page

Node ID: This represents the ID of the node you want to access.

Index: This represents the main index of the object.

Sub-Index: This represents the sub-index of the object.

6.3.1 SDO Read

Click the SDO Read tab to enter the SDO Service screen as shown below.

Cyclic Read option: Select (check) this option to read SDO data repeatedly. This function is useful for observing the dynamic change of objects.

Read button: Click the button to start reading SDO data. The results will be displayed in the window as shown below.

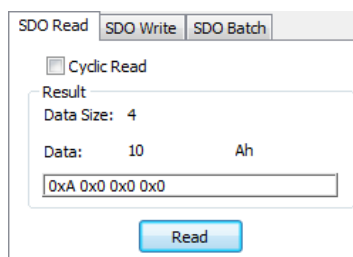

Figure 20: SDO read page

The value “4” in the Data Size item means that the size of the data is 4 bytes. The data content are given in decimal (10), hexadecimal (AH) and string type (0xA 0x0 0x0 0x0).

6.3.2 SDO Write

Click the SDO Write tab to enter the SDO Write service screen as shown below.

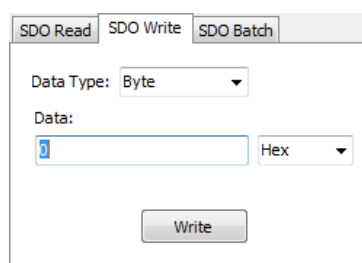

Figure 21: SDO write page

Data Type: This means the type of object data. At present, the system supports only Byte, Word and Dword data.

Data: The value you want to input. Users can select data format from the pull-down list next to the box: Hex (hexadecimal) or Decimal.

Write button: Click the button and start writing. An error window will pop up if there is any error.

6.3.3 SDO Batch

By using the SDO Batch, a list of pre-defined multiple SDO commands can be sent out sequentially. It is very useful when multiple CBCAN modules need to be set up with similar configuration, thus users don't need to configure all functions one by one.

First, click the SDO Batch tab to enter the SDO Batch screen as shown below.

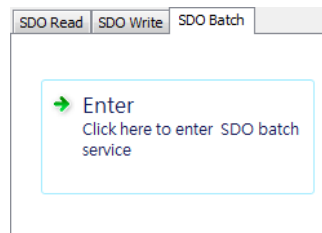

Figure 22: SDO batch page

Click on the SDO batch window as shown in Figure 22 to start SDO Batch editing below.

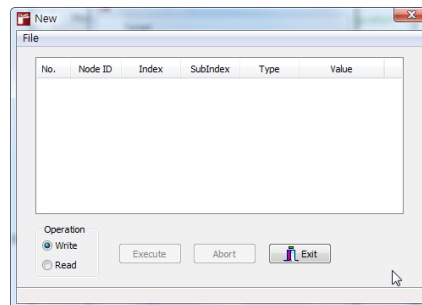

Figure 23: SDO batch setup page

6.3.3.1 Create batch contents

After entering the SDO Batch service screen, there should be no batch contents. Then, users can create the batch content. The menu pops up as shown below.

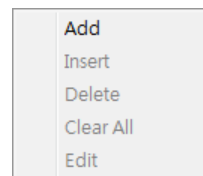

Figure 24: Pop-up menu for creating batch

Add: Right-click the batch content window and select “Add” from the pop menu to start the following window.

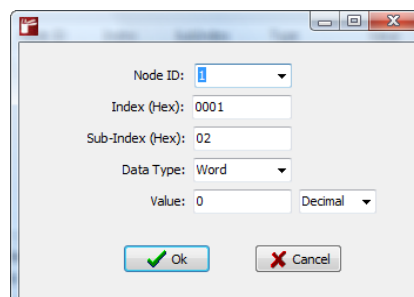

Figure 25: Add a SDO command

- Node ID: Select the ID of the node you want to write SDO data to.
- Index: Input the index value.

- Sub-Index: Input the sub-index value.
- Data Type: Select SDO data type: Byte, Word or Dword.
- Value: Input a value.

Click the OK button to complete creation of the new batch content.

Insert: Right-click the location where the batch command to be inserted and select “Insert” from the pop-up menu. Click the “OK” button to insert a new batch command in the specified location.

Delete: Right-click the batch item you want to delete and select “Delete” from the pop-up menu to delete the SDO command.

Delete All: Right-click the batch content window and select “Delete All” from the pop-up menu to delete all batch commands.

Edit: Right-click the batch item you want to edit and select “Edit” from the pop-up menu or double-click the command item to edit its content. Then, click the “OK” button to complete modifying the content.

6.3.3.2 Save batch contents

Click “File” from the main menu at the top of the window and click “Save” or “Save As” from the pull-down to save the current batch contents in a file.

6.3.3.3 Read this batch file

Click “File” from the main menu at the top of the window and click “Open” from the pull-down list to read the contents of the batch file.

6.3.3.4 Execute batch write

First, select the “Write” option in the operation group. Then, click the “Execute” button to start batch write. SDO write commands will be sent out according to the contents in the batch window.

6.3.3.5 Execute batch read

First, select the “Read” option in the operation group. Then, click the “Execute” button to start batch read. SDO read commands will be sent out according to the contents in the batch window. It differs from “batch write” in the read-back values will overwrite the original ones.

6.4 PLC remote monitoring service

With this service, the ladder programming software Winproladder from Fatek can connect to the remote PLC equipped with the CBCAN Board via the PC serial port, thus ladder programs on the remote PLC can be modified locally through local PLC equipped with CBCAN module.

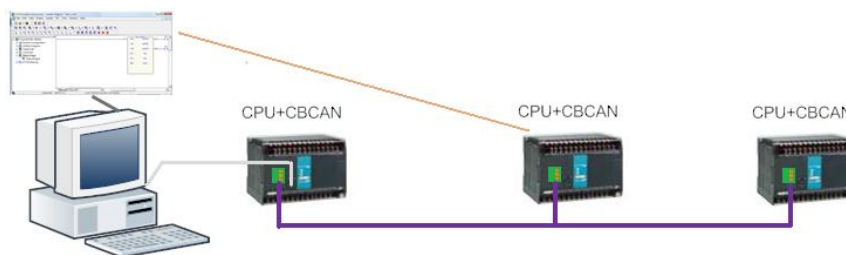

Figure 26: PLC remote monitoring service

6.4.1 Open service

Click the “Remote Programming” button on the main page to enter the remote monitoring service screen as shown below.

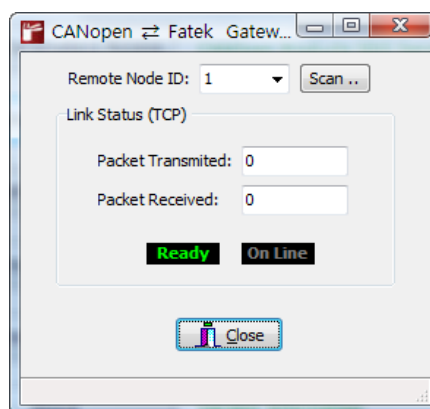

Figure 27: Gateway status window

Items in the screen are described as follows:

Remote Node ID: Input the ID of the node which you want to connect.

Link Status: Auxiliary status.

Packet Transmitted: The quantity of data packets transmitted to the remote PLC.

Packet Received: The quantity of data packets received from the remote PLC.

This service is completed through the local CBCAN module which operates as a gateway between the remote PLC and local Winproladder software. It is based on the TCP communication at port 500.

Ready: When the system is ready for the service, the button is green.

On Line: When the TCP network and application are linked, the button is green.

6.4.2 Run service

Users must connect to local machine IP 127.0.0.1 at port #500 via TCP connection to subscribe the service. Therefore, an example of Winproladder

settings is shown below:

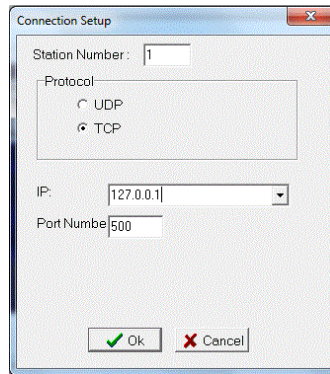

Figure 28: Winproladder connection setup page

As it is connected via the TCP communication, users can link up with the CANopen network with Ethernet from a remote site.

6.5 NMT Services

Click the “NMT Service” button on the main page to enter the NMT Services screen as shown below.

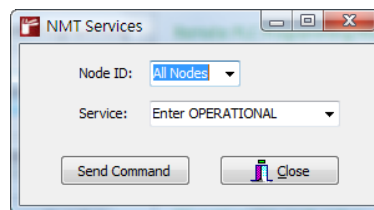

Figure 29: NMT service

Node ID: Input the ID of the NMT slave node to be managed. Users can select either a single node (1-127) or all nodes.

Service: The service includes:

“Start Remote”, “Enter PRE_OPERATIONAL”, “Reset Node”, “Reset Communication”, “Stop”

After the configuration is done, click the “Send Command” button to start NMT service.

6.6 CBCAN Firmware Update

Click the “Firmware Update” button on the main page to enter the Firmware Update screen as shown below.

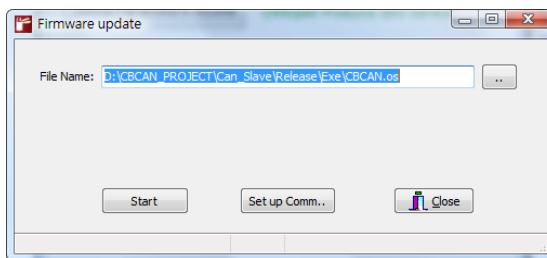



Figure 30: Firmware update

Note. The CBCAN firmware version can be read from object index 4000H sub-index 1.

File Name: Input the file name of the firmware to be updated.

6.6.1 Select firmware files

Click the  button to open the file selection window. After selecting the firmware file, press the “OK” button. The following confirmation dialog box will pop up.

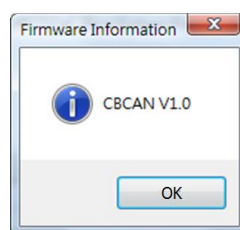

Figure 31: Firmware information

The information of the corresponding firmware file will appear in this dialog box.

6.6.2 Start firmware update

Click the “Start” button to start the firmware update.

6.7 End operations

Click the “Exit” button on the main page to close EasyCANOpener utility.

7. CBCAN SDO and NMT Service PLC Interface

The current Winproladder design does not provide the SDO and NMT service ladder instructions which are sometimes the necessary functions for some applications. The purpose of this chapter is to provide the PLC interface of the SDO/NMT service which required for users who need to implement the two services in their ladder programs.

7.1 SDO Service

The PLC registers R3700~R3769 are reserved for SDO service when CBCAN module is used on FBs PLC family. The major required information to issue a SDO service are SDO slave's node ID (R3702), index and sub-index of slave's object dictionary (R3703 and R3704), the size of data to be read or write (R3705), and the data itself (R3706~R3769). After this information is input to corresponding registers, the last step is to write R3700 with "CA0Eh" to trigger the SDO service.

The execution results of SDO service will be also shown on the same registers. The detailed description for execution results and register functions are shown on the Table 9 below.

Table 8: PLC Registers for SDO Service

Sequence #	Register	Function
1	R3700	Execute Flag = CA0EH
2	R3701	Command. SDO Read=5055 SDO Write = 5066
3	R3702	Node ID(station number, 0~127. If =0, this node)
4	R3703	Object Index (0~65535)
5	R3704	Object sub-index (0~255)
6	R3705	Object data size: 1 ~ 128 Byte. Data size to Write or max. data buffer size for read
7	R3706	Data word #0
8	R3707	Data word #1
.	.	.
70	R3769	Data word #63

Table 9: Registers Status after SDO Service Execution

Sequence #	Register	Function	
		Read	Write
1	R3700	Result Code* ₁	
2	R3701	No Change	
3	R3702		
4	R3703		
5	R3704		
6	R3705	Actual read data size	No Change
7	R3706	Data word #0* ₂	No Change* ₂
8	R3707	Data word #1* ₃	No Change* ₃
.	.	.	No Change
70	R3769	Data word #63	No Change

*₁: Result Code: OK = 0, CMD_CODE_ERR = 1, NODE_ID_ERR = 2, SDO_EXEC_ERR = 4.

*₂: SDO error code low word if execution is Failed (Result Code= 4)

*₃: SDO error code high word if execution is Failed (Result Code= 4)

Table 10: SDO Error Code

Error Code Name	Error Value	Description
ABORT_TIME_OUT	0x05040000L	SDO service Time out
ABORT_NO_OBJ	0x06020000L	No such object
ABORT_RO	0x06010002L	Attempt to write a read-only object
ABORT_SYS_LENGTH	0x06040047L	Data length exceed system allow
ABORT_NO_SEGEMNT	0x06010000L	Not support segment transfer
ABORT_OBJ_LENGTH	0x06070010L	Not match object length
ABORT_SYNC	0x05040001L	Command specifier not valid
ABORT_TOGGLE_BIT	0x05030000L	Toggle bit not alternated
ABORT_PARM_LENGTH	0x06070012L	Length of service parameter too high
ABORT_WO	0x06010001L	Attempt to read a write-only object
ABORT_READ_LENGTH	0x05040005L	Object length too big to read

7.2 NMT Service

The NMT Service is done by using the SDO service with a specified object index “0x1F82” (write service) or “0x300C” (read service). The detailed steps and register descriptions are as follows.

NMT Management Service – Issue a NMT command to specified node(s)

SDO write (R3701): With Object index (R3703) = 0x1f82

R3704: Sub-Index n	Description
n = 1 ~ 127	Node with node ID n to be requested
n = 128	Request all nodes

R3702: Do not care.

R3706: Command Code	NMT Service Description
5 or 1	Start Remote Node
4 or 2	Stop Remote Node
127 or 128	Enter Pre-Operational State
6 or 129	Reset Node
7 or 130	Reset Communication

Get NMT state service - Get the NMT state of specified node

SDO read (R3701): With Object index (R3703) = 0x300c

Sub-index (R3704) = 0

Node ID (R3702): Requested node ID

Execution Result (R3700 and R3706):

Register	Value	Description
R3700	0	OK
	Not 0	Not OK
R3706 (Only valid when R3700 is 0)	4	Stopped
	127	Pre-operational
	5	Operational
	6	Not detected

7.3 Example – NMT Service (Start Remote)

The ladder example program below shows how to issue a NMT command to start all remote CANopen nodes on the network. To issue the “Start Remote” command, register values should be set as shown in the following table.

Table 11: Registers values of Start Remote command

Register	Value	Description
R3701	5066	Write command
R3703	1F82H	NMT service index
R3704	128	Request all nodes
R3706	5	Start Remote Node

After completing the registers as shown on the Table 11, the last step is to write R3700 with value CA0Eh to trigger the NMT command. The “17.CMP” function on the first network of the ladder example is only used as a trigger of the NMT service and is not a necessary instruction.

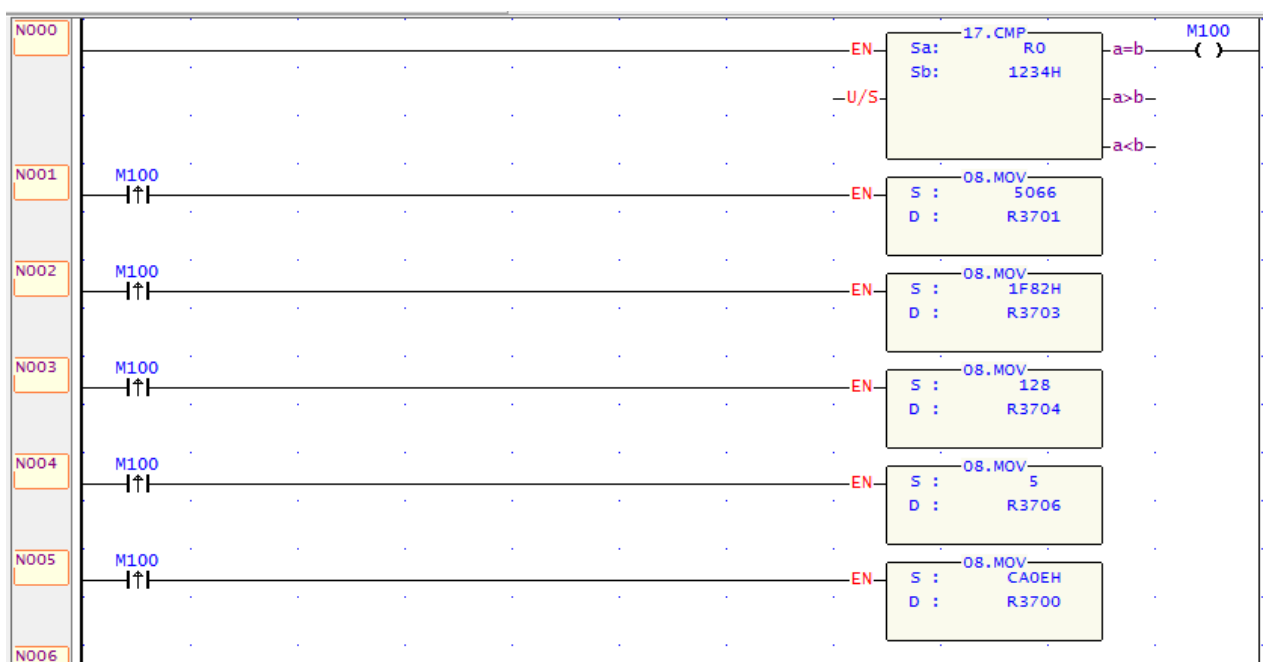

Figure 32: NMT Start Remote command – Ladder program example

Appendix A

1.1 Application Notes

CBCAN is a CANopen communication interface which can be plugged into the FBs series PLC for connecting the PLC with external CANopen devices. Most of CBCAN CANopen objects are configurable via EzCANopener utility and shall be configured properly according to field network requirements. The purpose of this section is to provide a quick configuration reference for users to set up CBCAN modules connected to a CANopen network.

1.1.1 Connect CBCAN to a CANopen master device

In this application, the FBs PLC with CBCAN is used as the CANopen slave node on the network.

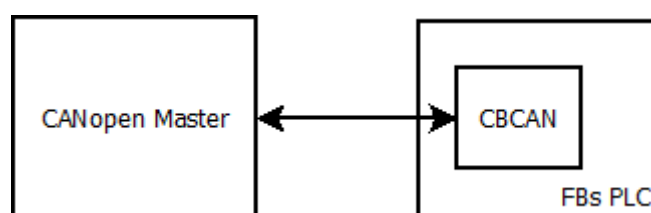

Figure 33: Example Network

Assume the CANopen master uses the configuration in the following table to connect to the CANopen network.

Table 12: Example – network configuration

Items	Values
Node ID	2
Baudrate	125K bps
Sync. master	Disabled
Error control	Heartbeat producer (1000 ms) Heartbeat consumer (1050 ms)
Number of TxPDO	1 (3 words) Transmission type: Async. Mode (255)
Number of RxPDO	1 (3 words)

To connect CBCAN to the master, the node id and baudrate are first items to be configured in terms of master settings. All CBCAN settings can be configured via the CBCAN device configuration of EasyCANopener utility. The CBCAN configuration can be started by clicking the “Module Configuration” button on the main page of EasyCANopener utility.

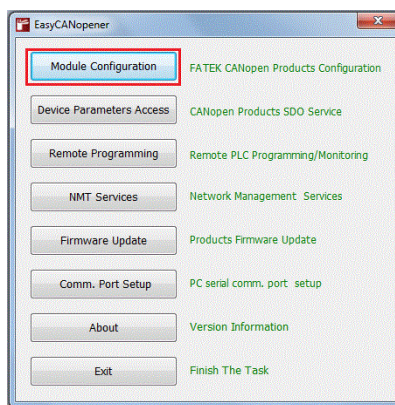

Figure 34: Main page

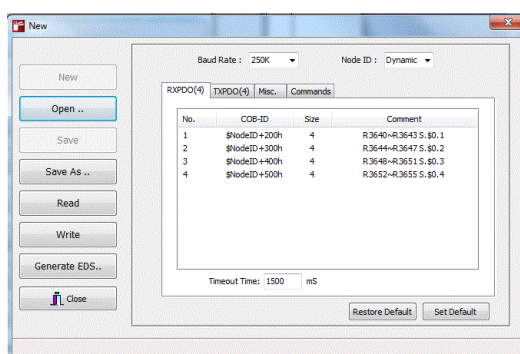

Figure 35: Module configuration page

The master’s node id is 2, thus any other id from 1~127 can be assigned to CBCAN. Assume the FBs PLC uses id node 1, CBCAN node id can simply use PLC’s node id as its CANopen node id because the id is not 2. Choose “Dynamic” option to use PLC’s node id as the CBCAN’s CANope node id.

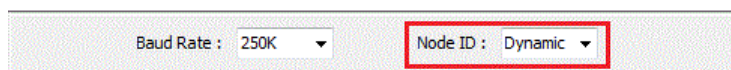

Figure 36: Node ID configuration

The “Baud Rate” setting is located next to the “Node ID”, choose 125K to set up CBCAN serial communication speed to 125 kbps.



Figure 37: Baud Rate configuration

RxPDO Setting

The CANopen master uses transmission type 255 in this application, the PDO messages will only be transmitted whenever events are triggered. The “Timeout Time” setting is not important for this application since the

transmission interval between two consecutive PDO messages is not predictable. The CANopen master only requires 1 RxPDO for exchanging 6-byte data with CBCAN, thus RxPDO2~RxPDO4 are not needed in this application. To remove them, select them and choose the “Delete” on the mouse right click pop-up menu.

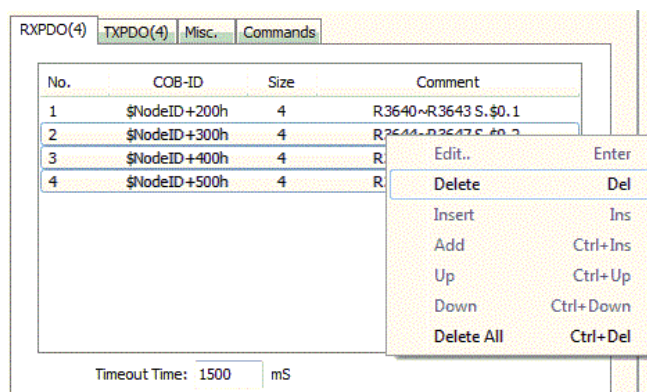

Figure 38: Removing RXPDOs

There should be only RxPDO1 left in the list, double click on it for further configuration.

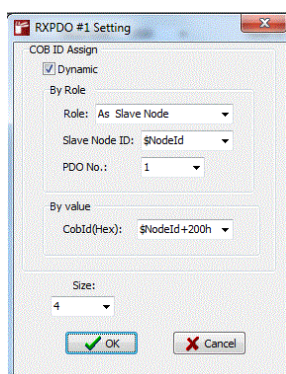

Figure 39: RXPDO setting page

Since the CBCAN node id was configured “Dynamic”, the Dynamic option on this page remains checked to use FBs PLC node id as the slave id. The CBCAN is used to connect to a CANopen master device in this application, choose “As Slave Node” mode to set up the RxPDO’s role as slave. The default setting “\$NodeId” should then be selected for using CBCAN node id as the Slave Node ID. In general, the CANopen master and slave use “slave node id + 200h” as the slave’s RxPDO1’s COB-ID, thus the setting “\$NodeId+200h” should be chosen for CobId(Hex) setting unless otherwise specified. The CBCAN uses the PLC internal register (one-word size) as the base unit for calculating the PDO size, thus the actual size of Size “4” is 8 bytes. As described in the beginning of this section, the CANopen master only

exchanges 6-byte data with CBCAN in this application, the “Size” setting of RxPDO1 shall be configured as 3.

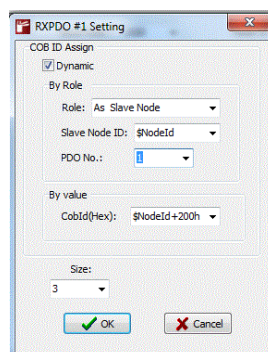

Figure 40: RXPDO1 configuration for this application

TxPDO Setting

As described above, the CANopen master only uses one TxPDO, TxPDO 2~4 shall be removed as well.

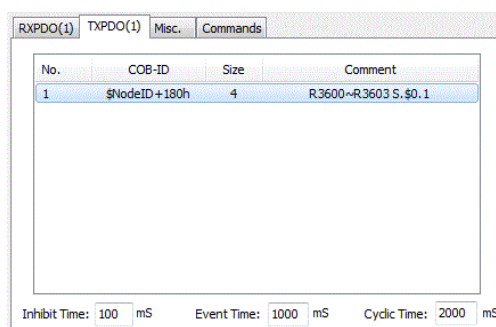

Figure 41: Removing TxPDOs

A similar way to the RxPDO configuration, double click on the TxPDO1 to set up further TxPDO settings.

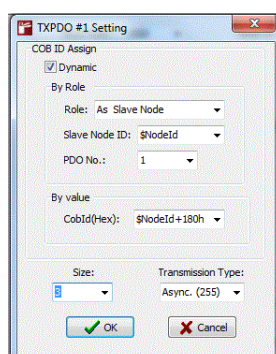
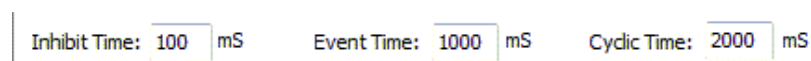

Figure 42: TxPDO settings

Same as RxPDO configurations, the default settings of “Role”, “Slave Node ID”, “PDO No”, and “CobId(Hex)” are required for this application. Therefore, they remain unchanged as shown on the picture above. Change the Size to 3 for

having CBCAN exchange 6 bytes data with the CANopen master. As required in this application, the Async.(255) shall be used as the “Transmission Type” for transmitting PDO messages.

Three additional settings are related to the transmission type and are located at the bottom of TxPDOs list page. “Cyclic Time” is only valid when “Cyclic” transmission type is used. “Inhibit Time” and “Event Time” are two transmission parameters for “Async.(255)” type. In this application, there is no requirement specified for these two parameters. They may use the default settings 1000ms and 100ms for “Event Time” and “Inhibit Time”, respectively. The “Event Time” 1000ms which means the consecutive TxPDO messages shall be transmitted within 1000ms even if no event occurs. The setting 100ms for “Cyclic Time” means the consecutive TxPDO messages will not be transmitted within 100 ms even if events are triggered during that period.



Inhibit Time: 100 mS Event Time: 1000 mS Cyclic Time: 2000 mS

Figure 43: TXPDO transmission parameters settings

Misc. Setting

On Misc. setting page, there are three main functions “HeartBeat”, “Parameter Zone”, and “Sync. Master”. The “Parameter Zone” configuration is not related to the CANopen network communication and can be disabled (set to 0 to disable) for this application. As for the “Sync. Master”, it is not applicable for this application and can be disabled/unchecked because the Async.(255) mode is used as the PDO transmission type.

Since the CANopen master produces heartbeat at 1000 ms period, the CBCAN “Guard Time” shall use a higher value than 1000 ms. In this example, “Guard Time” is set to the value 1050 ms for monitoring the CANopen master heartbeat messages. Likewise, the CBCAN “Cycle Time” shall use a lower value than the CANopen master’s consumer heartbeat time.

Write Configuration to CBCAN

After above settings are done, the configuration then can be downloaded to CBCAN. Click the “Write” button on the main page, a pop-up window will appear for setting up the communication between EasyCANopener utility and CBCAN. The CBCAN on the local node is accessed through the FBs PLC port 0. Choose “Auto” baudrate to have EasyCANopner utility to detect FBs

baudrate setting automatically. Then click “OK” button on the “Comm. Setup” pop-up window to start the configuration downloading.

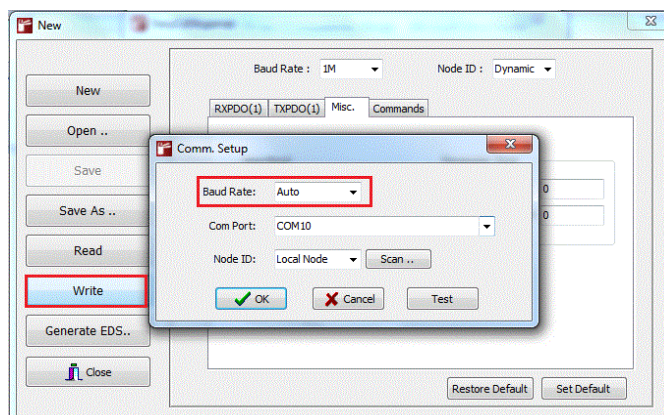

Figure 44: Write configuration to CBCAN

Input and Output image

After downloading the new configuration to the CBCAN, the CBCAN should be able to communicate with the CANopen master. The CBCAN supports maximum 10 RxPDOs and 10 TxPDOs. Each PDO supports maximum 8 bytes data, these data is mapped to the FBs PLC internal registers. The CBCAN integrates the data of RxPDOs into the input image and maps those data to the internal register R3640~R3679. Mapping registers for output image are R3600~R3639, the CBCAN reads data from output image for transmitting TxPDO messages. In this application, the 6-byte data of RxPDO1 is mapped to the register R3640~R3642 and the 6-byte data of TxPDO1 is read from R3600~R3602.

1.1.2 Connect CBCAN to a CANopen slave device

In this application, the FBs PLC with CBCAN is used as the CANopen master node on the network.

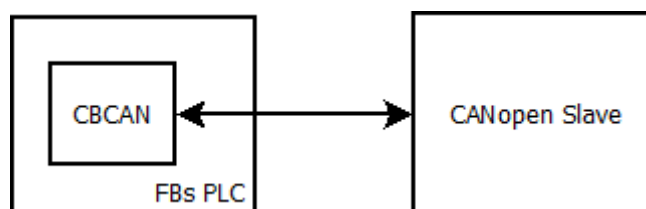

Figure 45: Example network

Assume the CBCAN uses the configuration in the following table to connect to the CANopen network.

Table 13: Example - network configuration

items	Values
Node ID	1
Slave Node ID	2
Baudrate	125K bps
Sync. master	Disabled
Error control	Heartbeat producer (1000 ms) Heartbeat consumer (1050 ms)
Number of TxPDO	1 (3 Words) Transmission type: Async. Mode (255)
Number of RxPDO	1 (3 Words)

To set up CBCAN CANopen communication, the node id and baudrate are first items to be configured in terms of network requirements. All CBCAN settings can be configured via the CBCAN device configuration of EasyCANopener utility. The CBCAN configuration can be started by clicking the “Module Configuration” button on the main page of EasyCANopener utility.

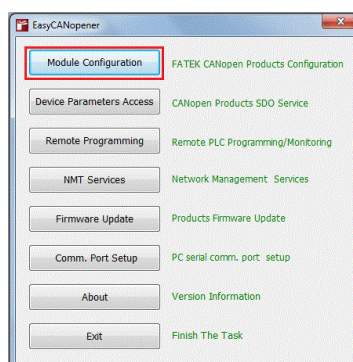
**Figure 46: Main page**

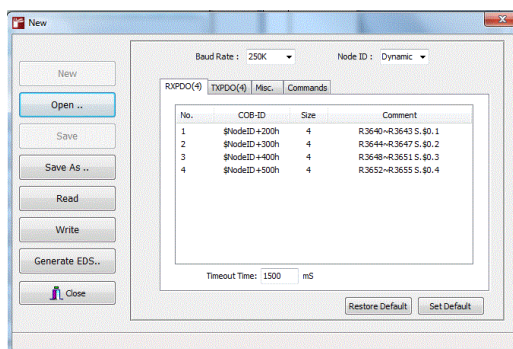

Figure 47: Module configuration page

Assume the FBs PLC uses id node 1, CBCAN node id can simply use PLC's node id as its CANopen node id because it is not 2. Choose "Dynamic" option to use PLC's node id as the CBCAN's CANopen node id.



Figure 48: Node ID configuration

The "Baud Rate" setting is located next to the "Node ID", choose 125K to set up CBCAN serial communication speed to 125k bps.



Figure 49: Baud Rate configuration

RxPDO Setting

The network requires transmission type 255 in this application, the PDO messages will only be transmitted whenever events are triggered. The "Timeout Time" setting is not important for this application since the transmission interval between two consecutive PDO messages is not predictable. The CBCAN only requires 1 RxPDO for exchanging 6-byte data with the CANopen slave node, thus RxPDO2~RxPDO4 are not needed in this application. To remove them, select them and choose the "Delete" on the mouse right click pop-up menu.

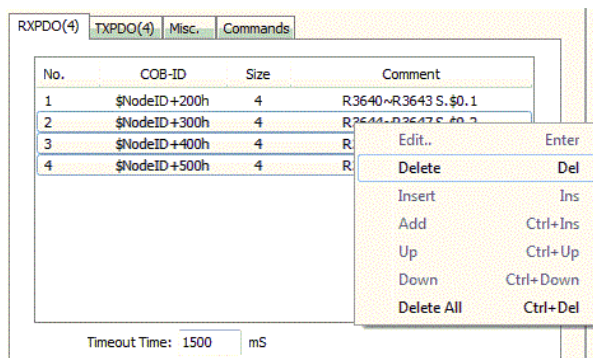

Figure 50: Removing RXPDOs

There should be only RXPDO1 left in the list, double click on it for further configuration.

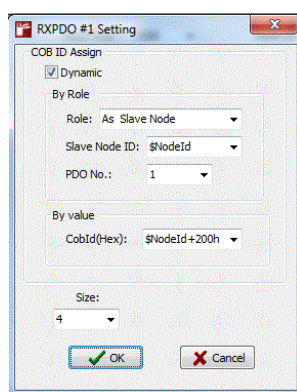

Figure 51: RXPDO setting page

Since the CANopen slave device does not use the same id as CBCAN, it's not necessary to enable "Dynamic" which uses FBs PLC node id as the CANopen slave node id. The CBCAN works as a master device in this application, choose "As Master Node" mode to set up the RXPDO's role as a master. According to the network configuration required by this application, the slave device uses node id 2, thus value 2 is selected as the "Slave Node ID" setting. In general, the CANopen master uses "slave node id + 180h" as the RXPDO1's COB-ID, thus the COB-ID shall set to "182h". (Please also double check if the CANopen slave node uses the general rule to configure its PDO settings.) The CBCAN uses the PLC internal register (one-word size) as the base unit for calculating the PDO size, thus the actual size of Size "4" is 8 bytes. As described in the beginning of this section, the CBCAN only exchanges 6-byte data with the CANopen slave device, the "Size" setting of RXPDO1 shall be configured as 3.

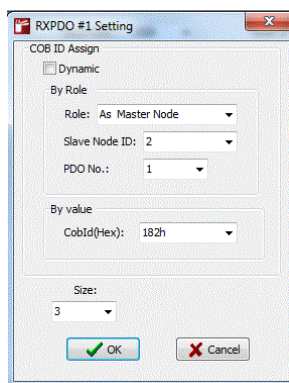

Figure 52: RXPDO1 configuration for this application

TxPDO Setting

The CBCAN only requires one TxPDO to transmit 6-byte data to the slave device, TxPDO 2~4 are not needed and shall be removed for this application as well.

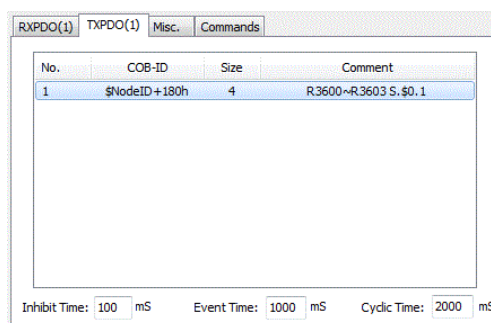

Figure 53: Removing TxPDOs

A similar way to the RxPDO configuration, double click on the TxPDO1 to set up further TxPDO settings.

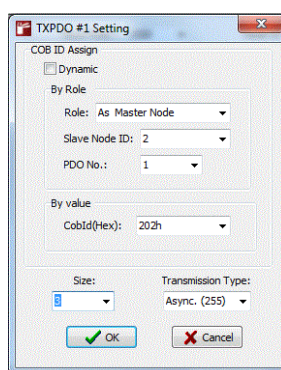

Figure 54: TxPDO settings

Same as RxPDO configurations, the “Role” shall be set to “As Master Mode” and the CobId(Hex) is then changed to “\$NodeId+200h” automatically. The “Slave Node ID” does not use the same node id of FBs PLC, “Dynamic” setting

shall be disabled/unchecked. Select value 2 as the Slave Node ID. The “CobId(Hex)” setting is switch to 202h automatically. This value 202h matches the general rule of using “Slave node ID+200h” as the master’s TxPDOs COB-ID setting. Change the Size to 3 for having CBCAN exchange 6 bytes data with the CANopen master. As required in this application, the Async.(255) shall be used as the “Transmission Type” for transmitting PDO messages.

Three additional settings are related to the transmission type and are located at the bottom of TxPDOs list page. “Cyclic Time” is only valid when “Cyclic” transmission type is used. “Inhibit Time” and “Event Time” are two transmission parameters for “Async.(255)” type. In this application, there is no requirement specified for these two parameters. They may use the default settings 1000ms and 100ms for “Event Time” and “Inhibit Time”, respectively. The “Event Time” 1000ms which means the consecutive TxPDO messages shall be transmitted within 1000ms even if no event occurs. The setting 100ms for “Cyclic Time” means the consecutive TxPDO messages will not be transmitted within 100 ms even if events are triggered during that period.

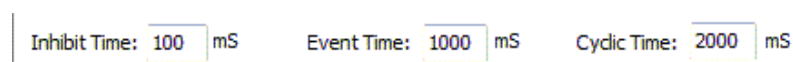

Figure 55: TXPDO transmission parameters settings

Misc. Setting

On Misc. setting page, there are three main functions “HeartBeat”, “Parameter Zone”, and “Sync. Master”. The “Parameter Zone” configuration is not related to the CANopen network communication and can be disabled (set to 0 to disable) for this application. As for the “Sync. Master”, it is not applicable for this application and can be disabled/unchecked because the Async.(255) mode is used as the PDO transmission type.

As required for this application, the CBCAN produces heartbeat at 1000 ms period, thus the “Cycle Time” is set to 1000ms. Assume the CANopen slave also produces heartbeat at 1000ms period, a higher value 1050ms “Guard Time” is set for monitoring the CANopen slave heartbeat messages.

Write Configuration to CBCAN

After above settings are done, the configuration then can be downloaded to CBCAN. Click the “Write” button on the main page, a pop-up window will appear for setting up the communication between EasyCANopener utility and CBCAN. The CBCAN on the local node is accessed through the FBs PLC port 0. Choose “Auto” baudrate to have EasyCANopner utility to detect FBs

baudrate setting automatically. Then click “OK” button on the “Comm. Setup” pop-up window to start the configuration downloading.

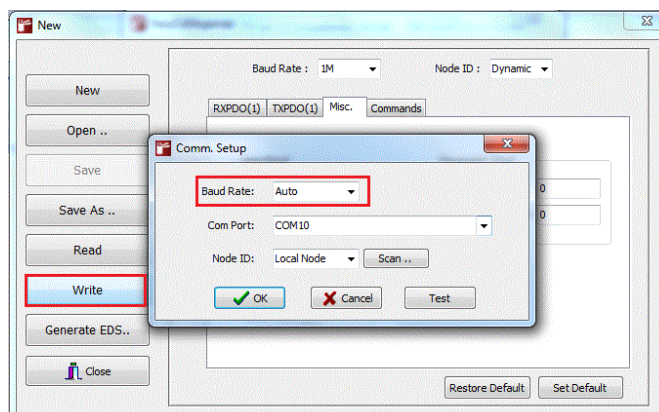

Figure 56: Write configuration to CBCAN

Input and Output image

After downloading the new configuration to the CBCAN, the CBCAN should be able to communicate with the CANopen devices. The CBCAN supports maximum 10 RxPDOs and 10 TxPDOs. Each PDO supports maximum 8 bytes data, these data is mapped to the FBs PLC internal registers. The CBCAN integrates the data of RxPDOs into the input image and maps those data to the internal register R3640~R3679. Mapping registers for output image are R3600~R3639, the CBCAN reads data from output image for transmitting TxPDO messages. In this application, the 6-byte data of RxPDO1 is mapped to the register R3640~R3642 and the 6-byte data of TxPDO1 is read from R3600~R3602.

1.1.3 Simple example – Connect two FBs PLCs to each other through CBCAN modules

A real and simple example is given in this section. The CBCAN configurations and ladder programs are also given below for both the master and slave roles in this example. Two FBs PLCs are used in this demonstration. A FBs-24MC is configured as the master which sends its digital input status (X0~X7) to a FBs-20MC for writing FBs-20MC’s digital output (Y0~Y7). Meanwhile, the FBs-20MC is configured as the slave role which also sends its digital input status (X0~X7) to the FBs-24MC.

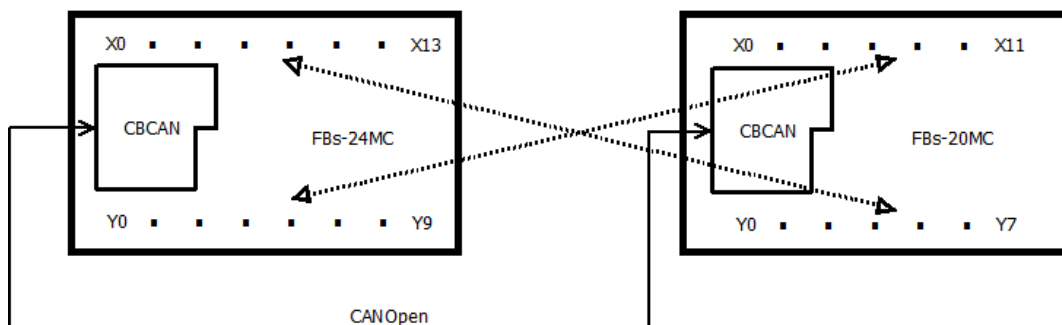

Figure 57: FBs-24MC connect to FBs-20MC

It is suggested to make a table of configuration which can help users to setup the system environment.

Table 14: Configuration Table

Model Name	FBs-24MC	FBs-20MC
Role	Master	Slave
Baud-rate	250Kbps	
Node ID	1	8
RXPDO #	1	1
RXPDO COB-ID	188h	208h
RXPDO Size	1 (indicates the size of incoming data is no larger than 1 word) (incoming data: DI status from 20MC)	1 (indicates the size of incoming data is no larger than 1 word) (incoming data: DI status from 24MC)
TXPDO #	1	1
TXPDO COB-ID	208h	188h
TXPDO Size	1 (indicates the size of outgoing data is no larger than 1 word) (outgoing data: DO status to be sent to 20MC)	1 (indicates the size of outgoing data is no larger than 1 word) (outgoing data: DO status to be sent to 24MC)
TXPDO Transmission Type	Asnyc. (255)	Asnyc. (255)
Heart Beat	No particular requirement. Default setting is used. Cycle Time: 1000 ms Guard Time: 1050 ms	No particular requirement. Default setting is used. Cycle Time: 1000 ms Guard Time: 1050 ms
Sync. Master	OFF (Asnyc. transmisson)	OFF (Asnyc. transmisson)
Auto. Start	ON (indicates the PDO	ON (indicates the PDO

	transmissions will start automatically after boot-up)	transmissions will start automatically after boot-up)
--	---	---

The next step is to configure FBs-24MC and FBs-20MC by using EasyCanOpener utility according to the information from the configuration table above. The detailed configurations are shown on the snapshots Figure 58~Figure 63 below.

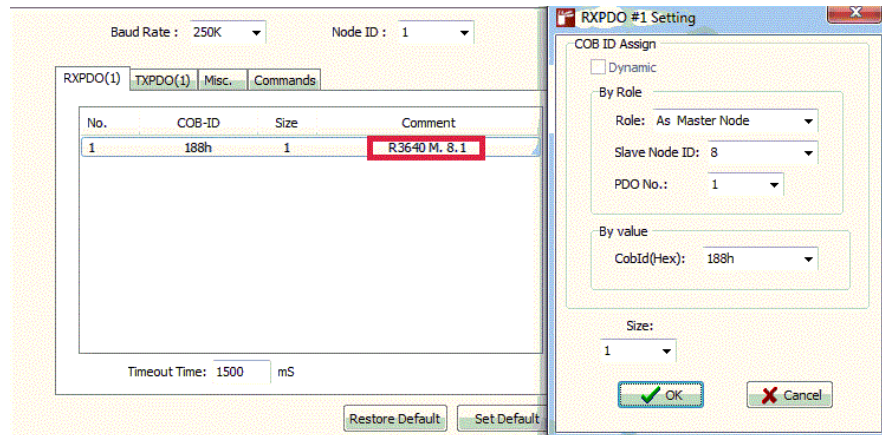

Figure 58: FBs-24MC RXPDO Setting

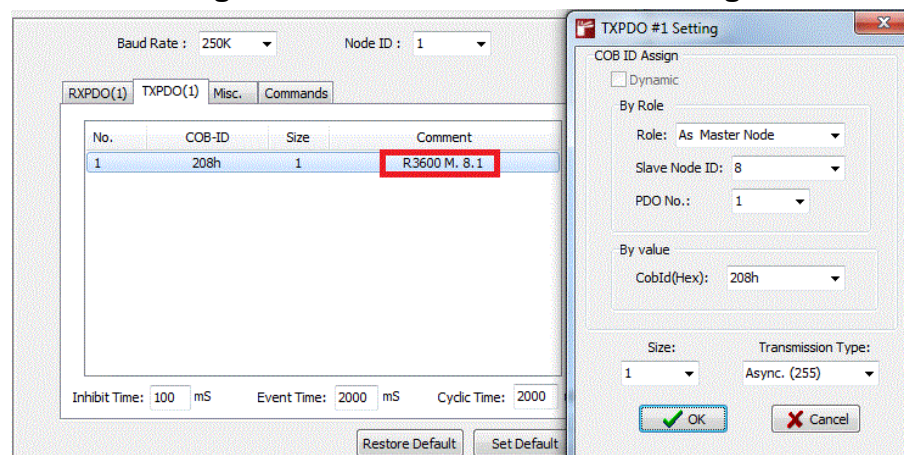

Figure 59: FBs-24MC TXPDO Setting

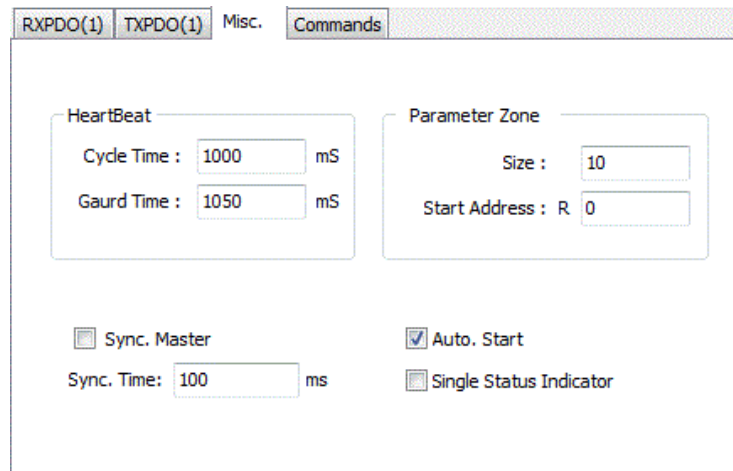

Figure 60: FBs-24MC Misc Setting

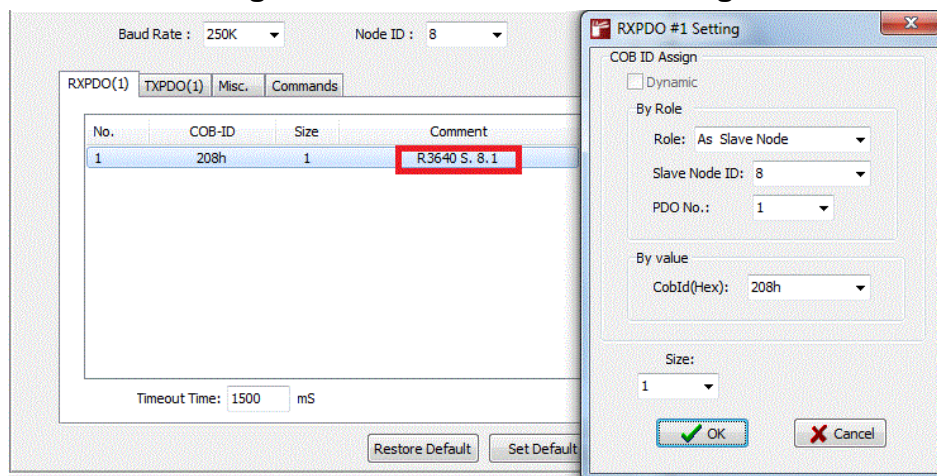

Figure 61: FBs-20MC RXPDO Setting

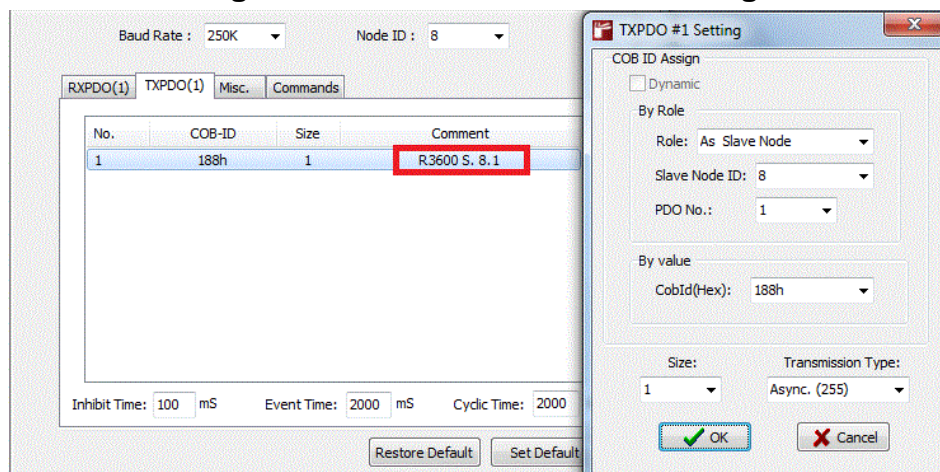

Figure 62: FBs-20MC TXPDO Setting

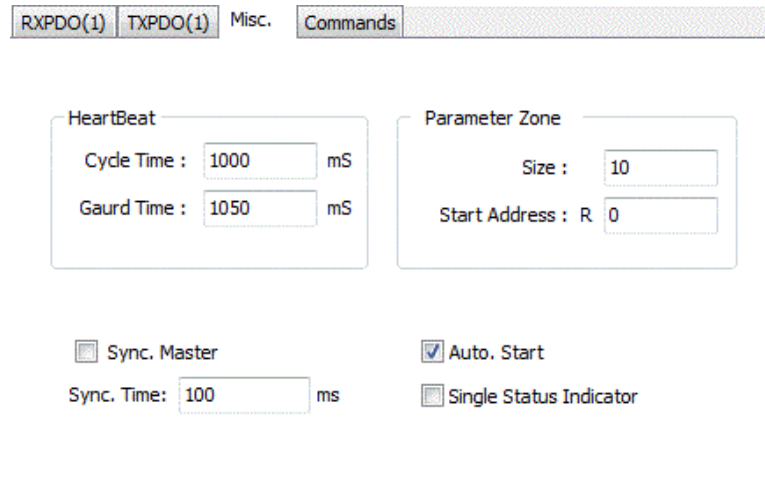

Figure 63: FBs-20MC Misc. Setting

If both 24MC and 20MC are configured properly, the PDOs transmission shall start automatically after system reboot. However, the data transmitted by PDOs are not DI status since both PLCs haven't been programmed to write their DI status to PDO transmission. Therefore, the last step is to make ladder programs which writes local DI status to pre-assigned registers (TXPDO1: R3600~R3603) for TXPDO transmission. For this demonstration, not only the transmitting site sends DI status out, but also receiving site needs to write the received data to its local output. To do this, ladder programs need to move the receiving data from pre-assigned registers (R3640~R3643) to its DO output.

Note. Since the number of local DI points of 24MC and 20MC is less than 16 points, only one register needed to be moved in both RXPDO and TXPDO cases. You can also find the hints to know which registers to be moved from the RXPDO and TXPDO configuration on the EasyCanOpener utility as shown on Figure 58 and Figure 59. The detailed ladder program is shown on Figure 64 below.

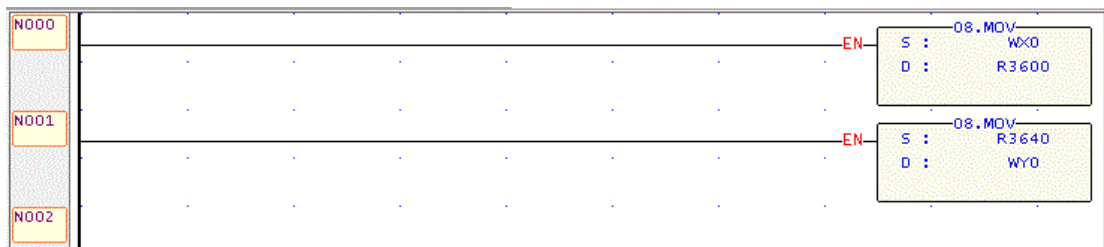

Figure 64: FBs-24MC and FBs-20MC Ladder Program

Appendix B

CBCAN Board Object Dictionary

. Communication Object

Index	SubIndex	Name	Data Type	Access	Default
1000H	0	Equipment Type	I32U	R	0
1001H	0	Error Register	I8U	R	0
1005H	0	COB-ID of SYNC	I32U	R	80H
100CH	0	Guard Time	I16U	R	0
100DH	0	Life Time Factor	I8U	R	0
1016H	Consumer Heartbeat Time				
	0	Item Count	I8U	R	1
	1	Consumer Heartbeat Time	I32U	R	1020
1017H	0	Producer Heartbeat Time	I32U	R	1000
1018H	Identity Object				
	0	Item Count	I8U	R	4
	1	Vendor code	I32U	R	2EFH
	2	Product Code	I32U	R	0
	3	Revision No.	I32U	R	0
	4	Serial No.	I32U	R	0
1400H	RXPDO1 Communication Parameters				
	0	Item Count	I8U	R	2
	1	RXPDO1 COB-ID	I32U	R	CFG
	2	Transmission type	I8U	R	0xff
1401H~ 1409H	RXPDO2~RXPDO10 Communication Parameters				
1600H	RXPDO1 Mapped Objects				
	0	Item Count	I8U	R	4
	1	RXPDO1 Mapped Object #1	I32U	R	CFG
	2	RXPDO1 Mapped Object #2	I32U	R	CFG
	3	RXPDO1 Mapped Object #3	I32U	R	CFG
	4	RXPDO1 Mapped Object #4	I32U	R	CFG
1601H~ 1609H	RXPDO2 ~ RXPDO10 Mapped Objects				

Communication Object (Cont.)

Index	SubIndex	Name	Data type	Access	Default
1800H	TXPDO1 Communication Parameters				
	0	Item Count	I8U	R	5
	1	TXPDO1 COB-ID	I32U	R	CFG
	2	TXPDO1 Transmission Type	I32U	R	0xff
	3	TXPDO1 Inhibit Time	I32U	R	CFG
	4	Reserved	-	-	-
	5	Event Time	I16U	R	CFG
1801H ~ 1809H	TXPDO2 ~ TXPDO10 Communication Parameters				
1A00H	TXPDO1 Mapped Objects				
	0	Item Count	I8U	R	4
	1	TXPDO1 Mapped Object #1	I32U	R	CFG
	2	TXPDO1 Mapped Object #2	I32U	R	CFG
	3	TXPDO1 Mapped Object #3	I32U	R	CFG
	4	TXPDO1 Mapped Object #4	I32U	R	CFG
1A01H ~ 1A09H	TXPDO2 ~ TXPDO10 Mapped Objects				

. PLC Parameter Zone Objects (Max. 1000 R register)

Index	SubIndex	Name	Date type	Access	Default
2000H	1	P Zone+0	WORD	RW	
2000H	2	P Zone+1	WORD	RW	
2000H	n	P Zone+n-1	.		
2000H	100	P Zone+99	WORD	RW	
2001H	1	P Zone+100	WORD	RW	
2001H	2	P Zone+101	WORD	RW	
~	~	~	WORD	RW	
2009H	100	P Zone+999	WORD	RW	

. PLC Process Data Objects

Index	SubIndex	Name	Data type	Access	Map
TXPDO process data					
2010H	1	R3600	116U	R	Yes
	2	R3601		R	
	3	R3602		R	
	4	R3603		R	
2011H ~ 2019H	R3604~R3639				
RXPDO process data					
201AH	1	R3640	116U	R	Yes
	2	R3641		R	
	3	R3642		R	
	4	R3642		R	
201BH ~ 2023H	R3640~R3679				

.Program Version Objects

Index	SubIndex	Name	Data type	Access	Default
4000H	0	Item Count	18U	R	2
	1	CBCAN Firmware version	132U	R	
	2	Ladder software version	132U	R	

Ladder software version is decided by R3697 of the PLC

. Electron board Version Objects

Index	SubIndex	Name	Data type	Access	Default
4001H	0	Item Count	18U	R	1
	1	Electron board version	132U	R	