



☎ :051-37133855-6

☎ :09014284236

WWW.ARCOKALA.COM

Operation **Manual**

SPC Series

Solar Pump Inverter



SHENZHEN INVT ELECTRIC CO., LTD.

No.	Change description	Version	Release date
1	First release	V1.0	November 2021

Contents

Contents	i
1 Safety precautions	1
1.1 Safety definition	1
1.2 Warning	1
1.3 Safety guidelines	2
1.3.1 Delivery and installation	2
1.3.2 Commissioning and running	3
1.3.3 Maintenance and component replacement	3
1.3.4 Disposal	4
2 Product overview	5
2.1 Unpacking inspection	5
2.2 Product nameplate	5
2.3 Model designation code	5
2.4 Product specifications	6
2.5 Product ratings	7
3 Installation guidelines	8
3.1 Mechanical installation environment	8
3.1.1 Installation environment	8
3.1.2 Installation direction	10
3.1.3 Installation method	10
3.2 Standard wiring	11
3.2.1 Main circuit terminals	11
3.2.2 Control circuit terminals	12
4 Keypad operation guidelines	13
4.1 Keypad introduction	13
4.2 Keypad display	15
4.2.1 Displaying stopped-state parameters	15
4.2.2 Displaying running-state parameters	15
4.2.3 Displaying fault information	15
4.2.4 Editing function codes	15
4.3 Operation procedure	16
4.3.1 Modifying function codes	16
4.3.2 Setting a password for the inverter	17
4.3.3 Viewing inverter status	17
5 Commissioning guidelines	18
5.1 Check before running	18
5.2 Trial run	18
5.3 Parameter settings	18

5.4 Advanced settings	18
5.4.1 Water discharge speed PI adjustment	18
6 Function parameter list.....	19
6.1 Function parameters related to control	19
P00 group Basic functions	19
P01 group Start and stop control	23
P02 group Parameters of motor 1	23
P04 group Space voltage vector control	25
P05 group Input terminals	28
P06 group Output terminals	29
P07 group Human-machine interface	30
P08 group Enhanced functions	34
6.2 Function parameters special for solar water pump	35
P11 group Protection.....	35
P13 group SM control	37
P14 group Serial communication	38
P15 group Functions special for solar inverter.....	40
P17 group Status viewing	47
P18 group Status viewing functions special for solar inverter	48
7 Fault diagnosis and solution.....	50
Appendix A Options	55
A.1 RMS and monitoring app	55
A.1.1 Product overview	55
A.1.2 Installation and delivery	56
A.2 Cable.....	56
A.2.1 Powe cable	56
A.2.2 Control cable	56
A.3 Reactor	57
Appendix B Recommended PV module configuration	59
B.1 PV module configuration recommended by inverter model	59
Appendix C Dimension drawings	60
C.1 External keypad structure	60
C.2 Dimensions of 2.2–7.5kW models	61
Appendix D Further information	62
D.1 Product and service queries	62
D.2 Feedback on INVT inverter manuals	62
D.3 Documents on the Internet	62

1 Safety precautions

Read this manual carefully and follow all safety precautions before moving, installing, operating and servicing SPC series solar pump inverter. Otherwise, equipment damage or physical injury or death may be caused.

We shall not be liable or responsible for any equipment damage or physical injury or death caused due to your or your customers' failure to follow the safety precautions.

If not otherwise specified, the inverter in this manual always indicates SPC series solar pump inverter.

1.1 Safety definition

Danger: Severe personal injury or even death can result if related requirements are not followed.









Warning: Personal injury or equipment damage can result if related requirements are not followed.

Note: Actions taken to ensure proper running.





Trained and qualified professionals: People operating the equipment must have received professional electrical and safety training and obtained the certificates, and must be familiar with all steps and requirements of equipment installing, commissioning, running and maintaining and capable to prevent any emergencies.

1.2 Warning


Warnings caution you about conditions that can result in severe injury or death and/or equipment damage and advice on how to prevent dangers. The following table lists the warning symbols in this manual.

Symbol	Name	Description	Abbreviation
 Danger	Danger	Severe personal injury or even death can result if related requirements are not followed.	
 Warning	Warning	Personal injury or equipment damage can result if related requirements are not followed.	
 Do not	Electrostatic sensitive	The PCBA may be damaged if related requirements are not followed.	
 Hot sides	Hot sides	Do not touch. The inverter base may become hot.	
Note	Note	Actions taken to ensure proper running.	Note

1.3 Safety guidelines

	<ul style="list-style-type: none"> Only trained and qualified professionals are allowed to carry out related operations. Do not perform wiring, inspection or component replacement when power supply is applied. Ensure all the input power supplies have been disconnected before wiring or inspection, and wait for at least the time designated on the inverter or until the DC bus voltage is less than 36V. The minimum waiting time is listed in the following. <table border="1" data-bbox="303 380 897 477"> <thead> <tr> <th colspan="2">Inverter model</th> <th>Minimum waiting time</th> </tr> </thead> <tbody> <tr> <td>220V</td> <td>2.2kW</td> <td>5 minutes</td> </tr> <tr> <td>380V</td> <td>4kW-7.5kW</td> <td>5 minutes</td> </tr> </tbody> </table>	Inverter model		Minimum waiting time	220V	2.2kW	5 minutes	380V	4kW-7.5kW	5 minutes
Inverter model		Minimum waiting time								
220V	2.2kW	5 minutes								
380V	4kW-7.5kW	5 minutes								
	<ul style="list-style-type: none"> Do not refit the inverter unless authorized; otherwise fire, electric shock or other injury may result. 									
	<ul style="list-style-type: none"> The base may become hot when the machine is running. Do not touch. Otherwise, you may get burnt. 									
	<ul style="list-style-type: none"> The electrical parts and components inside the inverter are electrostatic sensitive. Take measurements to prevent electrostatic discharge when performing related operations. 									

1.3.1 Delivery and installation

	<ul style="list-style-type: none"> Do not install the inverter on inflammables. In addition, prevent the inverter from contacting or adhering to inflammables. Do not run the inverter if it is damaged or incomplete. Do not contact the inverter with damp objects or body parts. Otherwise, electric shock may result.
---	--

- Select appropriate tools for inverter delivery and installation to ensure the safe and proper running and avoid physical injury or death. To ensure personal safety, take mechanical protective measures like wearing safety shoes and working uniforms.
- Do not carry the inverter only by its front cover as the cover may fall off.
- Protect the inverter against physical shock or vibration during delivery and installation.
- The installation site must be away from children and other public places.
- As inverter leakage current caused during running may exceed 3.5mA, ground properly and ensure the grounding resistance is less than 10Ω. The conductivity of PE grounding conductor is the same as that of the phase conductor (with the same

cross sectional area).

- (+) and (-) are the DC power input terminals, while U, V, and W are the output motor-connection terminals. Connect the input power and motor cables properly; otherwise, the inverter may be damaged.

1.3.2 Commissioning and running



- Cut off all power supplies connected to the inverter before terminal wiring, and wait for at least the time designated on the inverter after disconnecting the power supplies.
- High voltage presents inside the inverter during running. Do not carry out any operation on the inverter during running except for keypad setup.
- The inverter cannot be used as an "Emergency-stop device".
- The inverter cannot act as an emergency brake for the motor; it is a must to install a mechanical braking device.

- Do not switch on or switch off the input power supplies of the inverter frequently.
- If the inverter has been stored for a long time without being used, check the capacitors, perform capacitor reforming, and carry out pilot run for the inverter before the use.
- Close the inverter front cover before running; otherwise, electric shock may occur.



1.3.3 Maintenance and component replacement



- Only trained and qualified professionals are allowed to perform maintenance, inspection, and component replacement for the inverter.
- Cut off all power supplies connected to the inverter before terminal wiring, and wait for at least the time designated on the inverter after disconnecting the power supplies.
- During inverter maintenance and component replacement, take measures to prevent screws, cables and other conductive matters from falling into the internal of the inverter; in addition, take electrostatic discharge protection measures for the inverter and its internal components.

- Use proper torque to tighten screws.
- During maintenance and component replacement, keep the inverter and its parts and components away from combustible materials and ensure they have no combustible materials adhered.
- Do not carry out insulation voltage-endurance test on the inverter, or measure the control circuit of the inverter with a megohmmeter.

1.3.4 Disposal

	<ul style="list-style-type: none">• The inverter contains heavy metals. Dispose of a scrap inverter as industrial waste.
	<ul style="list-style-type: none">• When the life cycle ends, the inverter should enter the recycling system. Dispose of it separately at an appropriate collection point instead of placing it in the normal waste stream.



 :051-57133855-6

 :09014284236

WWW.ARCOKALIA.COM

2 Product overview

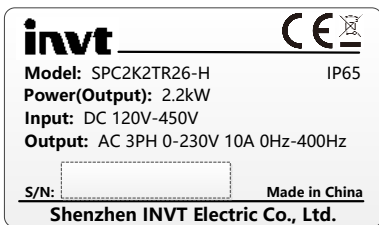
2.1 Unpacking inspection

Check the following after receiving the product.

1. Whether the packing box is damaged or dampened.
2. Whether the model identifier on the exterior surface of the packing box is consistent with the purchased model.
3. Whether the interior surface of the packing box is abnormal, for example, in wet condition, or whether the enclosure of the inverter is damaged or cracked.
4. Whether the inverter nameplate is consistent with the model identifier on the exterior surface of the packing box.
5. Whether the accessories (including the manual and keypad) inside the packing box are complete.

If any problems are found, contact the local INVT dealer or office.

2.2 Product nameplate



Note: The preceding shows a standard product nameplate example. The nameplate has markings such as "CE", "TUV", and "IP65" depending on the actual certification result.

2.3 Model designation code

A model designation code contains product information. You can find the model designation code on the inverter nameplate and simplified nameplate.

SPC 2K2 TR 2 6 - H

① ② ③ ④ ⑤ ⑥

Field	Symbol	Description	Content
SPC	①	Product series abbreviation	Abbreviation of solar pump controller
2K2	②	Rated power	The rated power is 2.2kW.
TR	③	Technical type	TR: 3PH
2	④	Output voltage class	2: 3PH 220V 4: 3PH 380V
6	⑤	Ingress protection (IP) rating	0: IP00 6: IP65
H	⑥	Configuration frame	IP65 model type. H: High performance S: Standard

2.4 Product specifications

Model	SPC2K2TR20 SPC2K2TR26-S SPC2K2TR26-H	SPC004TR40 SPC004TR46-S SPC004TR46-H	SPC7K5TR40 SPC7K5TR46-S SPC7K5TR46-H
Output power (kW)	2.2	4	7.5
DC input			
Max. DC input voltage (V)	450	800	800
Start voltage (V)	120	250	250
Min. working voltage (V)	70	200	200
Recommended DC input voltage range (V)	200–400	300–750	300–750
Recommended MPP voltage (V)	330	580	580
AC output			
Output voltage (V)	0–230	0–400	0–400
Output frequency (Hz)	0–400	0–400	0–400
Control performance			
Control mode	V/F (SVPWM), SVC		
Motor type	Asynchronous motor (AM) and synchronous motor (SM)		

Overload capacity	Able to run at 120% of the rated current for 1 minute and 150% of the rated current for 10 seconds
Other	
Ingress protection (IP) rating	IP65
Cooling method	Natural cooling
Human-machine interface (HMI)	External LED keypad

2.5 Product ratings

Model	Output power		Rated input current (A)	Rated output current (A)	Packing size W*H*D (mm)	Weight			
	(kW)	(HP)				Net weight		Gross weight	
						kg	lbs	kg	lbs
3PH 220V									
SPC2K2TR20	2.2	3	9	10	/	0.5	1.1	/	
SPC2K2TR26-S	2.2	3	9	10	302*380*190	2.5	5.5	3	6.6
SPC2K2TR26-H	2.2	3	9	10		2.5	5.5	3	6.6
3PH 380V									
SPC004TR40	4.0	5	9	9.5	/	0.6	1.3	/	
SPC7K5TR40	7.5	10	18	17	/	0.8	1.8	/	
SPC004TR46-S	4.0	5	9	9.5	302*380*190	2.5	5.5	3	6.6
SPC004TR46-H	4.0	5	9	9.5		2.5	5.5	3	6.6
SPC7K5TR46-S	7.5	10	18	17	340*400*260	3.6	7.9	4.4	9.7
SPC7K5TR46-H	7.5	10	18	17		3.6	7.9	4.4	9.7




 :051-37133855-6

 :09014284236

WWW.ARCOKALIA.COM

3 Installation guidelines

This chapter describes the mechanical installation and electrical installation of the inverter.

	<ul style="list-style-type: none"> Only trained and qualified professionals are allowed to carry out the operations mentioned in this chapter. Please carry out operations according to instructions presented in "Safety precautions". Ignoring these safety precautions may lead to physical injury or death, or device damage. Ensure the inverter power has been disconnected before installation. If the inverter has been powered on, disconnect the inverter from the power source, and wait for at least the time designated on the inverter. The inverter installation must be designed and done according to applicable local laws and regulations. INVT does not assume any liability whatsoever for any inverter installation which breaches local laws or regulations. If recommendations given by INVT are not followed, the inverter may experience problems that the warranty does not cover.
---	--

3.1 Mechanical installation environment

3.1.1 Installation environment

The installation environment is essential for the inverter to run at the best performance for a long time.

Environment	Condition
Installation site	Indoor/Outdoor
Ambient temperature	<ul style="list-style-type: none"> -25°C–60°C, and air temperature change shall be less than 0.5°C/minute. When the ambient temperature exceeds 45°C, the inverter must be derated by 1% for every increase of 1°C. It is not recommended to use the inverter when the ambient temperature exceeds 60°C. To improve reliability, do not use the inverter in the places where the temperature changes rapidly. When the inverter is used in a closed space, such as control cabinet, use a cooling fan or air conditioner for cooling, preventing the internal temperature from exceeding the temperature required. When the temperature is too low, if you want to use the inverter that

Environment	Condition
	has been idled for a long time, install an external heating device before the use to eliminate the freeze inside the inverter. Otherwise, the inverter may be damaged.
Relative humidity (RH)	Less than 95%
Storage temperature	-40°C–70°C, with the air temperature change rate less than 1°C/minute.
Running environment	<p>Install the inverter in a place:</p> <ul style="list-style-type: none"> ● Away from electromagnetic radiation sources; ● Away from oil mist, corrosive gases, and combustible gases ● Without the chance for foreign objects such as metal powder, dust, oil and water to fall into the inverter (do not install the inverter onto combustible objects such as wood) ● Without radioactive substances and combustible objects; ● Without hazard gases and liquids; ● With low salt content ● Without direct sunlight
Ingress protection (IP) rating	IP65
Altitude	<ul style="list-style-type: none"> ● When the altitude is higher than 2000m but lower than 3000m, derate the inverter by 1% for every increase of 100m. ● When the altitude is higher than 3000m but lower than 5000m, consult us for technical consulting. It is not recommended to use the inverter when the altitude exceeds 5000m.
Installation direction	Install the inverter vertically to ensure good heat dissipation performance.

Note:

- The inverter needs to be installed at a clean and ventilated environment according to the housing IP rating.
- The cooling air must be clean enough and free from corrosive gases and conductive dust.

3.1.2 Installation direction

The inverter can be installed on the wall or column or in a cabinet.

The inverter must be installed vertically. Check the installation position according to following requirements. For details about the outline dimensions, see Appendix C "Dimension drawings".

3.1.3 Installation method

The inverter supports column mounting.

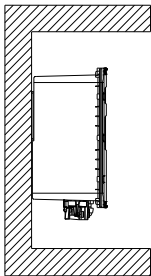


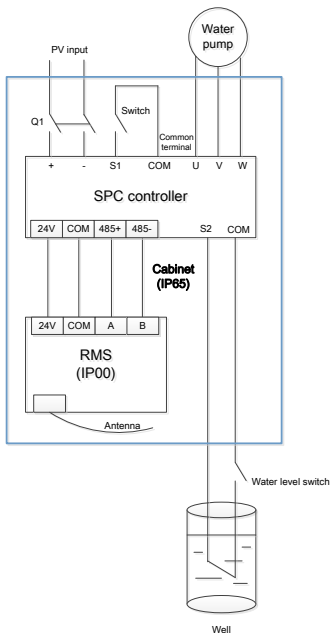
Figure 3-1 Column mounting

1. Mark the installation hole positions. For details about the installation hole positions, see Appendix C "Dimension drawings".
2. Mount the screws or bolts onto the designated positions.
3. Lean the inverter against the wall or column.
4. Tighten the fastening screws on the wall or column.


3.2 Standard wiring

3.2.1 Main circuit terminals

The inverter standard wiring is shown as follows.



- Use a convergence box special for a solar inverter when paralleling modules.
- It is recommended to select an optional output reactor when the water pump is more than 50m away from the inverter. For details about output reactor model selection, see section A.3 "Reactor".
- By default, the inverter runs automatically after being powered on. If you need to set parameters, see chapter 5 "Commissioning guidelines".

Terminal	Name	Description
PV+, PV-	PV DC input	PV module input terminals.
U, V, W	Inverter output	3PH AC output terminals, which connect to the water pump motor in most cases.
	Safety protection grounding	Grounding terminal for safe protection; each machine must be properly grounded.

3.2.2 Control circuit terminals

Category	Terminal	Name	Description
Power supply	24V	24V power supply	Used to externally provide 24V±10% power supply. Max. output current: 200mA
	COM	Common terminal	Generally used as the the working power supply of digital input/output or the external sensor power supply
S terminal control power supply	PW	S terminal switchover	When PW and 24V are short circuited, S terminals use the PNP connection method. When PW and COM are short circuited, S terminals use the NPN connection method.
Digital input	S1	Start/stop control	Terminal specifications: 1. Internal impedance: 3.3kΩ 2. 12–24V voltage input is acceptable 3. Max. input frequency: 1kHz
Communication	RS485+ RS485-	RS485 communication	RS485 communication terminals, using the Modbus protocol
Relay output	ROA	NO contact of relay 1	Contact capacity: 3A/AC250V, 1A/DC30V
	ROB	NC contact of relay 1	
	ROC	Common terminal of relay 1	

4 Keypad operation guidelines

4.1 Keypad introduction

The keypad is used to control the inverter, read inverter status, and set parameters. Use a standard RJ45 crystal-head network cable as the extension cable.

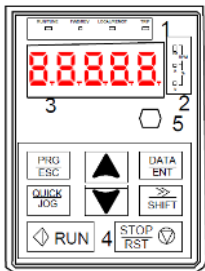
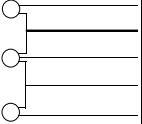










Figure 4-1 External keypad

No.	Name	Description
1	Status indicator	RUN/TUNE Inverter running status indicator. Off: The inverter is stopped. Blinking: The inverter is autotuning parameters. On: The inverter is running.
		FWD/REV Forward or reverse running indicator. Off: The inverter is running forward. On: The inverter is running reversely.
		LOCAL/REMOT Indicates whether the inverter is controlled through the keypad, terminals, or communication. Off: The inverter is controlled through the keypad. Blinking: The inverter is controlled through terminals. On: The inverter is controlled through remote communication.
		TRIP Fault indicator Off: in normal state

No.	Name	Description							
			Blinking: in pre-alarm state On: in fault state						
2	Unit indicator	Unit displayed currently							
			Hz RPM A % V	Frequency unit Rotation speed unit Current unit Percentage Voltage unit					
3	Digital display zone	Five-digit LED displays various monitoring data and alarm codes such as the frequency setting and output frequency.							
		Display	Means	Display	Means	Display	Means	Display	Means
		0	0	1	1	2	2	3	3
		4	4	5	5	6	6	7	7
		8	8	9	9	A	A	B	B
		C	C	D	D	E	E	F	F
		H	H	I	I	L	L	N	N
		n	n	o	o	P	P	r	r
		S	S	t	t	U	U	v	v
.	.	-	-						
4	Keys		Programming key	Press it to enter or exit level-1 menus or delete a parameter.					
			Confirmation key	Press it to enter menus in cascading mode or confirm the setting of a parameter.					
			Up key	Press it to increase data or move upward.					
			Down key	Press it to decrease data or move downward.					
			Right-shifting key	Press it to select display parameters rightward in the interface for the inverter in stopped or running state or to select digits to change during parameter setting.					
			Run key	Press it to run the inverter when using the keypad for control.					
			Stop/Reset key	Press it to stop the inverter that is running. The function of this key is restricted by P07.04 . In					


No.	Name	Description		
				fault alarm state, this key can be used for reset in any control modes.
			Multifunction shortcut key	The function of this key is determined by P07.02 .

4.2 Keypad display



The inverter keypad displays information such as the stopped-state parameters, running-state parameters, and fault status, and allows you to modify function codes.


4.2.1 Displaying stopped-state parameters

When the inverter is in stopped state, the keypad displays stopped-state parameters, as shown in Figure 4-2.



When the inverter is in stopped state, the keypad displays 4 stopped-state parameters, including set frequency, bus voltage, input terminal status, and output terminal status. You can press  to shift parameters.

4.2.2 Displaying running-state parameters

After receiving a valid running command, the inverter enters the running state, and the keypad displays running-state parameters, with the  indicator on. The on/off state of the  indicator is determined by the actual running direction, as shown in Figure 4-2.

In the running state, there are 6 parameters that can be displayed. There are: running frequency, set frequency, bus voltage, output voltage, output current, and rotational speed. You can press the  key to shift parameters.

4.2.3 Displaying fault information

After detecting a fault signal, the inverter enters the fault alarm state immediately, the fault code blinks on the keypad, and the  indicator is on. You can perform fault reset by using the  key, control terminals, or communication commands.

If the fault persists, the fault code is continuously displayed.

4.2.4 Editing function codes





You can press the  key to enter the editing mode in stopped, running, or fault alarm state (if a user password is used, see the description of P07.00). The editing mode contains two levels of menus in the following sequence: Function code group or function code number → Function code setting. You can press the  key to enter the function parameter display interface. In the function settings parameter display interface, you can press the  key to save parameter settings or press the  key to exit the parameter display interface.



Figure 4-2 Status display

4.3 Operation procedure

You can operate the inverter by using the keypad. For details about function code descriptions, see the function code list.

4.3.1 Modifying function codes

The inverter provides three levels of menus, including:

1. Function code group number (level-1 menu)
2. Function code number (level-2 menu)
3. Function code setting (level-3 menu)

Note: When performing operations on the level-3 menu, you can press the **PRG/ESC** or **DATA/ENT** key to return to the level-2 menu. If you press the **DATA/ENT** key, the set value of the parameter is saved to the control board first, and then the level-2 menu is returned, displaying the next function code. If you press the **PRG/ESC** key, the level-2 menu is returned directly, without saving the set value of the parameter, and the current function code is displayed.

If you enter the level-3 menu but the parameter does not have a digit blinking, the parameter cannot be modified due to either of the following reasons:

- It is read only. Read-only parameters include actual detection parameters and running record parameters.
- It cannot be modified in running state and can be modified only in stopped state.

Example: Change the value of **P00.01** from 0 to 1.

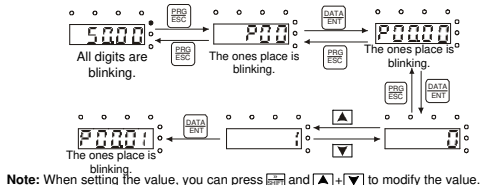


Figure 4-3 Modifying a parameter

4.3.2 Setting a password for the inverter

The inverter provides password protection function to users. Set P07.00 to gain the password and the password protection becomes effective 1 minute later after retreating from the function code editing state. Press **PRG/ESC** again to the function code editing state, "0.0.0.0.0" will be displayed. Unless using the correct password, you cannot enter it.

To disable the password protection function, you need only to set P07.00 to 0.

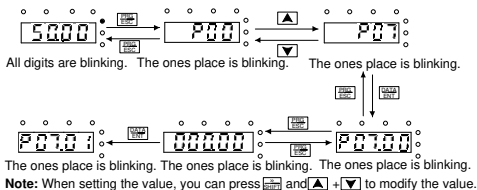


Figure 4-4 Setting a password

4.3.3 Viewing inverter status

The inverter provides groups P17 and P18 for status viewing. You can enter groups P17 and P18 for viewing.

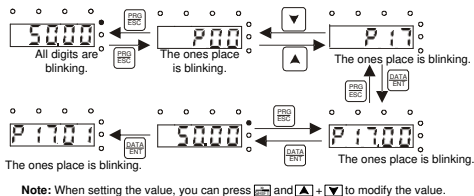


Figure 4-5 Viewing a parameter

5 Commissioning guidelines



- Cut off all power supplies connected to the inverter before terminal wiring, and wait for at least the time designated on the inverter after disconnecting the power supplies.
- High voltage presents inside the inverter during running. Do not carry out any operation on the inverter during running except for keypad setup.
- By default, the inverter runs automatically after being powered on. If you need to set parameters, comply with the procedure described in this chapter.

5.1 Check before running

Ensure the following before powering on the inverter:

1. The inverter has been grounded reliably.
2. The wire connection is correct and reliable.
3. The solar DC input voltage is within the range allowed by the inverter.
4. The motor type, voltage, and power match the inverter type, voltage, and power.

5.2 Trial run

Close the DC circuit breaker, observe the water output of the pump. If the water output is normal, the trial run is successful; if the water output is small, run again after swapping the connection of any two motor wires.

5.3 Parameter settings

By default, the inverter runs automatically after being powered on. To set parameters, do as follows: If the inverter has not been powered on, power on the inverter, and press **QUICK/JOG** to enter the keypad-based control mode (**LOCAL/REMOT** off). If the inverter has been powered on (Run indicator is on), press the **STOP/RST** key to enter the parameter setting interface. After the parameters are set, you can power off and on for a next run.

5.4 Advanced settings

Note: The default settings of the inverter can be adapted to most working conditions, and advanced settings are not required in most cases.

5.4.1 Water discharge speed PI adjustment

If you has higher requirements on the water discharge speed, you can adjust the PI parameters ([P15.06–P15.10](#)) appropriately. Setting the PI parameters to larger values will result in a faster water discharge speed, but the motor frequency fluctuates greatly; conversely, setting the PI parameters to smaller values will result in a slower water discharge speed, but the motor running frequency is relatively smooth.

6 Function parameter list

The function group numbers correspond to the level-1 menus, the function codes correspond to the level-2 menus, and the function parameters correspond to the level-3 menus.

The function code table contains:

Column 1 "Function code ": Code of the function group and parameter

Column 2 "Name": Full name of the function parameter

Column 3 "Description": Description of the function parameter. If the value is detected or recorded, the value cannot be restored to the factory setting.

Column 4 "Default": Initial value set in factory.

Column 5 "Modify": Whether the parameter can be modified, and conditions for the modification

"○" indicates that the value of the parameter can be modified when the inverter is in stopped or running state.

"⊙" indicates that the value of the parameter cannot be modified when the inverter is in running state.

"●" indicates that the value of the parameter is detected and recorded, and cannot be modified.

Note: The inverter automatically checks and constrains the modification of parameters, which helps prevent incorrect modifications.

6.1 Function parameters related to control

P00 group Basic functions

Function code	Name	Description	Default	Modify
P00.00	Speed control mode	0: SVC mode 0 No need to install encoders. Applicable to scenarios with requirements for low frequency, great torque, and high speed control accuracy. Relative to SVC mode 1, SVC mode 0 is more applicable to the scenarios requiring small power. 1: SVC mode 1 Applicable to high-performance scenarios, featuring high rotation and	2	⊙

Function code	Name	Description	Default	Modify
		torque accuracy, without the need to install pulse encoders. 2: Space voltage vector control mode Applicable to scenarios without demanding requirements on control accuracy, such as fan and pump. One inverter can drive multiple motors.		
P00.01	Channel of running commands	Used to select the channel of running inverter control commands. The inverter control commands include the start, stop, forward run, reverse run, and fault reset commands. 0: Keypad (LOCAL/REMOT off) The commands are controlled through keypad keys, such as the RUN and STOP/RST keys. In running state, you can press both RUN and STOP/RST to enable the inverter to coast to stop. 1: Terminal (LOCAL/REMOT blinking) The running commands are controlled through multifunction input terminals. 2: Communication (LOCAL/REMOT on) The running commands are controlled by the upper computer in communication mode.	1	<input type="radio"/>
P00.03	Max. output frequency	Used to set the max. output frequency of the inverter. Pay attention to the function code because it is the foundation of the frequency setting and the speed of acceleration (ACC) and deceleration (DEC). Setting range: P00.04 –400.00Hz	110.00Hz	<input checked="" type="radio"/>
P00.04	Upper limit of running frequency	The upper limit of the running frequency is the upper limit of the output frequency of the inverter, which is lower than or equal to the max. output frequency. When the set frequency is higher than	110.00Hz	<input checked="" type="radio"/>

Function code	Name	Description	Default	Modify
		the upper limit of the running frequency, the upper limit of the running frequency is used for running. Setting range: P00.05 – P00.03 (Max. output frequency)		
P00.05	Lower limit of running frequency	The lower limit of the running frequency is the lower limit of the output frequency of the inverter, When the set frequency is lower than the lower limit of the running frequency, the lower limit of the running frequency is used for running. Note: Max. output frequency \geq Upper limit of frequency \geq Lower limit of frequency Setting range: 0.00Hz– P00.04 (Upper limit of running frequency)	0.00Hz	⊙
P00.06	Setting channel of A frequency command	0: Keypad 1–7: Reserved 8: Modbus communication Setting range: 0–8	0	○
P00.10	Frequency set through keypad	0.00 Hz– P00.03 (Max. output frequency)	110.00Hz	○
P00.11	ACC time 1	ACC time means the time needed if the inverter speeds up from 0Hz to the max. output frequency (P00.03).	Model depended	○
P00.12	DEC time 1	DEC time means the time needed if the inverter speeds down from the max. output frequency (P00.03) to 0Hz. Setting range of P00.11 and P00.12 : 0.0–3600.0s	Model depended	○
P00.13	Running direction	0: Run at the default direction. The inverter runs in forward direction. (FWD/REV off) 1: Run at the opposite direction. The inverter runs in reverse direction. (FWD/REV on)	0	○

Function code	Name	Description	Default	Modify
		<p>Note:</p> <ul style="list-style-type: none"> When the parameter is restored to the default value, the motor's running direction is restored to the default one. Exercise caution before using this function if the change of motor rotation direction is disallowed after commissioning. Do not change the setting of the parameter because reverse running is not allowed in water pump application scenarios. <p>2: Disable reverse running. It can be used in some special scenarios where reverse running is disallowed.</p>		
P00.15	Motor parameter autotuning	<p>0: No operation 1: Rotary autotuning Comprehensive motor parameter autotuning. It is recommended to use rotating autotuning when high control accuracy is needed. 2: Static autotuning 1 Used in scenarios where the motor cannot be disconnected from load. 3: Static autotuning 2 Empty-load current and mutual inductance are not autotuned.</p>	0	⊙
P00.18	Function parameter restore	<p>0: No operation 1: Restore default values 2: Clear fault records</p> <p>Note:</p> <ul style="list-style-type: none"> After the selected operation is performed, the function code is automatically restored to 0. Restoring the default values may delete the user password. Exercise caution before using this function. 	0	⊙

P01 group Start and stop control

Function code	Name	Description	Default	Modify
P01.08	Stop mode	0: Decelerate to stop. When a stop command takes effect, the inverter lowers output frequency based on the DEC mode and the defined DEC time; when the frequency drops to 0Hz, the inverter stops. 1: Coast to stop. When a stop command takes effect, the inverter stops output immediately. and the load coasts to stop according to mechanical inertia.	0	<input type="radio"/>
P01.18	Terminal-based running command protection at power-on	0: The terminal running command is invalid at power-on 1: The terminal running command is valid at power-on	1	<input type="radio"/>
P01.21	Power-off restart selection	0: Disable restart 1: Enable restart	1	<input type="radio"/>

P02 group Parameters of motor 1

Function code	Name	Description	Default	Modify
P02.00	Motor type	0: Asynchronous motor (AM) 1: Synchronous motor (SM)	1	<input checked="" type="radio"/>
P02.01	Rated power of AM	0.1–3000.0kW	Model depended	<input checked="" type="radio"/>
P02.02	Rated frequency of AM	0.01Hz–P00.03		110.00Hz

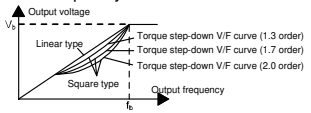
Used to set AM parameters. To ensure the control performance, set [P02.01–P02.05](#) correctly according to the information on the nameplate of the AM. The inverter provides

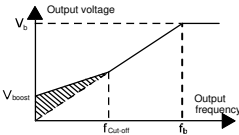
Function code	Name	Description		Default	Modify
P02.03	Rated speed of AM	1–36000rpm	the parameter autotuning function. Whether parameter autotuning can be performed properly depends on the settings of the motor nameplate parameters. In addition, you need to configure a motor according to the standard motor configuration of the inverter. If the power of the motor is greatly different from that of the standard motor configuration, the control performance of the inverter degrades significantly. Note: Resetting the rated power of the motor (P02.01) can initialize the parameters P02.02–P02.10 .	Model depended	☉
P02.04	Rated voltage of AM	0–1200V		Model depended	☉
P02.05	Rated current of AM	0.8–6000.0A		Model depended	☉
P02.06	Stator resistance of AM	0.001–65.535Ω	After motor parameter autotuning is properly performed, the values of P02.06–P02.10 are automatically updated. These parameters are the benchmark parameters for high-performance vector control, directly affecting the control	Model depended	○
P02.07	Rotor resistance of AM	0.001–65.535Ω		Model depended	○
P02.08	Leakage inductance of AM	0.1–6553.5mH		Model depended	○
P02.09	Mutual inductance of AM	0.1–6553.5mH		Model depended	○

Function code	Name	Description		Default	Modify
P02.10	No-load current of AM	0.1–6553.5A	performance. Note: Do not modify these parameters unless it is necessary.	Model depended	<input type="radio"/>
P02.15	Rated power of SM	0.1–3000.0kW	0.1–3000.0	Model depended	<input checked="" type="radio"/>
P02.16	Rated frequency of SM	0.01Hz–P00.03 (Max. output frequency)	0.01–P00.03	110.00Hz	<input checked="" type="radio"/>
P02.17	Number of pole pairs of SM	1–128	1–128	2	<input checked="" type="radio"/>
P02.18	Rated voltage of SM	0–1200V	0–1200	Model depended	<input checked="" type="radio"/>
P02.19	Rated current of SM	0.8–6000.0A	0.8–6000.0	Model depended	<input checked="" type="radio"/>
P02.20	Stator resistance of SM	0.001–65.535Ω	0.001–65.535	Model depended	<input type="radio"/>
P02.21	Direct-axis inductance of SM	0.01–655.35Mh	0.01–655.35	Model depended	<input type="radio"/>
P02.22	Quadrature-axis inductance of SM	0.01–655.35Mh	0.01–655.35	Model depended	<input type="radio"/>
P02.23	Counter-emf of SM	0–10000	0–10000	300	<input type="radio"/>

P04 group Space voltage vector control

Function code	Name	Description	Default	Modify
P04.00	V/F curve setting	This group of function code defines the V/F curve of motor 1 to meet the needs of different loads. 0: Straight-line V/F curve, applicable to constant torque loads 1: Reserved	0	<input checked="" type="radio"/>

Function code	Name	Description	Default	Modify
		<p>2: Torque-down V/F curve (power of 1.3) 3: Torque-down V/F curve (power of 1.7) 4: Torque-down V/F curve (power of 2.0) Curves 2 – 4 are applicable to the torque loads such as fans and water pumps. You can adjust according to the characteristics of the loads to achieve best performance.</p> <p>5: Customized V/F (V/F separation); in this mode, V can be separated from F and F can be adjusted through the frequency setting channel set by P00.06 or the voltage setting channel set by P04.27 to change the characteristics of the curve.</p> <p>Note: In the following figure, V_b is the motor rated voltage and f_b is the motor rated frequency.</p> 		
P04.01	Torque boost	In order to compensate for low-frequency torque characteristics, you can make some boost compensation for the output voltage. P04.01 is relative to the max. output voltage V_b .	2.0%	<input type="radio"/>
P04.02	Torque boost cut-off	<p>P04.02 defines the percentage of cut-off frequency of manual torque boost to the rated motor frequency f_b. Torque boost can improve the low-frequency torque characteristics in space voltage vector control mode.</p> <p>You need to select torque boost based on the load. For example, larger load requires larger torque boost, however, if the torque boost is too large, the motor</p>	20.0%	<input type="radio"/>

Function code	Name	Description	Default	Modify
		<p>will run at over-excitation, which may cause increased output current and motor overheating, thus decreasing the efficiency.</p> <p>When torque boost is set to 0.0%, the inverter uses automatic torque boost.</p> <p>Torque boost cut-off threshold: Below this frequency threshold, torque boost is valid; exceeding this threshold will invalidate torque boost.</p>  <p>Setting range of P04.01: 0.0%–10.0% Setting range of P04.02: 0.0%–50.0%</p>		
P04.09	V/F slip compensation gain	<p>The function code is used to compensate for the motor rotating speed change caused by load change in the space voltage vector mode, and thus improve the rigidity of the mechanical characteristics of the motor. You need to calculate the rated slip frequency of the motor as follows:</p> $\Delta f = f_b - n \cdot p / 60$ <p>Of which, f_b is the rated frequency of the motor, corresponding to function code P02.01. n is the rated rotating speed of the motor, corresponding to function code P02.02. p is the number of pole pairs of the motor. 100.0% corresponds to the rated slip frequency Δf of the motor.</p> <p>Setting range: 0.0–200.0%</p>	100.0%	<input type="radio"/>

Function code	Name	Description	Default	Modify
P04.10	Low-frequency oscillation control factor of motor 1	In space voltage vector control mode, the motor, especially the large-power motor, may experience current oscillation at certain frequencies, which may cause	10	<input type="radio"/>
P04.11	High-frequency oscillation control factor of motor 1	unstable motor running, or even inverter overcurrent. You can adjust the two function codes properly to eliminate such phenomenon.	10	<input type="radio"/>
P04.12	Oscillation control threshold	Setting range of P04.10 and P04.11: 0–100 Setting range of P04.12: 0.00Hz–P00.03 (Max. output frequency)	30.00Hz	<input type="radio"/>
P04.36	Reactive closed-loop KP	0–5000	50	<input type="radio"/>
P04.37	Reactive closed-loop KI	0–5000	50	<input type="radio"/>

P05 group Input terminals

Function code	Name	Description	Default	Modify
P05.01	Function of S1	0: No function 1: Run forward 2: Run reversely 3: Reserved 4: Jog forward 5: Jog reversely 6: Coast to stop 7: Reset faults 8: Pause running 9: External fault input 10–29: Reserved 30: Disable ACC/DEC 31–33: Reserved 34: DC braking 35: Reserved 36: Switch the running command channel to keypad	1	<input checked="" type="radio"/>

Function code	Name	Description	Default	Modify		
		37: Switch the running command channel to terminal 38: Switch the running command channel to communication 39: Pre-exciting command 40–42: Reserved 43: Full-water signal 44: Empty-water signal 45–63: Reserved				
P05.10	Input terminal polarity	The function code is used to set the polarity of input terminals. When a bit is 0, the input terminal is positive; When a bit is 1, the input terminal is negative. <div style="text-align: center;"> <table border="1" style="margin: 0 auto;"> <tr> <td>BIT0</td> </tr> <tr> <td>S1</td> </tr> </table> </div> Setting range: 0x0–0xF	BIT0	S1	0x0	⊙
BIT0						
S1						

P06 group Output terminals

Function code	Name	Description	Default	Modify
P06.03	RO output	0: Disable 1: Running 2: Running forward 3: Running reversely 4: Jogging 5: Inverter in fault 8: Frequency reached 9: Running in zero speed 10: Upper limit frequency reached 11: Lower limit frequency reached 12: Ready for running 13: Pre-exciting 14: Overload pre-alarm 15: Underload pre-alarm	1	○

Function code	Name	Description	Default	Modify		
		16–19: Reserved 20: External fault is valid 21: Reserved 22: Running time reached 23: Modbus communication virtual terminal output 26: DC bus voltage established 27: Weak light 28: Underload 29: Full water 30: Empty water				
P06.05	Output terminal polarity selection	The function code is used to set the polarity of output terminals. When a bit is 0, the output terminal is positive; when a bit is 1, the output terminal is negative. <table border="1" data-bbox="508 666 651 748"> <tr> <td>BIT0</td> </tr> <tr> <td>RO1</td> </tr> </table> Setting range: 0x0–0xF	BIT0	RO1	0x0	<input type="radio"/>
BIT0						
RO1						
P06.10	RO switch-on delay	0.000–50.000s	10.000s	<input type="radio"/>		
P06.11	RO switch-off delay	0.000–50.000s	10.000s	<input type="radio"/>		

P07 group Human-machine interface

Function code	Name	Description	Default	Modify
P07.00	User password	0–65535 When you set the function code to a non-zero number, password protection is enabled. If you set the function code to 00000, the previous user password is cleared and password protection is disabled. After the user password is set and takes effect, you cannot enter the parameter	0	<input type="radio"/>

Function code	Name	Description	Default	Modify
		<p>menu if you enter an incorrect password. Please remember your password and save it in a secure place.</p> <p>After you exit the function code editing interface, the password protection function is enabled within 1 minute. If password protection is enabled, "0.0.0.0" is displayed when you press the PRG/ESC key again to enter the function code editing interface. You need to enter the correct user password to enter the interface.</p> <p>Note: Restoring the default values may delete the user password. Exercise caution before using this function.</p>		
P07.01	Parameter copy	<p>Used to set the parameter copy mode.</p> <p>0: No operation</p> <p>1: Upload parameters from the local address to the keypad</p> <p>2: Download parameters (including motor parameters) from the keypad to the local address</p> <p>3: Download parameters (excluding group P02) from the keypad to the local address</p> <p>4: Download parameters (only including group P02) from the keypad to the local address</p> <p>Note: After any operation among 1–4 is complete, the parameter restores to 0. The upload and download functions are not applicable to group P29.</p>	0	⊙
P07.02	Function of QUICK/JOG	<p>Ones place: Function of QUICK/JOG</p> <p>0: No function</p> <p>1–5: Reserved</p> <p>6: Switch command channels in sequence</p>	6	⊙

Function code	Name	Description	Default	Modify
		Tens place: Reserved		
P07.03	Sequence of switching running-comm and channels by pressing QUICK/JOG	When P07.02 =6, set the sequence of switching running-command channels by pressing this key. 0: Keypad→Terminal→Communication 1: Keypad←→Terminal 2: Keypad←→Communication 3: Terminal←→Communication	1	○
P07.04	Stop function validity of STOP/RST	Used to specify the stop function validity of STOP/RST . For fault reset, STOP/RST is valid in any conditions. 0: Valid only for keypad control 1: Valid both for keypad and terminal control 2: Valid both for keypad and communication control 3: Valid for all control modes	3	○
P07.12	Inverter temperature	0–100.0°C		●
P07.13	Control board software version	1.00–655.35		●
P07.21	Factory bar code 1	0x0000–0xFFFF		●
P07.22	Factory bar code 2	0x0000–0xFFFF		●
P07.23	Factory bar code 3	0x0000–0xFFFF		●
P07.24	Factory bar code 4	0x0000–0xFFFF		●
P07.25	Factory bar code 5	0x0000–0xFFFF		●
P07.27	Present fault type	0: No fault 1–3: Reserved		●
P07.28	Last fault type	4: Overcurrent during acceleration (OC1)		●
P07.29	2nd-last fault type	5: Overcurrent during deceleration (OC2) 6: Overcurrent during constant speed		●

Function code	Name	Description	Default	Modify
P07.30	3rd-last fault type	running (OC3) 7: Overvoltage during acceleration (OV1)		●
P07.31	4th-last fault type	8: Overvoltage during deceleration (OV2) 9: Overvoltage during constant speed		●
P07.32	5th-last fault type	running (OV3) 10: Bus undervoltage fault (UV)		●
P07.57	6th-last fault type	11: Motor overload (OL1) 12: Inverter overload (OL2)		●
P07.58	7th-last fault type	13: Reserved 14: Phase loss on output side (SPO)		●
P07.59	8th-last fault type	15: Reserved 16: Inverter module overheat (OH2)		●
P07.60	9th-last fault type	17: External fault (EF) 18: RS485 communication fault (CE)		●
P07.61	10th-last fault type	19: Current detection fault (ItE) 20: Motor autotuning fault (tE)		●
P07.62	11th-last fault type	21: EEPROM operation error (EEP) 22–23: Reserved		●
P07.63	12th-last fault type	24: Running time reached (END) 25: Electronic overload (OL3) 26–31: Reserved		●
P07.64	13th-last fault type	32: To-ground short-circuit fault 1 (ETH1)		●
P07.65	14th-last fault type	33: To-ground short-circuit fault 2 (ETH2)		●
P07.66	15th-last fault type	34: Speed deviation fault (dEu) 35: Mal-adjustment fault (STo)		●
P07.67	16th-last fault type	36: Underload fault (LL) 37–43: Reserved		●
P07.68	17th-last fault type	Alarm: 44: Light-weak pre-alarm (A-LS) 45: Underload pre-alarm (A-LL)		●
P07.69	18th-last fault type	46: Full-water pre-alarm (A-tF) 47: Empty-water pre-alarm (A-tL)		●
P07.70	19th-last fault type			●
P07.71	20th-last fault type			●

P08 group Enhanced functions

Function code	Name	Description	Default	Modify
P08.28	Auto fault reset count	Setting range: 0–10 The following faults can be automatically reset: OC1: Overcurrent during acceleration OC2: Overcurrent during deceleration OC3: Overcurrent during constant speed running OV1: Overvoltage during acceleration OV2: Overvoltage during deceleration OV3: Overvoltage during constant speed running UV: Bus undervoltage fault OL1: Motor overload OL2: Inverter overload SPO: Phase loss on output side EF: External fault CE: RS485 communication fault ItE: Current detection fault tE: Motor autotuning fault EEP: EEPROM operation error END: Running time reached OL3: Electronic overload ETH1: To-ground short-circuit fault 1 ETH2: To-ground short-circuit fault 2 dEu: Speed deviation fault STo: Mal-adjustment fault LL: Underload fault	5	○
P08.29	Auto fault reset interval	0.1–3600.0s	10.0s	○

6.2 Function parameters special for solar water pump

P11 group Protection

Function code	Name	Description	Default	Modify
P11.01	Frequency decrease at sudden power loss	0: Disable 1: Enable	0	<input type="radio"/>
P11.02	Frequency decrease ratio at sudden power loss	0.00Hz– P00.03 /s If the bus voltage drops to the sudden frequency decreasing point due to the power loss of the grid, the inverter begins to decrease the running frequency according to P11.02 to make the motor in power generation state. The regenerative power can maintain the bus voltage to ensure normal running of the inverter until the recovery of power.	10.00Hz/s	<input type="radio"/>
P11.05	Current limit selection	0x00–0x12 Ones place: Current limit action selection 0: Invalid 1: Valid 2: Invalid during DEC Tens: Hardware current limit overload alarm selection 0: Valid 1: Invalid	0x01	<input checked="" type="radio"/>
P11.06	Automatic current limit threshold	50.0–200.0%	120.0%	<input checked="" type="radio"/>
P11.07	Frequency decrease ratio in current limiting	0.00–50.00Hz/s	10.00Hz/s	<input checked="" type="radio"/>
P11.08	Inverter/motor OL/UL pre-alarm selection	0x0000–0x1131 Ones place: 0: Motor OL/UL pre-alarm, relative to the motor rated current	0x0000	<input type="radio"/>

Function code	Name	Description	Default	Modify
		1: Inverter OL/UL pre-alarm, relative to the inverter rated current Tens place: 0: The inverter continues to work for an OL/UL alarm. 1: The inverter continues to work for a UL alarm but stops running for an OL fault. 2: The inverter continues to work for an OL alarm but stops running for a UL fault. 3. The inverter stops running for an OL/UL alarm. Hundreds place: 0: Detect all the time. 1: Detect during constant speed running. Thousands place: Overload integral function selection 0: Reserved 1: Reserved		
P11.09	Underload pre-alarm detection threshold	P11.11–200%	120%	<input type="radio"/>
P11.10	Overload pre-alarm detection time	0.1–3600.0s	1.0s	<input type="radio"/>
P11.11	Underload pre-alarm detection threshold	0%–P11.09	50%	<input type="radio"/>
P11.12	Underload pre-alarm detection time	0.1–3600.0s	1.0s	<input type="radio"/>
P11.13	Fault output terminal action selection at a fault	0x00–0x11 Ones place: 0: Act upon an undervoltage fault 1: Do not act upon an undervoltage fault Tens place:	0x00	<input type="radio"/>

Function code	Name	Description	Default	Modify
		0: Act during the automatic reset period 1: Do not act during the automatic reset period		
P11.14	Speed deviation detection value	0.0–50.0%	10.0%	<input type="radio"/>
P11.15	Speed deviation detection time	0.0–10.0s (No speed deviation protection for the value=0.0)	0.5s	<input type="radio"/>

P13 group SM control

Function code	Name	Description	Default	Modify
P13.00	SM injected-current decrease ratio	0.0%–100.0% (of the motor rated current)	80.0%	<input type="radio"/>
P13.01	Initial pole detection method	0: Source current 1: High frequency superimposition (reserved) 2: Pulse superimposition (reserved)	0	<input checked="" type="radio"/>
P13.02	Injected current 1	-100.0%–100.0% (of the motor rated current)	20.0%	<input type="radio"/>
P13.03	Injected current 2	-100.0%–100.0% (of the motor rated current)	20.0%	<input type="radio"/>
P13.04	Source-current switchover frequency	0.00Hz–P00.03 (Max. output frequency)	10.00Hz	<input type="radio"/>
P13.06	High frequency superimposed voltage	0.0–300.0% (of the motor rated voltage)	100.0%	<input checked="" type="radio"/>
P13.11	Mal-adjustment detection time	0.0–10.0s	0.5s	<input type="radio"/>
P13.12	SM high-frequency compensation coefficient	0.0–100.0%	0.0	<input type="radio"/>

P14 group Serial communication

Function code	Name	Description	Default	Modify
P14.00	Local communication address	1-247	1	<input type="radio"/>
P14.01	Communication baud rate	0: 1200BPS 1: 2400BPS 2: 4800BPS 3: 9600BPS 4: 19200BPS 5: 38400BPS 6: 57600BPS	3	<input type="radio"/>
P14.02	Data bit check	0: No check (N, 8, 1) for RTU 1: Even check (E, 8, 1) for RTU 2: Odd check (O, 8, 1) for RTU 3: No check (N, 8, 2) for RTU 4: Even check (E, 8, 2) for RTU 5: Odd check (O, 8, 2) for RTU	1	<input type="radio"/>
P14.03	Communication response delay	0-200ms	5	<input type="radio"/>
P14.04	Communication timeout time	0.0 (invalid); 0.1-60.0s	0.0s	<input type="radio"/>
P14.05	Transmission fault processing	0: Report an alarm and coast to stop 1: Keep running without reporting an alarm 2: Stop in enabled stop mode without reporting an alarm (applicable only to communication mode) 3: Stop in enabled stop mode without reporting an alarm (applicable to any mode)	0	<input type="radio"/>
P14.06	Communication processing action	0x000-0x111 Ones place: 0: Respond to write operations 1: Not respond to write operations Tens place: 0: Password protection is invalid.	0x000	<input type="radio"/>

Function code	Name	Description	Default	Modify
		<p>1: Password protection is valid. Hundreds place: User-defined communication command address 0: Invalid 1: Valid</p> <p>The hundreds place of P14.06 is used to define whether a user-defined address is valid. The value 0 indicates the standard communication mode is used, while the value 1 indicates a user-defined communication address is supported. A user-defined communication address takes priority. Supported user-defined addresses are P14.07 (Run command) and P14.08 (Frequency giving). You can set the address according to the type of inverter that will be replaced.</p>		
P14.07	User-defined address for running commands	0x0000–0xFFFF	0x1000	<input type="radio"/>
P14.08	User-defined address for frequency setting	0x0000–0xFFFF	0x2000	<input type="radio"/>
P14.10	Enabling upgrade	<p>0: Disable 1: Enable</p> <p>Only when this parameter is set to 1 (Enable), P14.01 is automatically updated to 6, and the RMS module can upgrade the firmware.</p> <p>Note: Firmware upgrade requires that the machine is not in running state.</p>	0	<input checked="" type="radio"/>
P14.11	Boot software version	1.00–9.99		<input checked="" type="radio"/>

P15 group Functions special for solar inverter

Function code	Name	Description	Default	Modify						
P15.00	Solar inverter selection	0: Disable 1: Enable The value 0 indicates solar control is invalid, and this function group is not used. The value 1 indicates solar control is valid, this function group can be modified.	1	⊙						
P15.01	Vmpp voltage giving method	0: Voltage 1: Max. power tracking The value 0 indicates using the voltage giving method, the reference voltage is P15.02 , and it is a fixed value. The value 1 indicates the reference voltage is given by tracking the max. power. The reference voltage keeps changing until the system becomes stable. Note: This parameter is invalid when terminal function 43 is valid.	1	⊙						
P15.02	Vmpp voltage given through keypad	0.0–6553.5Vdc When P15.01 is 0, this parameter determines the reference voltage. (During testing, the reference voltage value must be less than the PV input voltage. Otherwise, the system runs at the lower limit of frequency.) The default value depends on the model: <table border="1" data-bbox="381 1059 778 1195"> <thead> <tr> <th>Model</th> <th>Vmpp voltage set through keypad</th> </tr> </thead> <tbody> <tr> <td>2.2kW</td> <td>250.0V</td> </tr> <tr> <td>4–7.5kW</td> <td>450.0V</td> </tr> </tbody> </table>	Model	Vmpp voltage set through keypad	2.2kW	250.0V	4–7.5kW	450.0V	Model depended	○
Model	Vmpp voltage set through keypad									
2.2kW	250.0V									
4–7.5kW	450.0V									
P15.03	PID control deviation limit	0.0–100.0% (100.0% corresponding to P15.02) PI adjustment is performed only when the ratio of the difference between the actual	0.0%	○						

Function code	Name	Description	Default	Modify
		voltage and reference voltage to the reference voltage, which is $\text{abs}(\text{Actual voltage} - \text{Reference voltage}) * 100.0\% / (\text{Reference voltage})$, exceeds P15.03 . The default value is 0.0%. abs: The absolute value is used.		
P15.04	PID output upper limit frequency	P15.05 –100.0% (100.0% corresponding to P00.03) P15.04 is used to limit the max. value of target frequency. 100.0% corresponds to P00.03 . After PI adjustment, the target frequency cannot exceed the upper limit.	100.0%	<input type="radio"/>
P15.05	PID output lower limit frequency	0.0%– P15.04 (100.0% corresponding to P00.03) P15.05 is used to limit the min. value of target frequency. 100.0% corresponds to P00.03 . After PI adjustment, the target frequency cannot be less than the lower limit.	20.0%	<input type="radio"/>
P15.06	KP1	0.00–100.00 Proportional coefficient 1 of target frequency A greater value indicates stronger effect and faster adjustment.	5.00	<input type="radio"/>
P15.07	KI1	0.00–100.00 Integral coefficient 1 of target frequency A greater value indicates stronger effect and faster adjustment.	5.00	<input type="radio"/>
P15.08	KP2	0.00–100.00 Proportional coefficient 2 of target frequency A greater value indicates stronger effect and faster adjustment.	35.00	<input type="radio"/>
P15.09	KI2	0.00–100.00 Integral coefficient 2 of target frequency A greater value indicates stronger effect	35.00	<input type="radio"/>

Function code	Name	Description	Default	Modify
		and faster adjustment.		
P15.10	PI switchover point	0.0–6553.5Vdc When the absolute value of PV voltage minus reference voltage is greater than P15.10 , P15.08 and P15.09 are used. Otherwise, P15.06 and P15.07 are used.	20.0V	☉
P15.11	Water level control selection	0: Control through digital input 1–2: Reserved The value 0 indicates the water level signal is controlled through digital input. For details, see S terminal functions 43 and 44 of P05. When the terminal input of full-water signal is valid, the system reports the full-water pre-alarm (A-tF) with a delay specified by P15.14 and then sleeps. In full-water alarm state, the full-water signal is invalid, the system clears the full-water alarm with a delay specified by P15.15 and then re-enters the running state. When the terminal input of empty-water signal is valid, the system reports the empty-water pre-alarm (A-tL) with a delay specified by P15.16 and then sleeps. In empty-water alarm state, the empty-water signal is invalid, the system clears the empty-water alarm with a delay specified by P15.17 and then re-enters the running state.	0	☉
P15.14	Full-water level delay	0–10000s Time setting on full-water level delay. (This parameter is still valid for digital full-water signal.)	5s	○
P15.15	Full-water level wake-up delay	0–10000s Time setting on full-water level wake-up delay. (This parameter is still valid for digital full-water signal.)	20s	○

Function code	Name	Description	Default	Modify
P15.16	Empty-water level delay	0–10000s Time setting on empty-water level delay. (This parameter is still valid for digital empty-water signal.)	5s	<input type="radio"/>
P15.17	Empty-water level wake-up delay	0–10000s Time setting on empty-water level wake-up delay. (This parameter is still valid for digital empty-water signal.)	20s	<input type="radio"/>
P15.19	Water pump run time in underload state	0.0–1000.0s Duration in which the water pump runs in underload state. In continuous underload condition, the underload alarm (A-LL) is reported when the run time is reached.	60.0s	<input type="radio"/>
P15.20	Current detection value at underload running	0.0%: Automatic detection on underload 0.1–100.0% The value 0.0% indicates it is determined by the underload detection mechanism of the inverter. A value rather than 0.0% indicates it is determined by P15.20 . 100.0% corresponds to the motor rated current. When the absolute value of target frequency minus ramp frequency is less than or equal to P15.22 (lag frequency threshold): If the actual current value at the actual frequency is continuously less than P15.20 , the system reports the underload fault with a delay specified by P15.19 . Otherwise, the system runs properly. In the non-continuous situation, the delay counter is automatically cleared.	00.00%	<input type="radio"/>
P15.21	Underload reset delay	0.0–1000.0s Underload reset delay. In underload state, the counting on the underload run time and that on the underload reset delay are performed	120.0s	<input type="radio"/>

Function code	Name	Description	Default	Modify
		synchronously. Generally, the value needs to be greater than P15.19 so that the system can report the underload alarm when the underload run time is reached and then reset can be performed when the time (P15.21–P15.19) elapsed. If the value of P15.21 is the same as that of P15.19, auto reset is performed at the same time as the underload alarm is reported.		
P15.22	Lag frequency threshold	0.00–200.00Hz P15.22 is the lag frequency threshold, used to determine the underload run condition. Currents are compared only when the absolute value of target frequency minus ramp frequency is continuously less than or equal to this parameter.	0.30Hz	<input type="radio"/>
P15.23	Weak-light delay	0.0–3600.0s Time setting on weak-light delay. When the output frequency is less than or equal to the PI output frequency lower limit and the delay counting is started, which reaches the weak-light delay time, the system reports the weak-light alarm (A-LS) and then sleeps. In the non-continuous situation, the delay counter is automatically cleared. Note: When the bus voltage is lower than the undervoltage point or the PV voltage is lower than 70V, the system directly reports the weak-light alarm without any delay. When P15.32 =0, in weak-light condition, the system automatically switch to the power-frequency input mode.	100.0s	<input type="radio"/>

Function code	Name	Description	Default	Modify
P15.24	Weak-light wake-up delay	0.0–3600.0s Time setting on weak-light wake-up delay. If the weak-light pre-alarm is reported, the system clears the pre-alarm with the weak-light wake-up delay and then re-enters the running state. When P15.32 =0, if the PV voltage is greater than P15.34 , the system switches from the power-frequency input mode to the PV input mode with the weak-light wake-up delay.	300.0s	<input type="radio"/>
P15.25	Initial actual reference voltage display	0.0–2000.0V	0	<input checked="" type="radio"/>
P15.26	Min. reference voltage in max. power tracking	0.00–1.00 Used to set the min. reference voltage in max. power tracking. Min. reference voltage in max. power tracking = (PV module open-circuit voltage) * P15.26 PV module open-circuit voltage = P15.25 + P15.28 Track the max. power in the range of Min. reference voltage in max. power tracking— P15.27 . P15.27 must be greater than the min. reference voltage. A smaller difference between them indicates a smaller range, which means faster tracking. The voltage corresponding to the max. power must be within the range. P15.26 and P15.27 must be adjusted according to the site situation.	0.70	<input type="radio"/>

Function code	Name	Description	Default	Modify						
P15.27	Max. reference voltage in max. power tracking	<p>Min. reference voltage in max. power tracking—P15.31 It is the max. voltage tracked when MPPT max. power tracking is valid.</p> <table border="1"> <thead> <tr> <th>Model</th> <th>Max. voltage in max. power tracking</th> </tr> </thead> <tbody> <tr> <td>2.2kW</td> <td>400.0V</td> </tr> <tr> <td>4–7.5kW</td> <td>750.0V</td> </tr> </tbody> </table>	Model	Max. voltage in max. power tracking	2.2kW	400.0V	4–7.5kW	750.0V	Model depended	<input type="radio"/>
Model	Max. voltage in max. power tracking									
2.2kW	400.0V									
4–7.5kW	750.0V									
P15.28	Adjustment of initial reference voltage	<p>0.0–200.0V MPPT starts to be disturbed from the initial reference voltage. Initial reference voltage=PV voltage – P15.28</p>	5.0V	<input type="radio"/>						
P15.29	Auto adjustment interval of Vmppt upper/lower limit	<p>0.0–10.0s When P15.29=0.0, auto adjustment of Vmppt upper/lower limit is invalid. When it is not 0.0, Vmppt upper/lower limit is automatically adjusted at an interval specified by P15.29. The center after the adjustment is the actual PV voltage, and the upper/lower limit adjustment range is P15.30. That is: Max./Min. Reference voltage = (Actual PV voltage ± P15.30 This will be automatically updated to P15.26 and P15.27.</p>	1.0s	<input type="radio"/>						
P15.30	Auto adjustment range of Vmppt upper/lower limit	<p>1.0–100.0V Range in which Vmppt upper/lower limit can be automatically adjusted.</p>	30.0V	<input type="radio"/>						

Function code	Name	Description	Default	Modify						
P15.31	Vmppt max. value	<p>P15.27–6553.5V</p> <p>During the max. power tracking, the PV module reference voltage upper limit will not exceed the value of P15.31.</p> <p>The factory value depends:</p> <table border="1"> <thead> <tr> <th>Model</th> <th>MPPT default value</th> </tr> </thead> <tbody> <tr> <td>2.2kW</td> <td>400.0V</td> </tr> <tr> <td>4–7.5kW</td> <td>750.0V</td> </tr> </tbody> </table>	Model	MPPT default value	2.2kW	400.0V	4–7.5kW	750.0V	Model depended	<input type="radio"/>
Model	MPPT default value									
2.2kW	400.0V									
4–7.5kW	750.0V									
P15.35	Rated pump flow	The pump flow is Q_N when the pump runs at the rated frequency and lift. Unit: m ³ /h	0.0	<input type="radio"/>						
P15.36	Rated pump lift	The pump lift is H_N when the pump runs at the rated frequency and flow. Unit: meter	0.0	<input type="radio"/>						
P15.37	PV undervoltage point	<p>When the PV voltage is less than the value of this parameter, the system reports the PV undervoltage fault.</p> <p>The factory value depends on the model.</p> <table border="1"> <thead> <tr> <th>Model</th> <th>PV undervoltage point</th> </tr> </thead> <tbody> <tr> <td>2.2kW</td> <td>70.0V</td> </tr> <tr> <td>4–7.5kW</td> <td>240.0V</td> </tr> </tbody> </table> <p>Setting range: 0.0–400.0</p>	Model	PV undervoltage point	2.2kW	70.0V	4–7.5kW	240.0V	Model depended	<input type="radio"/>
Model	PV undervoltage point									
2.2kW	70.0V									
4–7.5kW	240.0V									

P17 group Status viewing

Function code	Name	Description	Default	Modify
P17.00	Set frequency	0.00Hz–P00.03	0.00Hz	●
P17.01	Output frequency	0.00Hz–P00.03	0.00Hz	●
P17.02	Ramp reference frequency	0.00Hz–P00.03	0.00Hz	●
P17.03	Output voltage	0–1200V	0V	●
P17.04	Output current	0.0–3000.0A	0.0A	●

Function code	Name	Description	Default	Modify
P17.05	Motor rotation speed	0–65535RPM	0 RPM	●
P17.11	DC bus voltage	0.0–2000.0V	0V	●
P17.12	Digital input terminal status	0x0–0xF Bit 0 corresponds to S1. Bit 1 corresponds to S2.	0x0	●
P17.13	Digital output terminal status	0x0–0xF Bit 0 corresponds to RO1.	0x0	●

P18 group Status viewing functions special for solar inverter

Function code	Name	Description	Default	Modify
P18.00	PV reference voltage	MPPT is performed at the inverter side. The value is given by the inverter side.	0.0V	●
P18.01	Actual PV voltage	DC input voltage (V)	0.0V	●
P18.03	Actual PV current	DC input current (A)	0.00A	●
P18.07	PV input power	Reserved. Unit: kW	0.00kW	●
P18.11	Actual pump flow	$Q = Q_N * f / f_N$ Unit: m ³ /h	0.0m ³ /h	●
P18.12	Actual pump lift	$H = 0.9H_N * (f / f_N)^2$ Unit: m	0.0m	●
P18.13	High-order bits in total pump flow	Used to display the 16 high-order bits of the total pump flow. Unit: m ³	0	●
P18.14	Low-order bits in total pump flow	Used to display the 16 low-order bits of the total pump flow. Unit: m ³ Total pump flow = P18.13 *65535 + P18.14	0.0	●
P18.15	Reset total pump flow	When it is set to 1, the total pump flow can be reset. P18.13 and P18.14 are cleared and then accumulated again. After the resetting succeeds, P18.15 is automatically changed to 0.	0	◎

Function code	Name	Description	Default	Modify
P18.17	High-order bits in total power supply amount	Used to display the 16 high-order bits of the total power supply amount. Unit: kWh	0	●
P18.18	Low-order bits in total power supply amount	Used to display the 16 low-order bits of the total power supply amount. Unit: kWh Total power supply amount = $P18.17 * 65535 + P18.18$	0.0kWh	●
P18.19	Reset total power supply amount	When it is set to 1, the total power supply amount can be reset. P18.17 and P18.18 are cleared and then accumulated again. After the resetting succeeds, P18.19 is automatically changed to 0.	0	◎
P18.21	High-order bits of duration of this run	Used to display the 16 high-order bits of duration of this run. Unit: min	0	●
P18.22	Low-order bits of duration of this run	Used to display the 16 low-order bits of duration of this run. Unit: min Duration of this run = $P18.21 * 65535 + P18.22$	0.0min	●
P18.23	Reset duration of this run	When it is set to 1, the duration of this run can be reset. P18.21 and P18.22 are cleared and then accumulated again. After the resetting succeeds, P18.23 is automatically changed to 0.	0	◎

Note:

- The duration from when the inverter starts to when it runs at the PI output frequency lower limit is determined by the ACC time.
- Delay time counting follows the rules if multiple fault conditions are met simultaneously: For example, if all fault conditions of weak light, full water, and underload are met simultaneously, the delay time for each fault is counted independently. When the delay time of a fault is reached, the fault is reported. The delay time counting for the other two faults is kept. If the reported faults is resolved by the conditions of the other two faults persist, the delay time counting of the other two faults continues. If a fault condition is not met during counting, the delay time of this fault is cleared.

7 Fault diagnosis and solution

Do as follows if the inverter encounters a fault:

1. Check whether there is any exception on the keypad. If yes, contact the local INVT office.
2. If no, check function group P07 to view the fault record parameters and understand the actual condition.
3. See the following table for a detailed solution and check for exceptions.
4. Rectify the fault or ask for help.
5. Ensure the fault has been rectified, perform fault reset, and run the inverter again.

Fault code	Fault type	Possible cause	Solution
OV1	Overvoltage during ACC	<ul style="list-style-type: none"> • The input voltage is abnormal. • There is large energy feedback. • No braking components. • Energy-consumption braking is not enabled. 	<ul style="list-style-type: none"> • Check the input power. • Check whether the loaded DEC time is too short or the inverter starts when the motor is rotating. • Install the braking components. • Check the setting of related function codes.
OV2	Overvoltage during DEC		
OV3	Overvoltage during constant speed running		
OC1	Overcurrent during ACC	<ul style="list-style-type: none"> • The acceleration or deceleration is too fast. • The voltage of the grid is too low. • The power of the inverter is too low. • The load transients or is abnormal. • There is to-ground short circuit or output phase loss. • There is strong external interference. • The overvoltage stall protection is not enabled. 	<ul style="list-style-type: none"> • Increase the ACC time. • Check the input power. • Select the inverter with larger power. • Check whether there is short circuit (to-ground or inter-wire) in the load or the rotation is not smooth. • Check the output wiring. • Check whether there is strong interference. • Check the setting of related function codes.
OC2	Overcurrent during DEC		
OC3	Overcurrent during constant speed running		

Fault code	Fault type	Possible cause	Solution
UV	Bus undervoltage fault	<ul style="list-style-type: none"> • The voltage of the grid is too low. • The overvoltage stall protection is not enabled. 	<ul style="list-style-type: none"> • Check the grid input power supply. • Check the setting of related function codes.
OL1	Motor overload	<ul style="list-style-type: none"> • The grid voltage is too low. • The motor rated current is set incorrectly. • The motor stall occurs or the load transient is too large. 	<ul style="list-style-type: none"> • Check the grid voltage. • Reset the motor rated current. • Check the load and adjust the torque boost quantity.
OL2	Inverter overload	<ul style="list-style-type: none"> • The ACC is too fast. • The rotating motor is reset. • The grid voltage is too low. • The load is too heavy. • The motor power is too small. 	<ul style="list-style-type: none"> • Increase the ACC time. • Avoid the restarting after stop. • Check the grid voltage. • Select an inverter with larger power. • Select a proper motor.
SPO	Phase loss on output side	<ul style="list-style-type: none"> • Phase loss output occurs to U, V, W (or the three phases of the load are seriously asymmetrical). 	<ul style="list-style-type: none"> • Check the output wiring. • Check the motor and cables.
OH2	Inverter module overheat	<ul style="list-style-type: none"> • Air duct jam or fan damage occurs. • Ambient temperature is too high. • The time of overload running is too long. 	<ul style="list-style-type: none"> • Dredge the vent duct or replace the fan. • Lower the ambient temperature.
EF	External fault	<ul style="list-style-type: none"> • SI external faulty input terminal action. 	<ul style="list-style-type: none"> • Check external device input.
CE	RS485 communication fault	<ul style="list-style-type: none"> • The baud rate setting is incorrect. • A fault occurs to the 	<ul style="list-style-type: none"> • Set a proper baud rate. • Check the communication

Fault code	Fault type	Possible cause	Solution
		communication wiring. <ul style="list-style-type: none"> • The communication address is incorrect. • There is strong interference to the communication. 	interface wiring. <ul style="list-style-type: none"> • Set a proper communication address. • Change or replace the wire or improve the anti-interference capability.
ItE	Current detection fault	<ul style="list-style-type: none"> • The control board connector is in poor contact. • Hall device is damaged. • An exception occurs on the magnifying circuit. 	<ul style="list-style-type: none"> • Check the connector and re-plug. • Replace the Hall device. • Change the main control board.
tE	Motor autotuning fault	<ul style="list-style-type: none"> • The motor capacity does not match the inverter capacity. • Motor parameters are not set correctly. • The difference between the parameters obtained from autotuning and the standard ones is great. • Autotuning timed out. 	<ul style="list-style-type: none"> • Change the inverter model. • Set the motor type and nameplate parameters correctly. • Empty the motor load. • Check the motor wiring and parameter settings. • Check whether the upper limit frequency is higher than 2/3 of the rated frequency.
EEP	EEPROM operation error	<ul style="list-style-type: none"> • Error in reading or writing control parameters. • The EEPROM is damaged. 	<ul style="list-style-type: none"> • Press STOP/RST for reset. • Change the main control board.
END	Running time reached	<ul style="list-style-type: none"> • The actual running time of the inverter is longer than the internal set running time. 	<ul style="list-style-type: none"> • Ask for the supplier and adjust the set running time.

Fault code	Fault type	Possible cause	Solution
OL3	Electronic overload fault	<ul style="list-style-type: none"> The inverter reports overload pre-alarm according to the setting. 	<ul style="list-style-type: none"> Check the load and the overload pre-alarm points.
ETH1	To-ground short-circuit fault 1	<ul style="list-style-type: none"> The output of the inverter is short circuited to the ground. There is a fault in the current detection circuit. 	<ul style="list-style-type: none"> Check whether the motor wiring is normal. Replace the Hall device. Change the main control board.
ETH2	To-ground short-circuit fault 2		
dEu	Speed deviation fault	<ul style="list-style-type: none"> The load is too heavy or stalled. 	<ul style="list-style-type: none"> Check the load and increase the detection time if the load is normal. Check whether control parameters are set correctly.
STo	Mal-adjustment fault	<ul style="list-style-type: none"> SM control parameters are set incorrectly. Autotuned parameters are not accurate. The inverter is not connected to the motor. 	<ul style="list-style-type: none"> Check the load and ensure the load is normal. Check whether control parameters are set correctly. Increase the mal-adjustment detection time.
LL	Electronic underload fault	<ul style="list-style-type: none"> The inverter reports underload pre-alarm according to the setting. 	<ul style="list-style-type: none"> Check the load and the underload pre-alarm points.
A-LS	Weak-light pre-alarm	<ul style="list-style-type: none"> The sunlight is weak or the PV module configuration is insufficient. 	<ul style="list-style-type: none"> The device will automatically run when the light is sufficient. Check whether the PV module configuration is sufficient.

Fault code	Fault type	Possible cause	Solution
A-LL	Underload pre-alarm	<ul style="list-style-type: none"> • The pumping pool has no water. 	<ul style="list-style-type: none"> • Check the pumping pool.
A-tF	Full-water pre-alarm	<ul style="list-style-type: none"> • The pumping pool is full. 	<ul style="list-style-type: none"> • If you have configured the full-water pre-alarm function, the device automatically stops when the pre-alarm elapsed a period of time. Otherwise, check whether terminals are wired correctly.
A-tL	Empty-water pre-alarm	<ul style="list-style-type: none"> • The pumping pool has no water. 	<ul style="list-style-type: none"> • If you have configured the empty-water pre-alarm function, the device automatically stops when the pre-alarm elapsed a period of time. Otherwise, check whether terminals are wired correctly.

Appendix A Options

A.1 RMS and monitoring app

A.1.1 Product overview

INVT EC series RMS expansion card is an IoT wireless data terminal, using public carrier networks to provide wireless long-distance data transmission. The stability and reliability meet industrial application scenarios.

The product adopts a high-performance industrial-grade 16- or 32-bit communication processor and industrial-grade wireless module, with an embedded real-time operating system as the software support platform, and also provides RS485 interfaces to directly connect to serial devices, thus achieving transparent data transmission.

A.1.1.1 Product features

Standard and easy to use

- Provides standard RS485 interfaces for direct connection to serial devices for data acquisition.
- Intelligent data terminal, able to enter the data transmission state once upon power-on.
- With powerful center management software, facilitating device management. (Optional)
- Easy system configuration and maintenance interface.

Powerful functions

- Provides standard TTL interfaces to allow local software upgrade.
- Supports OTA remote wireless upgrade and remote policy configuration.
- Supports cloud-platform management on devices, facilitating remote management and device intelligence.
- Embedded with standard TCP/IP protocol stacks, supporting multiple transmission protocols.
- Supports APN.
- Able to directly connect to serial devices, supporting up to 40 groups of Modbus register collection for terminal devices.
- Supports the configuration of Modbus query address and collection period to upload only changed data, achieving the traffic saving on data upload.
- Supports SIM cards. (Optional)
- Supports base station positioning.

- Supports GPS positioning to obtain device positions accurately (optional).
- Supports the use of cell for timing upon power failure. (Optional)
- Supports the use of SD card for data collection. (Optional)
- Supports the use of LCD to display data collection and status. (Optional)

A.1.2 Installation and delivery

A.1.2.1 Overview

EC series RMS expansion cards must be installed properly to achieve the designed function. Generally, the installation must be done under the guidance of our certified and qualified engineers.

Note: Do not install EC series RMS expansion cards with the power on.

A.1.2.2 Unpacking inspection

Before unpacking the RMS expansion card packing box, check whether the product information on the order is consistent with that on the packing box and whether the packaging is intact. After unpacking the box, please keep the packaging materials for possible future use of transfer. If you have any questions, please contact the supplier in time.

Delivery item	Qty	Remarks
RMS expansion card	1	/
GSM antenna	1	Applicable only to models using an external antenna
GPS antenna	1	Optional
LCD	1	Optional
PIN port	1	4-pin

A.2 Cable

A.2.1 Power cable

The sizes of the input power cables and motor cables must comply with local regulations.

Note: If the electrical conductivity of the motor cable shield layer does not meet the requirements, a separate PE conductor must be used.

A.2.2 Control cable

A relay cable needs to carry the metal braided shield layer.

The keypad needs to be connected by using a network cable. In complicated electromagnetic environments, a shielded network cable is recommended.

A shielded twisted-pair cable is recommended for a communication cable.

Note:

- Analog signals and digital signals cannot share a same cable, and their cables must be routed separately.
- Before connecting the input power cable of the inverter, check the insulation conditions of the cable according to local regulations.

Recommended power cable sizes for standard inverter models

Inverter model	Recommended cable size (mm ²)	
	PV+/PV-, U/V/W	PE
SPC2K2TR20	2.5	2.5
SPC2K2TR26-S	2.5	2.5
SPC2K2TR26-H	2.5	2.5
SPC004TR40	2.5	2.5
SPC004TR46-S	2.5	2.5
SPC004TR46-H	2.5	2.5
SPC7K5TR40	4	4
SPC7K5TR46-S	4	4
SPC7K5TR46-H	4	4

Note:

- The cables recommended for the main circuit can be used in scenarios where the ambient temperature is lower than 40°C, the wiring distance is shorter than 100 m, and the current is the rated current.
- If the control cable and power cable must be crossed, the angle between the control cable and power cable must be 90 degrees.
- If the inside of motor is moist, the insulation resistance is reduced. If you suspect the inside of motor is moist, dry and re-measure the motor.

A.3 Reactor

When the distance between the inverter and motor is longer than 50 m, the parasitic capacitance between the long cable and ground may cause large leakage current, and overcurrent protection of the inverter may be frequently triggered. To prevent this from happening and avoid damage to the motor insulator, compensation must be made by adding an output reactor. When the inverter is used to drive multiple motors, take the total length of the motor cables (that is, sum of the lengths of the motor cables) into account. When the total length is longer than 50 m, an output reactor must be added on the output side of the inverter. When the distance between the inverter and motor ranges from 50 m to 100 m, select the reactor according to the following table. If the distance is longer than 100 m, contact INVT's technical support technicians.

Output reactor model selection

Inverter model	Output reactor
SPC2K2TR20	OCL2-004-4
SPC2K2TR26-S	OCL2-004-4
SPC2K2TR26-H	OCL2-004-4
SPC004TR40	OCL2-004-4
SPC004TR46-S	OCL2-004-4
SPC004TR46-H	OCL2-004-4
SPC7K5TR40	OCL2-7R5-4
SPC7K5TR46-S	OCL2-7R5-4
SPC7K5TR46-H	OCL2-7R5-4

Note:

- The rated output voltage drop of output reactors is 1%±15%.
- All the options in the preceding table are externally configured. You need to specify whether the options are externally configured in your purchase order.

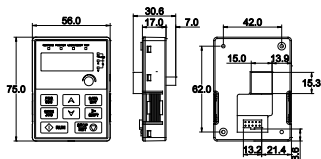
Appendix B Recommended PV module configuration

B.1 PV module configuration recommended by inverter model

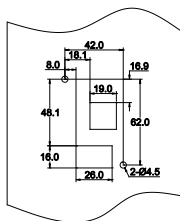
Inverter model	Open-circuit voltage class of PV module			
	37±1V		45±1V	
	Module power ± 5Wp	Modules per string * Strings	Module power ± 5Wp	Modules per string * Strings
SPC2K2TR20	250	11*1	300	9*1
SPC2K2TR26-S	250	11*1	300	9*1
SPC2K2TR26-H	250	11*1	300	9*1
SPC004TR40	250	20*1	300	16*1
SPC004TR46-S	250	20*1	300	16*1
SPC004TR46-H	250	20*1	300	16*1
SPC7K5TR40	250	18*2	300	15*2
SPC7K5TR46-S	250	18*2	300	15*2
SPC7K5TR46-H	250	18*2	300	15*2

Appendix C Dimension drawings

C.1 External keypad structure

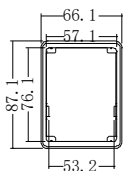


Keypad outline drawing

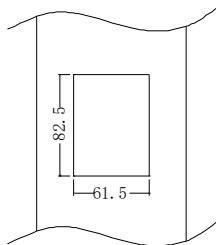


Keypad cut-out drawing (without bracket)

You can mount the keypad on an external bracket, which is an optional part. The external keypad can be up to 20 meters away from the inverter.



Keypad bracket



Installation dimensions

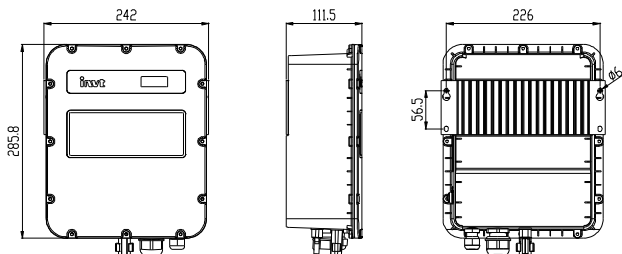
C.2 Dimensions of 2.2–7.5kW models

Figure C-1 Dimensions of 2.2–4kW models

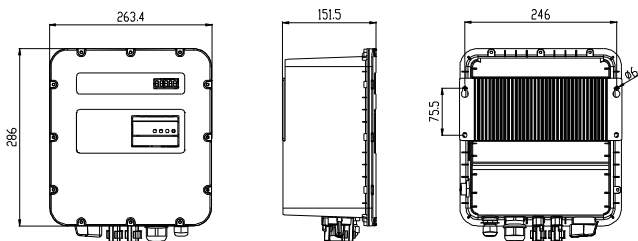


Figure C-2 Dimensions of 7.5kW model

Appendix D Further information

D.1 Product and service queries

If you have any queries about the product, contact the local INVT office. Please provide the model and serial number of the product you query about. You can visit www.invt.com to find a list of INVT offices.

D.2 Feedback on INVT inverter manuals

Your comments on our manuals are welcome. Please visit www.invt.com, directly contact online service personnel or choose **Contact Us** to obtain contact information.

D.3 Documents on the Internet

You can find manuals and other product documents in the PDF format on the Internet. Please visit www.invt.com, and choose **Support > Download**.



Service line: 86-755-23535967 E-mail: overseas@invt.com.cn Website: www.invt.com

The products are owned by **Shenzhen INVT Electric Co.,Ltd.**

Two companies are commissioned to manufacture: (For product code, refer to the 2nd/3rd place of S/N on the name plate.)

Shenzhen INVT Electric Co.,Ltd. (origin code: 01)

Address: INVT Guangming Technology Building, Songbai Road,
Matian, Guangming District, Shenzhen, China

INVT Power Electronics (Suzhou) Co.,Ltd. (origin code: 06)

Address: No. 1 Kunlun Mountain Road, Science & Technology
Town, Gaoxin District, Suzhou, Jiangsu, China

Industrial Automation: HMI

Elevator Intelligent Control System

Energy & Power: UPS

New Energy Vehicle Powertrain System

New Energy Vehicle Motor

PLC

Rail Transit Traction System

DCIM

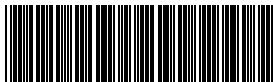
New Energy Vehicle Charging System

VFD

Solar Inverter

Servo System

SVG



66001-00785